

NOVOLUX  
LIGHTING

2019

exo  
lighting  
decorative indoor



# NOVOLUX

LIGHTING

Este catálogo no constituye oferta en firme de los productos, para más información diríjense a:  
This catalogue does not constitute a definite offer for sale of any of the products. For further information please contact:  
Ce catalogue ne fournit pas une offre définitive des produits, pour plus d'informations adressez-vous à:  
O presente catálogo não constitui uma oferta firme dos produtos, para mais informações contacte:

GRUPO GESTIÓN INTEGRAL NOVOLUX INTERNACIONAL, SL.

C/ Ramón Berenquer, 8 (Polígono Industrial Can Vinçals)

08130 Sta. Perpètua de la Mogoda - BARCELONA - España

ESPAÑA - PORTUGAL: Tel +34 93 274 52 52

FRANCE: 0800 918 906

REST OF THE WORLD: Tel +34 93 516 20 05

Fax +34 93 346 37 51 / 93 311 45 46 - [info@gruponovolux.com](mailto:info@gruponovolux.com)

[www.gruponovolux.com](http://www.gruponovolux.com)



Desde  
Barcelona  
hacia el  
**Mundo**

Desde 1981. dedicados plenamente a la luz.

# Presencia internacional en 40 países

Trabajo con equipo local para iluminar todo el mundo gracias a una estable cooperación con una sólida red establecida de partners locales y distribuidores en Europa, Oriente Medio, Latinoamérica, África y Asia.



# Nuestras Marcas

## & Categorías de Producto

Más de 3.700 luminarias contemporáneas y de confianza clasificadas en 4 marcas



**Cristher**  
lighting

architectural outdoor

Gama para exteriores  
residenciales y arquitecturales



**Dopo**  
lighting

residential outdoor

Gama para exterior  
funcional y esencial



**exo**  
lighting

decorative indoor

Interior versátil y decorativo con  
enfoque a hospitality y contract



**indeluz**  
lighting

technical indoor

Interior técnica para espacios  
comerciales, hoteleros y oficinas

# Pasión

por lo que hacemos,  
más allá de la iluminación

60 profesionales comprometidos y amantes de la luz, incluyendo Ingenieros,  
arquitectos y técnicos para ayudarte en tus próximos proyectos de iluminación



Miembros activos en Asociaciones de Iluminación y expositores en ferias

light+building

FEDAI  
LIGHTING TEAM SPAIN

Lighting Spain



secartys

inter\*HOTEL

MATELEC

# Diseñando para seducirte



**NELL**  
By NOVOLLUX  
Technical Studio



**KAI**  
By NOVOLLUX  
Technical Studio



**DIAGONAL**  
By Nacho Timón



**DION**  
By Jordi Blas





# Queremos **iluminar** tus proyectos

Somos un proveedor global con una amplia y completa gama de luminarias contemporáneas y de calidad para un amplio espectro de soluciones y aplicaciones lumínicas.





Residencial  
Hospitality



Oficinas  
Retail



# División Custom Lighting

División para el diseño y la fabricación de soluciones personalizadas de iluminación para proyectos y aplicaciones de hospitality y contract.

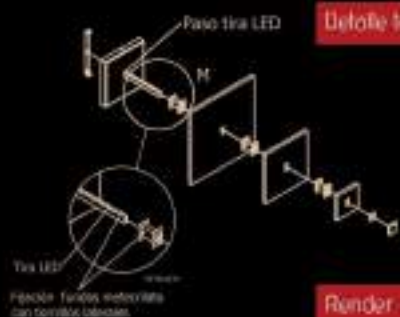

Detalle técnico

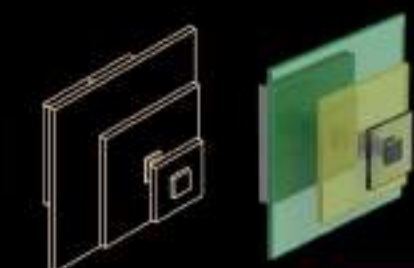

Render



Prototipo

Instalación real

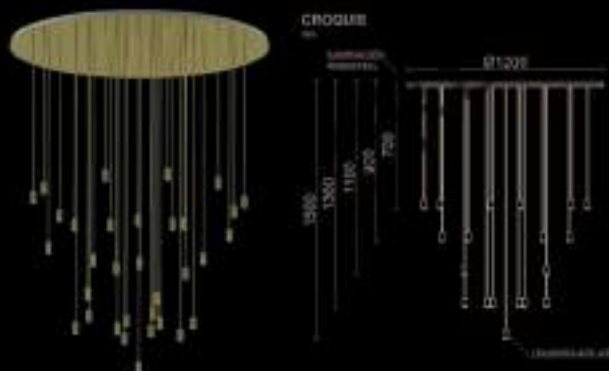

Detalle técnico



## Instalaciones de **12.000 m<sup>2</sup>** que incluyen:

- Oficina Central
- Showroom
- Centro logístico con almacén con capacidad para 10.000 pallets de almacenamiento con un servicio rápido de entrega: +200 pedidos enviados al día.
- Laboratorio interno para controles técnicos y de calidad.
- Zona de montaje, metal y ensamblaje.
- Ingeniería especializada en diseño industrial y I+D
- Además, centros de producción descentralizados donde aplicamos estrictos controles de calidad en todas las fases del proceso de producción, así como en el producto acabado.
- Procesos de calidad ISO 9001:2018 aprobada por la empresa IQNet & AENOR.



SUPERFÍCIE / SURFACE / SAILLIE / SALIENTE

<p><b>new</b> DIAGONAL</p> <p>26</p> <p>106 176 178</p>	<p><b>N</b> WOOD</p> <p>28</p> <p>204 204</p>	<p><b>new</b> AMSTERDAM</p> <p>30</p> <p>186 186</p>	<p><b>new</b> VORADA</p> <p>31</p> <p>32</p> <p>32 114</p>		
<p>KASHA</p> <p>34</p> <p>121</p>	<p>BRITTA</p> <p>34</p> <p>208 208</p>	<p><b>new</b> KAI</p> <p>35</p> <p>180 180</p>	<p><b>N</b> EASY</p> <p>36</p>	<p>FIRENZE</p> <p>38</p> <p>120 188 188</p> <p>USB</p>	
<p><b>N</b> OVAL</p> <p>42</p> <p>118 192 194</p>	<p>GINA</p> <p>48</p> <p>196 197</p>	<p>A TU ESTILO</p> <p>50</p> <p>122</p>	<p>BAY</p> <p>53</p>	<p>NUNO</p> <p>54</p>	
<p>MONNET</p> <p>55</p>	<p>VERONA</p> <p>56</p>	<p>BEARN</p> <p>57</p>	<p>EDA</p> <p>58</p> <p>190 190</p>	<p>TOSCANA</p> <p>59</p> <p>LED</p>	<p>DIRK</p> <p>59</p> <p>LED</p>
<p>SPOT</p> <p>60</p> <p>LED</p>	<p>LECTOR</p> <p>60</p> <p>LED</p>	<p>DORÉS</p> <p>61</p> <p>LED</p>	<p>BALTIC</p> <p>62</p> <p>LED</p> <p>USB</p>	<p><b>new</b> MONTECARLO</p> <p>64</p> <p>225</p> <p>USB</p>	
<p>ELFI</p> <p>65</p> <p>LED</p>	<p>LEIDEN</p> <p>66</p> <p>LED</p> <p>USB</p>	<p>OLVAS</p> <p>67</p> <p>LED</p>	<p>JULIA</p> <p>68</p> <p>LED</p>	<p>BOOK</p> <p>68</p> <p>232</p> <p>LED</p>	

<p>LORE 70</p>  <p>LED</p>	<p>TABEL 70</p>  <p>LED</p>	<p>CLOÉ 72</p>  <p>156 218 218</p>	<p>VALAN 72</p>  <p>160 224</p>	<p>DIDEN 74</p>  <p>LED</p>	
<p>ELKE 74</p>  <p>LED</p>	<p>DENAR 76</p>  <p>LED</p>	<p>NUCIR 76</p>  <p>LED</p>	<p><b>new</b> TANIA 77</p>  <p>108</p>	<p>BRICK 78</p>  <p>LED</p>	<p>SHADOW 80</p>  <p>LED</p>
<p>IONA 81</p>  <p>LED</p>	<p>RETT 82</p>  <p>LED</p>	<p>DENEB 84</p>  <p>LED</p>	<p>CLUNY 84</p>  <p>LED</p>	<p>REMY 86</p>  <p>LED</p>	<p>SHEIBE 87</p>  <p>LED</p>
<p>IV 87</p>  <p>LED</p>	<p>ALIYA 88</p>  <p>148</p>	<p>RIBBON 89</p>  <p>LED</p>	<p>PYRAMID 90</p>  <p>LED</p>	<p>ESPIGA 91</p>  <p>LED</p>	<p>VOLLMOND 91</p>  <p>LED</p>
<p>CIRCUS 88</p>  <p>LED</p>	<p>MENKAR 93</p>  <p>LED</p>	<p>FINN 94</p>  <p>LED</p>	<p>AURORA 94</p>  <p>LED</p>	<p>TOLIMAN 95</p>  <p>LED</p>	<p>FRED 96</p>  <p>149</p>
<p>CUBI 98</p>  <p>LED</p>	<p>CLEAR 99</p>  <p>LED</p>	<p>SIKER 100</p>  <p>LED</p>	<p>LARI 101</p>  <p>LED</p>	<p>BORGO 102</p>  <p>LED</p>	<p>CARPI 103</p>  <p>LED</p>

SUSPENSIÓN / PENDANT / SUSPENSION / SUSPENSÃO

<p><b>new</b> <b>DIAGONAL</b>   </p> <p><b>106</b> 26 176 178</p> 	<p><b>new</b> <b>TANIA</b> </p> <p><b>108</b> 77</p> 	<p><b>SELMA</b></p> <p><b>110</b></p> 	<p><b>new</b> <b>VORADA</b>  </p> <p><b>114</b> 31 32</p> 	<p><b>new</b> <b>CORA</b></p> <p><b>116</b></p> 	
<p><b>N</b> <b>OVAL</b>   </p> <p><b>118</b> 42 192 194</p> 	<p><b>N</b> <b>FIRENZE</b>   </p> <p><b>120</b> 38 188 188</p> 	<p><b>KASHA</b> </p> <p><b>121</b> 34</p> 	<p><b>A TU ESTILO</b>  </p> <p><b>122</b> 50 52</p> 	<p><b>VIMET</b></p> <p><b>126</b></p> 	
<p><b>CUSKA</b></p> <p><b>128</b></p> 	<p><b>TESS</b>  </p> <p><b>130</b> 182 182</p> 	<p><b>BAGUET</b></p> <p><b>132</b></p> 	<p><b>ELGA</b></p> <p><b>134</b></p> 	<p><b>FLAVIA</b></p> <p><b>136</b></p> 	<p><b>SIRA</b></p> <p><b>138</b></p> 
<p><b>BETON</b></p> <p><b>140</b></p> 	<p><b>NAE</b></p> <p><b>142</b></p>  <p><b>LED</b></p>	<p><b>DORA</b></p> <p><b>144</b></p> 	<p><b>EYRA GLASS</b></p> <p><b>145</b></p> 	<p><b>BRENDA</b></p> <p><b>146</b></p> 	<p><b>CUPERTINO</b></p> <p><b>146</b></p>  <p><b>LED</b></p>
<p><b>GILDA</b></p> <p><b>147</b></p>  <p><b>LED</b></p>	<p><b>ALIYA</b> </p> <p><b>148</b> 88</p>  <p><b>LED</b></p>	<p><b>FRED</b> </p> <p><b>149</b> 96</p> 	<p><b>A TU ESTILO</b></p> <p><b>150</b></p> 	<p><b>SELENE</b></p> <p><b>152</b></p> 	<p><b>APRILLA</b></p> <p><b>154</b></p> 
<p><b>KAIRA</b></p> <p><b>155</b></p> 	<p><b>CLOÉ</b>   </p> <p><b>156</b> 72 218 218</p> 	<p><b>LÍRICA</b></p> <p><b>158</b></p> 	<p><b>VALAN</b>  </p> <p><b>160</b> 72 224</p> 	<p><b>LACIO</b></p> <p><b>160</b></p> 	<p><b>ANTIQ</b></p> <p><b>162</b></p> 

VINTAGE

162



LIVIA

164



TANNA

166



**N** OLIVIA

168



BELL

168



CAMILA

170



MILDRED

171



DINA

172















LED

PIE Y SOBREMESA / FLOOR AND TABLE LAMPS / LAMPADAIRES ET LAMPES À POSER / PÉ E MESA

<p><b>new</b> DIAGONAL  </p> <p>176 26 106</p> 	<p><b>new</b> KAI  </p> <p>180 35</p> 	<p>TESS  </p> <p>182 130</p> 	<p><b>new</b> SINTRA  </p> <p>184</p> 	<p><b>new</b> AMSTERDAM  </p> <p>186 30</p> 	
<p><b>N</b> FIRENZE  </p> <p>188 38 120</p> 	<p>EDA  </p> <p>190 58</p> 	<p><b>N</b> OVAL  </p> <p>192 42 118</p> 	<p>GINA  </p> <p>196 48</p> 	<p>IRIS  </p> <p>198</p> 	
<p><b>new</b> IBAR </p> <p>200</p> 	<p>LARS </p> <p>202</p> 	<p><b>N</b> WOOD  </p> <p>204 28</p> 	<p>KARA </p> <p>206</p> 	<p>BRITTA  </p> <p>208 34</p> 	<p>GRAM </p> <p>210</p> 
<p><b>N</b> SPIN </p> <p>212</p> 	<p>ZANZIBAR </p> <p>214</p> 	<p>MAUI  </p> <p>216</p> 	<p>CLOÉ  </p> <p>218 72 156</p> 	<p>OMA </p> <p>220</p> 	<p>ASTRID </p> <p>222</p> 
<p>VALAN  </p> <p>224 72 160</p> 	<p><b>new</b> MONTECARLO  </p> <p>225 64</p> 	<p>SKANDIA </p> <p>226</p> 	<p>FOC </p> <p>228</p> 	<p>FLAMA </p> <p>229</p> 	<p>ALBERO </p> <p>230</p> 
<p>STUDY </p> <p>232</p> 	<p>BOOK  </p> <p>232 68</p> 				



<p><b>KRYSTAL</b> 237</p>  <p>LED</p>	<p><b>DIK</b> 238</p>  <p>LED</p>	<p><b>SUN</b> 238</p>  <p>LED</p>	<p><b>VEL</b> 240</p> 	<p><b>UVEG</b> 241</p> 	<p><b>BATH CLASSIC</b> 241</p> 
<p><b>FRISS</b> 242</p> 	<p><b>SHEID</b> 243</p>  <p>LED</p>	<p><b>LITS</b> 244</p>  <p>LED</p>	<p><b>DESIO</b> 245</p> 	<p><b>ALF</b> 246</p>  <p>LED</p>	<p><b>DOT</b> 246</p>  <p>LED</p>
<p><b>MOON</b> 247</p>  <p>LED</p>	<p><b>TEK</b> 248</p>  <p>LED</p>	<p><b>ALIN</b> 248</p>  <p>LED</p>	<p><b>TIEL</b> 250</p>  <p>LED</p>	<p><b>CARPI</b> 103</p> 	

VENTILADORES / CEILING FANS / VENTILATEURS / FÃS

<p><b>FUJIL</b> 254</p> 	<p><b>CEFIRO</b> 255</p>  <p>LED</p>	<p><b>VENTO</b> 256</p>  <p>LED</p>	<p><b>MARINADA</b> 258</p>  <p>LED</p>
---	---	--	---

## ACCESORIOS / ACCESSORIES / ACCESSOIRES / ACCESÓRIOS

## LED STRIP IN

262



## LED STRIP OUT

264



## SKOLL

266



## LED T2

271

**N** LED FILAMENT

272



## LED PRO

273



## G9

273



## LED MODUL

273



## CONNECTORS

274



## DETECTOR

274



## SENSOR

274



## HIMMEL

275

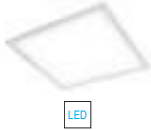

LED

## GIA

275



LED

## CARRIL

276



## POWER SUPPLIES

278



PANTALLAS  
SHADES  
ABAT-JOIRS  
ABAJURES

282



ACABADOS  
FINISHES  
FINITIONS  
ACABAMENTOS

284



MATERIALES  
MATERIALS  
MATÉRIAUX  
MATERIAIS

285

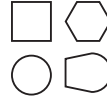

PICTOGRAFÍA  
SYMBOLOLOGY  
SYMBOLOLOGIE  
PICTOGRAFIA

286

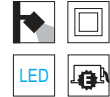

CONDICIONES DE VENTA / CONDIÇÕES DE VENTA

291

ÍNDICE DE REFERENCIAS / REFERENCE INDEX / INDEX RÉFÉRENCE / REFERÊNCIA ÍNDICE 297

# Colecciones / Collections / Collections / Coleções

new

## Diagonal



p. 26



p. 106



p. 176



p. 178



new

## Kai



p. 35



p. 180



p. 180



new

## Tania



p. 77



p. 108



new

## Amsterdam



p. 30



p. 186





p. 186



# Colecciones / Collections / Collections / Coleções

## **N** Wood

-  p. 28
-  p. 204
-  p. 204



## **new** Montecarlo

-  p. 64
-  p. 225







## **new** Vorada

-  p. 31
-  p. 32
-  p. 114





## **N** Oval

-  p. 42
-  p. 118
-   p. 192



# Colecciones / Collections / Collections / Coleções

## Book

 p. 68  
 p. 232

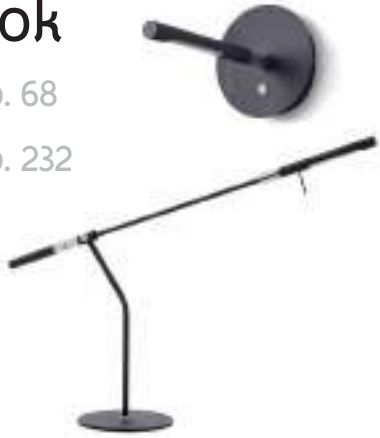



## Kasha

 p. 34  



## Tess

 p. 130  
  p. 182

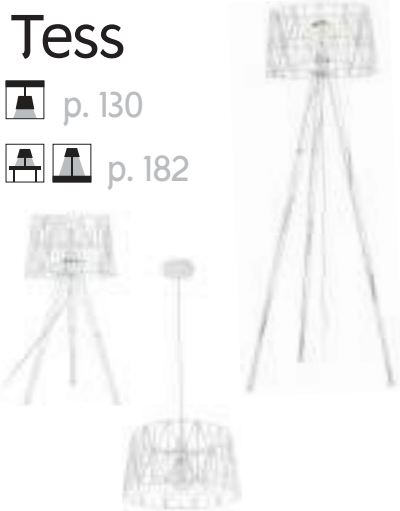





## Cloé

 p. 72  
 p. 156  
  p. 218



## Valan

 p. 72  
 p. 160  



## Aliya

 p. 88  
 p. 148



# Colecciones / Collections / Collections / Coleções

## Britta

 p. 34

  p. 208



## Eda

 p. 58

  p. 190



## A TU ESTILO

 p. 46

 p. 48

 p. 118



## N Gina

 p. 48

  p. 196



## N Firenze

 p. 38

 p. 120

  p. 188



# Índice de familias / Family index

## Index famille / Índice familia

### A

A Tu Estilo	50/52/122/124/150
Albero	230
Alf	246
Alimentadores	278/279
Alin	248
Aliya	88/148
Amsterdam	30/186
Antiq	162
Aprilla	154
Astrid	222
Aurora	94

### B

Baguet	132
Baltic	62
Bath Classic	241
Bay	53
Bearn	57
Bell	168
Beton	140
Book	68/232
Borgo	102
Brenda	146
Brick	78
Britta	34/208

### C

Camila	170
Carpi	103
Carril	276/277
Cefiro	255
Circus	92
Clear	99
Cloé	72/156/218
Cluny	84
Conectores	274
Cora	116
Cubi	98
Cupertino	146
Cuska	128

### D

Denar	76
Deneb	84
Desio	245
Detector	274

Diagonal	26/106/176/178
Diden	74
Dik	238
Dina	172
Dirk	59
Dora	144
Dorés	61
Dot	246

### E

Easy	36
Eda	58/190
Elfi	65
Elga	134
Elke	74
Espiga	91
Eyra Glass	145

### F

Finn	94
Firenze	38/40/120/188
Flama	229
Flavia	136
Foc	228
Fred	96/149
Friss	242
Fujil	254

### G

G9	273
Gia	275
Gilda	147
Gina	48/196/197
Gram	210

### H

Himmel	275
--------	-----

### I

Ibar	200
Iona	81
Iris	198/199
Iv	87

### J

Julia	68
-------	----



K	
Kai	35/180
Kaira	155/206
Kasha	34/121
Krystal	237

L	
Lacio	160
Lari	101
Lars	202
Lector	60
Led Filament	272
Led Modul	273
Led Pro	273
Led Strip In	262
Led Strip In Rgb	263
Led Strip Out	264
Led Strip Out Rgb	265
Led T2	271
Leiden	66
Lirica	158
Lits	244
Livia	164
Lore	70

M	
Marinada	258
Maui	216
Menkar	93
Mildred	171
Monnet	55
Montecarlo	64/225
Moon	247

N	
Nae	142
Nucir	76
Nuno	54

O	
Olivia	168
Olvas	67
Oma	220
Oval	42/44/46/118/192/194

P	
Pyramid	90

R	
Remy	86
Rett	82
Ribbon	89

S	
Selene	152
Selma	110/112
Sensor	274
Shadow	80
Sheibe	87
Sheid	243
Siker	100
Sintra	184
Sira	138
Skandia	226
Skoll	266/267/268/269/270
Spin	212
Spot	60
Study	232
Sun	238

T	
Tabel	70
Tania	77/108
Tanna	166
Tek	248
Tess	130/182
Tiel	250
Toliman	95
Toscana	59

U	
Uveg	241

V	
Valan	72/160/224
Vel	240
Vento	256
Verona	56
Vimet	126
Vintage	162
Vollmond	91
Vorada	31/32/114

W	
Wood	28/204

Z	
Zanzibar	214





Superficie  
Surface  
Saillie  
Saliente

new

# Diagonal



Pantalla no incluida / Shade not included / Abat-Jour exclu / Abajur não incluído



By Nacho Timón



855E-G05X 1A-01

855E-G05X 1A-02

855E-G05X 1A-37

E27 (Ø45) [Led / Fluo / Hal] max. 13W

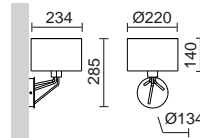

Pantallas disponibles / Available shades  
Abat-Jours disponibles / Abajures disponíveis

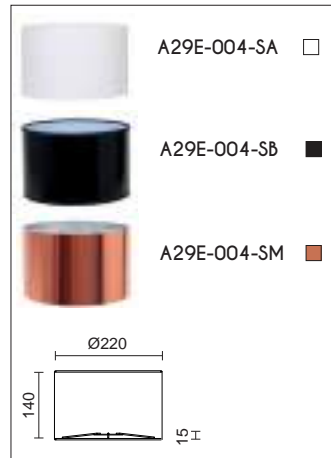

Lámpara recomendada  
Recommended lamp  
Lampe recommandé  
Lâmpada recomendada

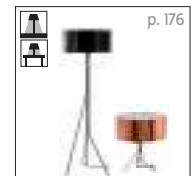
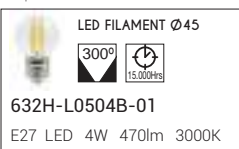



# Wood



Pantalla incluida / Shade included / Écran inclus / Abajur incluido



CA

**N** 621C-G05X1A-50-CA

**N** 621C-G05X1A-50-DC

**N** 621C-G05X1A-50-CG

E27 (Ø45) [Led / Fluo / Hal] max. 40W



DC



CG

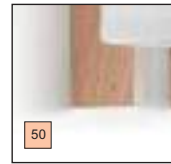
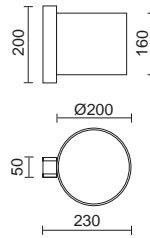

Làmpara recomendada  
Recommended lamp  
Lampe recommandé  
Lampada recomendada

**LED FILAMENT Ø45**

**300°**

**632H-L0504B-01 7 €**

E27 LED 4W 470lm 3000K





new

# Amsterdam



Pantalla incluida / Shade included / Écran inclus / Abajur incluido



CA

909C-G05X 1A-35-CA

909C-G05X 1A-35-CB

909C-G05X 1A-35-CG

E27 (Ø45) [Led / Fluo / Hal] max. 40W

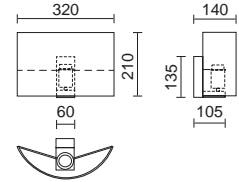

CB



CG

35

Làmpara recomendada  
Recommended lamp  
Lampe recommandé  
Lâmpada recomendada

LED FILAMENT Ø45

300° 15.000hrs

632H-L0504B-01 7 €

E27 LED 4W 470lm 3000K





# Vorada



new

Pantalla incluida / Shade included / Écran inclus / Abajur incluido



908G-G05X 1A-35-RA

908G-G05X 1A-35-RB

908G-G05X 1A-35-RC

E27 (Ø45) [Led / Fluo / Hal] max. 40W

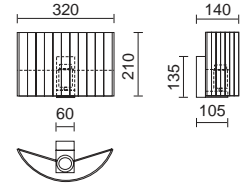

35

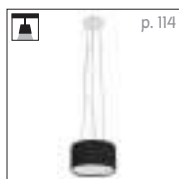

Lámpara recomendada  
Recommended lamp  
Lampe recommandé  
Lámpada recomendada

**LED FILAMENT Ø45**

300°  
15.000hrs

**632H-L0504B-01 7 €**

E27 LED 4W 470lm 3000K



new

# Vorada



Pantalla incluida / Shade included / Écran inclus / Abajur incluido



908A-L0112B-RC

220V  
240V  
AC

- 908A-L0112B-RA  170 €
- 908A-L0112B-RB  170 €
- 908A-L0112B-RC  170 €

LED COB AC 12W 996lm 3000K

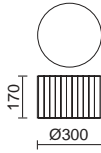

908B-L0112B-RB

110V  
240V  
AC

- 908B-L0125B-RA  399 €
- 908B-L0125B-RB  399 €
- 908B-L0125B-RC  399 €

LED SMD 25W 3540lm 3000K

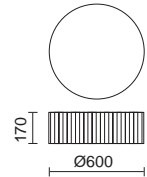

908C-L0112B-RA

110V  
240V  
AC

- 908C-L0129B-RA  499 €
- 908C-L0129B-RB  499 €
- 908C-L0129B-RC  499 €

LED SMD 29W 4000lm 3000K

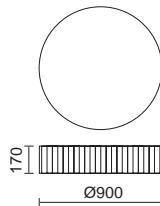



# Kasha



Pantalla incluida / Shade included / Écran inclus / Abajur incluido



**723B-G04X1A-CM ■**

3x E14 [Led / Fluo / Hal] max. 40W

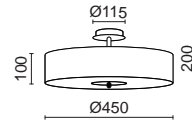

GLASS MAT



Lámparas recomendadas / Recommended lamps  
Lampes recommandées / Lâmpadas recomendadas

LED FILAMENT



pag. 272

# Britta



Pantalla no incluida / Shade not included / Abat-Jour exclu / Abajur não incluido



50

**681A-G05X1A-O2 ■**

E27 [Led / Fluo / Hal] max. 60W

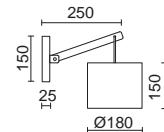

Pantalla disponible / Available shade  
Abat-Jour disponible / Abajur disponível

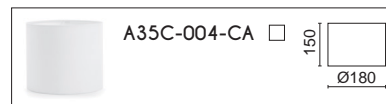

681A-G05X1A-O2 + A35C-004-CA

▲ Otros acabados de pantalla bajo pedido, pag. 283  
Other shade finishes available upon request, pag. 283  
Autres finitions des abat-jours sur demande, pag. 283  
Outros acabamentos para os Abajures sob pedido, pag. 283



Lámparas recomendadas / Recommended lamps  
Lampes recommandées / Lâmpadas recomendadas

LED FILAMENT



pag. 272

# Kai



new

Pantalla incluida / Shade included / Écran inclus / Abajur incluido

856C-G05X1A-43 □

E27 (Ø45) [Led / Fluo / Hal] max. 40W

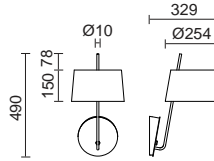

Lámpara recomendada  
Recommended lamp  
Lampe recommandé  
Lámpada recomendada

	LED FILAMENT Ø45
	300°
	15.000hrs
<b>632H-L0504B-01</b>	<b>7 €</b>
E27 LED 4W 470lm 3000K	



# Easy



Pantalla no incluida / Shade not included / Abat-Jour exclu / Abajur não incluído



595A-G05X1A-35 + A32A-004-CA

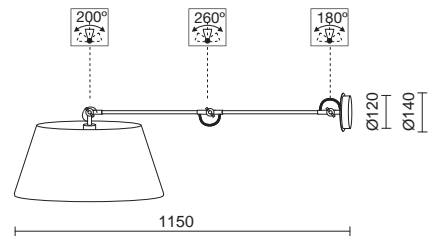

## 595A-G05X1A-35

E27 [Led / Fluo / Hal] max. 60W

Pantallas disponibles / Available shades / Abat-Jours disponibles / Abajures disponíveis

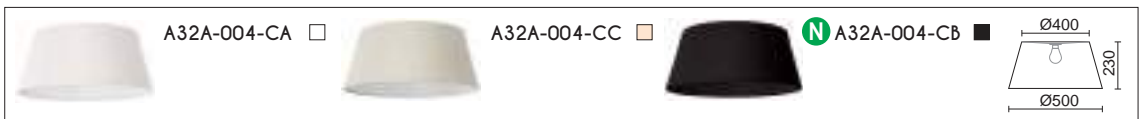

▲ Otros acabados de pantalla bajo pedido, pag. 283 / Other shade finishes available upon request, pag. 283  
Autres finitions des abat-jours sur demande, pag. 283 / Outros acabamentos para os Abajures sob pedido, pag. 283

Lámparas recomendadas  
Recommended lamps  
Lampes recommandées  
Lâmpadas recomendadas

LED FILAMENT



pag. 272



# Firenze



Pantalla no incluida / Shade not included / Abat-Jour exclu / Abajur não incluido



507F-Y05X 1B-35 + A27A-004-CB

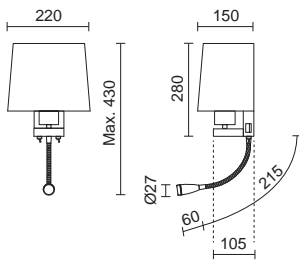

507F-Y05X 1B-35

507F-Y05X 1B-46

E27 [Led / Fluo / Hal] max. 60W  
+ LED SMD 3W 240lm 3000K



507A-Y05X 1B-35

507A-Y05X 1B-46

E27 [Led / Fluo / Hal] max. 60W  
+ LED SMD 3W 240lm 3000K



507E-Y05X 1B-35

E27 [Led / Fluo / Hal] max. 60W  
+ LED SMD 3W 240lm 3000K



Pantallas disponibles / Available shades / Abat-Jours disponibles / Abajures disponiveis

	A26A-004-CA <input type="checkbox"/>		A26A-004-CC <input type="checkbox"/>		A26A-004-CB <input checked="" type="checkbox"/>	
	A27A-004-CA <input type="checkbox"/>		A27A-004-CC <input type="checkbox"/>		A27A-004-CB <input checked="" type="checkbox"/>	

▲ Otros acabados de pantalla bajo pedido, pag. 283 / Other shade finishes available upon request, pag. 283  
Autres finitions des abat-jours sur demande, pag. 283 / Outros acabamentos para os Abajures sob pedido, pag. 283



Lámparas recomendadas / Recommended lamps  
Lampes recommandées / Lâmpadas recomendadas

LED FILAMENT



pag. 272





# Firenze



Pantalla no incluida / Shade not included / Abat-Jour exclu / Abajur não incluido



507X05X1A-35 + A26A-004-CB

**507B-G05X1A-35** ■

E27 [Led / Fluo / Hal] max. 60W

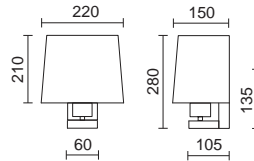

507B-G05X1A-35 + A27A-004-CC

Pantallas disponibles / Available shades / Abat-Jours disponibles / Abajures disponiveis

	<b>A26A-004-CA</b> □		<b>A26A-004-CC</b> ■		<b>A26A-004-CB</b> ■		
	<b>A27A-004-CA</b> □		<b>A27A-004-CC</b> ■		<b>A27A-004-CB</b> ■		

▲ Otros acabados de pantalla bajo pedido, pag. 283 / Other shade finishes available upon request, pag. 283  
 Autres finitions des abat-jours sur demande, pag. 283 / Outros acabamentos para os Abajures sob pedido, pag. 283



Lámparas recomendadas / Recommended lamps  
 Lampes recommandées / Lâmpadas recomendadas

**LED FILAMENT**



pag. 272



# Oval



Pantalla no incluida / Shade not included / Abat-Jour exclu / Abajur não incluído



611C-G05X1A-35 + A28A-004-CB

**611C-G05X1A-35** ■

E27 [Led / Fluó / Hal] max. 60W

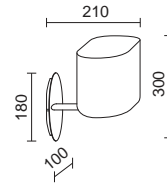

611C-G05X1A-35 + A28A-004-SA



611C-G05X1A-35 + A28A-004-RC

Pantallas disponibles / Available shades / Abat-Jours disponibles / Abajures disponíveis

COTTON	A28A-004-CA <input type="checkbox"/>	A28A-004-CC <input type="checkbox"/>	<b>N</b> A28A-004-CB <input checked="" type="checkbox"/>	
SYNT	<b>N</b> A28A-004-SA <input type="checkbox"/>	<b>N</b> A28A-004-SB <input checked="" type="checkbox"/>		
RIBBON WRAP	<b>N</b> A28A-004-RA <input type="checkbox"/>	<b>N</b> A28A-004-RC <input type="checkbox"/>		

▲ Otros acabados de pantalla bajo pedido, pag. 283 / Other shade finishes available upon request, pag. 283  
Autres finitions des abat-jours sur demande, pag. 283 / Outros acabamentos para os Abajures sob pedido, pag. 283



Lámparas recomendadas / Recommended lamps  
Lampes recommandées / Lâmpadas recomendadas

LED FILAMENT



pag. 272



# Oval



Pantalla no incluida / Shade not included / Abat-Jour exclu / Abajur não incluido

611B-C05X1A-35

E27 [Led / Fluo / Hal] max. 60W

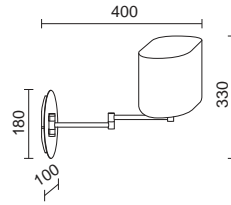

611B-C05X1A-35 + A28A-004-SB



611B-C05X1A-35 + A28A-004-RA

Pantallas disponibles / Available shades / Abat-Jours disponibles / Abajures disponíveis

<input type="checkbox"/>	A28A-004-CA <input type="checkbox"/>	<input type="checkbox"/>	A28A-004-CC <input type="checkbox"/>	<input checked="" type="checkbox"/>	A28A-004-CB <input checked="" type="checkbox"/>
<input checked="" type="checkbox"/>	A28A-004-SA <input type="checkbox"/>	<input checked="" type="checkbox"/>	A28A-004-SB <input checked="" type="checkbox"/>		
<input checked="" type="checkbox"/>	A28A-004-RA <input type="checkbox"/>	<input checked="" type="checkbox"/>	A28A-004-RC <input type="checkbox"/>		

▲ Otros acabados de pantalla bajo pedido, pag. 283 / Other shade finishes available upon request, pag. 283  
 Autres finitions des abat-jours sur demande, pag. 283 / Outros acabamentos para os Abajures sob pedido, pag. 283



Lámparas recomendadas / Recommended lamps  
 Lampes recommandées / Lâmpadas recomendadas

LED FILAMENT



pag. 272



# Oval



Pantalla no incluida / Shade not included / Abat-Jour exclu / Abajur não incluido

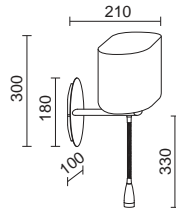

611A-Y05X1A-35

E27 [Led / Fluo / Hal] max. 60W  
+ LED SMD 3W 240lm 3000K



611A-Y05X1A-35 + A28A-004-CB



611A-Y05X1A-35 + A28A-004-SA

Pantallas disponibles / Available shades / Abat-Jours disponibles / Abajures disponíveis

<input type="checkbox"/>	<input type="checkbox"/>	<input checked="" type="checkbox"/>	
<input checked="" type="checkbox"/>	<input type="checkbox"/>	<input checked="" type="checkbox"/>	
<input checked="" type="checkbox"/>	<input type="checkbox"/>	<input checked="" type="checkbox"/>	

▲ Otros acabados de pantalla bajo pedido, pag. 283 / Other shade finishes available upon request, pag. 283  
Autres finitions des abat-jours sur demande, pag. 283 / Outros acabamentos para os Abajures sob pedido, pag. 283



Lámparas recomendadas / Recommended lamps  
Lampes recommandées / Lâmpadas recomendadas

LED FILAMENT



pag. 272





# Gina



Pantalla no incluida / Shade not included / Abat-Jour exclu / Abajur não incluido



600C-G05X1A-35 + A30B-004-CA

**600C-G05X1A-35** ■

E27 [Led / Fluo / Hal] max. 60W

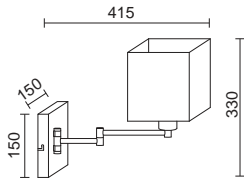
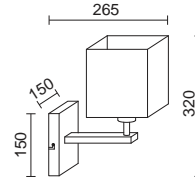

**600B-G05X1A-35** ■

E27 [Led / Fluo / Hal] max. 60W



600B-G05X1A-35 + A30B-004-CC



600A-Y05X1A-35 + A30B-004-CA



**600A-Y05X1A-35** ■

E27 [Led / Fluo / Hal] max. 60W

+ LED SMD 3W 240lm 3000K

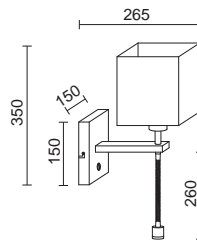

Lámparas recomendadas  
Recommended lamps  
Lampes recommandées  
Lâmpadas recomendadas

**LED FILAMENT**



pag. 272



Pantallas disponibles / Available shades / Abat-Jours disponibles / Abajures disponíveis



▲ Otros acabados de pantalla bajo pedido, pag. 283 / Other shade finishes available upon request, pag. 283  
Autres finitions des abat-jours sur demande, pag. 283 / Outros acabamentos para os Abajures sob pedido, pag. 283

# Gina



Pantalla no incluida / Shade not included / Abat-Jour exclu / Abajur não incluido

**600G-G05X1A-35**

2x E27 [Led / Fluo / Hal] max. 60W

Lámparas recomendadas  
Recommended lamps  
Lampes recommandées  
Lâmpadas recomendadas

LED FILAMENT



pag. 272

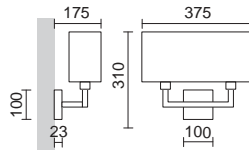

600G-G05X1A-35 + A36D-004-CC

Pantallas disponibles / Available shades / Abat-Jours disponibles / Abajures disponíveis



▲ Otros acabados de pantalla bajo pedido, pag. 283 / Other shade finishes available upon request, pag. 283  
Autres finitions des abat-jours sur demande, pag. 283 / Outros acabamentos para os Abajures sob pedido, pag. 283





Pantalla no incluida / Shade not included / Abat-Jour exclu / Abajur não incluido



717G-G05X1A-02 + A32C-004-HC (x3)

717G-G05X1A-02 ■

717G-G05X1A-03 □

3x E27 [Led / Fluo / Hal] max. 60W

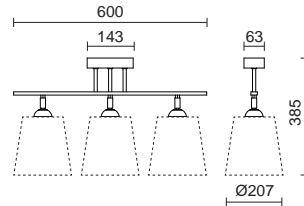
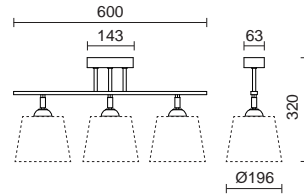

Pantallas disponibles / Available shades / Abat-Jours disponibles / Abajures disponíveis

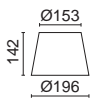

- A32B-004-CA
- A32B-004-CC
- A32B-004-CK
- A32B-004-CJ
- A32B-004-CE
- A32B-004-HC

- A32C-004-CA
- A32C-004-CC
- A32C-004-CK
- A32C-004-CJ
- A32C-004-CE
- A32C-004-HC

Lámparas recomendadas / Recommended lamps  
Lampes recommandées / Lâmpadas recomendadas

LED FILAMENT



pag. 272



▲ Otros acabados de pantalla bajo pedido, pag. 283 / Other shade finishes available upon request, pag. 283  
Autres finitions des abat-jours sur demande, pag. 283 / Outros acabamentos para os Abajures sob pedido, pag. 283



717G-C05X1A-03 + A32C-004-CJ (x3)



717G-C05X1A-02 + A32B-004-HC + A32B-004-CJ + A32B-004-CK



717G-C05X1A-02 + A32B-004-CJ + A32B-004-CE + A32B-004-CJ



717G-C05X1A-02 + A32C-004-CA (x3)



717G-C05X1A-03 + A32B-004-CK (x3)



717G-C05X1A-02 + A32C-004-HC + A32C-004-CJ + A32C-004-CA



Pantalla no incluida / Shade not included / Abat-Jour exclu / Abajur não incluido



717C-G05X1A-02 + A26E-004-HC

717C-G05X1A-02 ■

717C-G05X1A-32 □

E27 [Led / Fluo / Hal] max. 60W

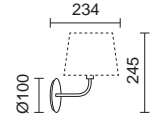

717C-G05X1A-02 + A26E-004-CA



717C-G05X1A-32 + A26E-004-CE



717C-G05X1A-02 + A26E-004-CC



717C-G05X1A-32 + A26E-004-CK

Pantallas disponibles / Available shades  
Abat-Jours disponibles / Abajures disponíveis



- A26E-004-CA
- A26E-004-CC
- A26E-004-CK
- A26E-004-CJ
- A26E-004-CE
- A26E-004-HC

Lámpara recomendada  
Recommended lamp  
Lampe recommandé  
Lâmpada recomendada

**LED FILAMENT Ø45**

**300°**

**15.000hrs**

**632H-L0504B-01** **7 €**

E27 LED 4W 470lm 3000K



▲ Otros acabados de pantalla bajo pedido, pag. 283 / Other shade finishes available upon request, pag. 283  
Autres finitions des abat-jours sur demande, pag. 283 / Outros acabamentos para os Abajures sob pedido, pag. 283

# Bay



Pantalla no incluida / Shade not included / Abat-Jour exclu / Abajur não incluido



708A-Y05X1A-32 + A28E-004-CA



708A-Y05X1A-32 + A28E-004-CC

## 708A-Y05X1A-32 □

E27 [Led / Fluo / Hal] max. 60W  
+  
LED SMD 2W 160lm 3000K

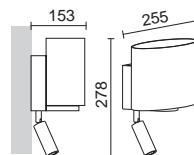

Pantallas disponibles / Available shades  
Abat-Jours disponibles / Abajures disponíveis

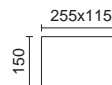

Lámparas recomendadas  
Recommended lamps  
Lampes recommandées  
Lâmpadas recomendadas

### LED FILAMENT



pag. 272

▲ Otros acabados de pantalla bajo pedido, pag. 283 / Other shade finishes available upon request, pag. 283  
Autres finitions des abat-jours sur demande, pag. 283 / Outros acabamentos para os Abajures sob pedido, pag. 283

# Nuno



Pantalla no incluida / Shade not included / Abat-Jour exclu / Abajur não incluido



841A-Y05X1A-35 + A30C-004-CA

Lámparas recomendadas  
Recommended lamps  
Lampes recommandées  
Lâmpadas recomendadas

LED FILAMENT



pag. 272



841A-Y05X1A-35

E27 [Led / Fluo / Hal] max. 60W

+  
LED SMD 3W 240lm 3000K

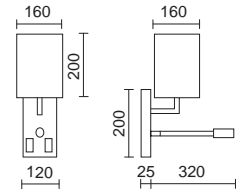

Pantallas disponibles / Available shades / Abat-Jours disponibles / Abajures disponíveis

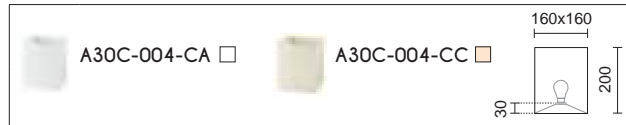

▲ Otros acabados de pantalla bajo pedido, pag. 283 / Other shade finishes available upon request, pag. 283  
Autres finitions des abat-jours sur demande, pag. 283 / Outros acabamentos para os Abajures sob pedido, pag. 283





# Monnet



Pantalla no incluida / Shade not included / Abat-Jour exclu / Abajur não incluído

## 709A-Y05X1A-35

E27 [Led / Fluó / Hal] max. 60W  
+  
LED SMD 2W 160lm 3000K



709A-Y05X1A-35 + A36E-004-CC

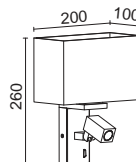

709A-Y05X1A-35 + A36E-004-CA

Pantallas disponibles / Available shades / Abat-Jours disponibles / Abajures disponíveis



▲ Otros acabados de pantalla bajo pedido, pag. 283 / Other shade finishes available upon request, pag. 283  
Autres finitions des abat-jours sur demande, pag. 283 / Outros acabamentos para os Abajures sob pedido, pag. 283

Lámparas recomendadas  
Recommended lamps  
Lampes recommandées  
Lâmpadas recomendadas

LED FILAMENT



pag. 272

# Verona



Pantalla no incluida / Shade not included / Abat-Jour exclu / Abajur não incluido



510A-YO4X1B-35

E14 [Led / Fluo / Hal] max. 40W  
+  
LED SMD 3W 240lm 3000K



510A-YO4X1B-35 + A29A-004-CC

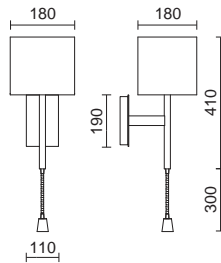

510A-YO4X1B-35 + A30A-004-CA

Pantallas disponibles / Available shades  
Abat-Jours disponibles / Abajures disponibles

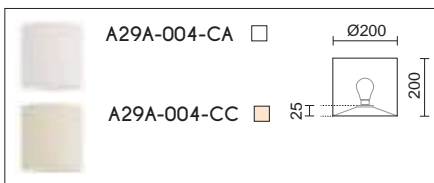

Pantallas disponibles / Available shades  
Abat-Jours disponibles / Abajures disponibles

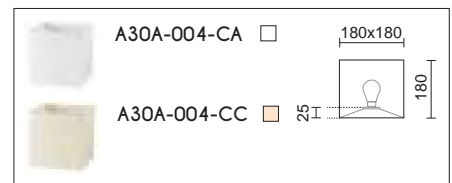

Lámparas recomendadas  
Recommended lamps  
Lampes recommandées  
Lâmpadas recomendadas

LED FILAMENT



pag. 272

▲ Otros acabados de pantalla bajo pedido, pag. 283 / Other shade finishes available upon request, pag. 283  
Autres finitions des abat-jours sur demande, pag. 283 / Outros acabamentos para os Abajures sob pedido, pag. 283

# Bearn



Pantalla no incluida / Shade not included / Abat-Jour exclu / Abajur não incluido



516A-Y04X1B-32

E14 [Led / Fluo / Hal] max. 40W

+ LED SMD 3W 240lm 3000K

Pantalla disponible / Available shade  
Abat-Jour disponible / Abajure disponível

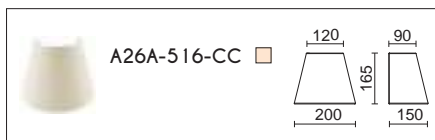

▲ Otros acabados de pantalla bajo pedido, pag. 283  
Other shade finishes available upon request, pag. 283  
Autres finitions des abat-jours sur demande, pag. 283  
Outros acabamentos para os Abajures sob pedido, pag. 283

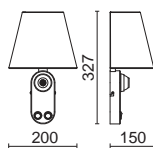

Lámparas recomendadas  
Recommended lamps  
Lampes recommandées  
Lâmpadas recomendadas

LED FILAMENT



pag. 272

# Eda



Pantalla no incluida / Shade not included / Abat-Jour exclu / Abajur não incluido



596A-Y05X1A-32 + A26D-004-CA



596A-Y05X1A-32 + A26D-004-CC

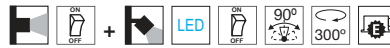
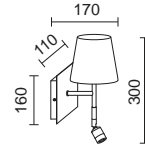

## 596A-Y05X1A-32 □

E27 [Led / Fluo / Hal] max. 60W  
+  
LED SMD 3W 240lm 3000K

Pantallas disponibles / Available shades  
Abat-Jours disponibles / Abajures disponíveis

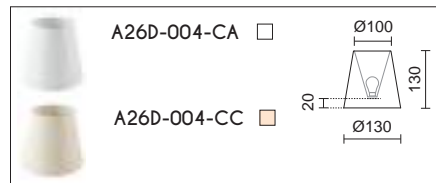

Lámparas recomendadas / Recommended lamps  
Lampes recommandées / Lâmpadas recomendadas

### LED FILAMENT



pag. 272

▲ Otros acabados de pantalla bajo pedido, pag. 283 / Other shade finishes available upon request, pag. 283  
Autres finitions des abat-jours sur demande, pag. 283 / Outros acabamentos para os Abajures sob pedido, pag. 283



# Toscana

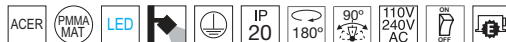

842A-L0103B-01 □

842A-L0103B-35 ●

LED SMD 3W 200lm 3000K

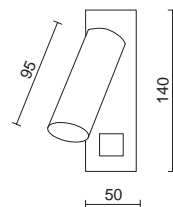

# Dirk

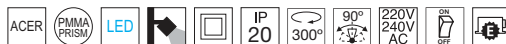

704A-L0103B-01 □

LED SMD 3W 200lm 3000K

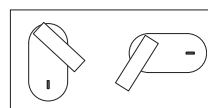
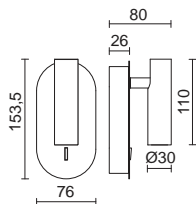

Doble posición.  
Double position.  
Double position.  
Posição dupla.

# Spot



**616A-LO103A-40** ■

LED SMD 3W 240lm 3000K

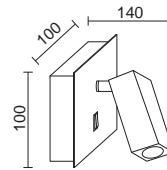

# Lector



**705A-LO103B-01** □

**705A-LO103B-02** ■

LED SMD 3W 200lm 3000K



SILICON

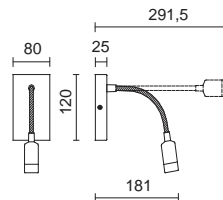

# Dorés



700A-L0106B-32 □

LED SMD 3W 200lm 3000K  
+  
LED SMD 3W 200lm 3000K

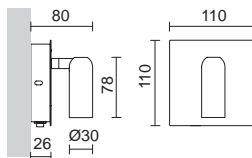
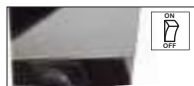

# Baltic



32



**727A-Y05X1B-01** □

E27 [Led / Fluo / Hal] max. 60W

+ LED SMD 3W 240lm 3000K

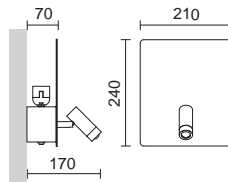

32



**727C-Y05X1B-01** □

E27 [Led / Fluo / Hal] max. 60W

+ LED SMD 3W 240lm 3000K



**727B-G05X1A-01** □

E27 [Led / Fluo / Hal] max. 60W

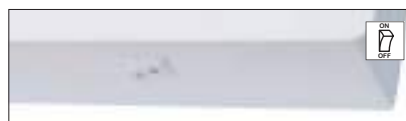
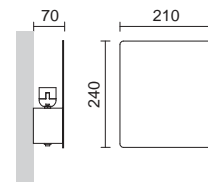





new

# Montecarlo



907B-G05X 1A-02-CB ■

E27 (Ø45) [Led / Fluo / Hal] max. 60W

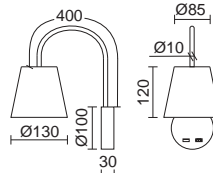

Lámpara recomendada  
Recommended lamp  
Lampe recommandée  
Lámpada recomendada

**LED FILAMENT Ø45**

300°

15.000hrs

**632H-L0504B-01**

E27 LED 4W 470lm 3000K



# Elfi

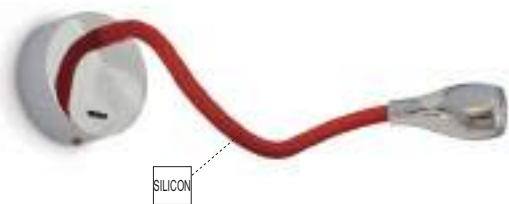

710A-LO103A-02 ■  
710A-LO103A-07 ■  
LED SMD 2W 160lm 3000K

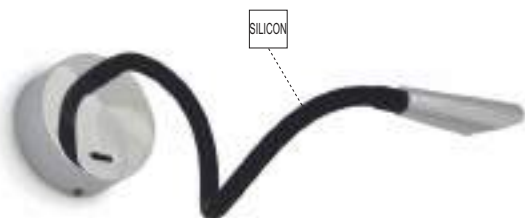
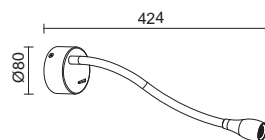

710B-LO103A-02 ■  
710B-LO103A-07 ■  
LED SMD 2W 160lm 3000K

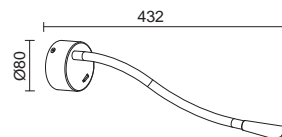

# Leiden

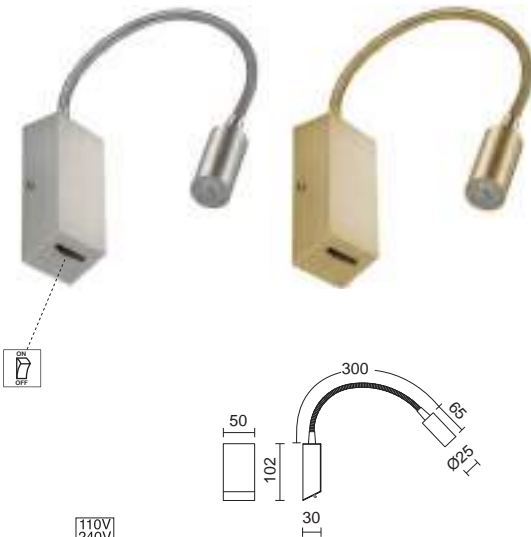

110V  
240V  
AC

517B-LO103B-35

517B-LO103B-46

LED SMD 3W 240lm 3000K

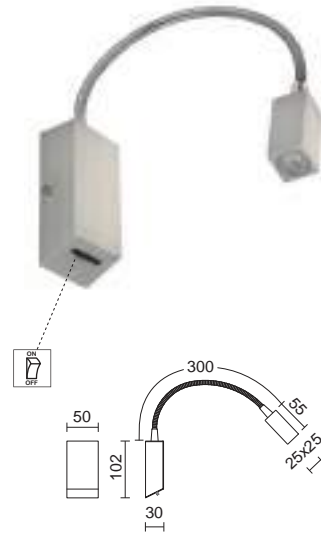

110V  
240V  
AC

517D-LO103B-35

LED SMD 3W 240lm 3000K

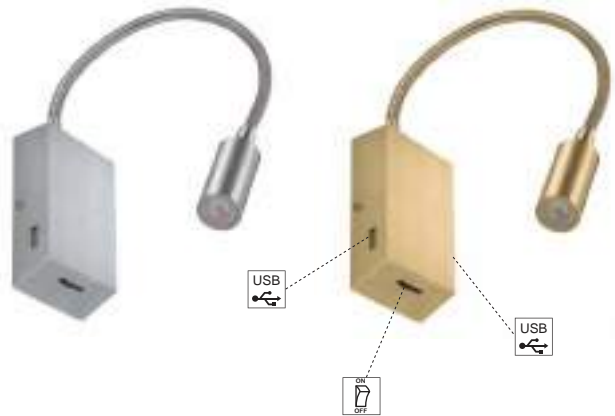

USB x2 220V  
240V  
AC

517E-LO103B-35

517E-LO103B-46

LED SMD 3W 240lm 3000K

# Olvas

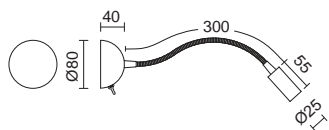
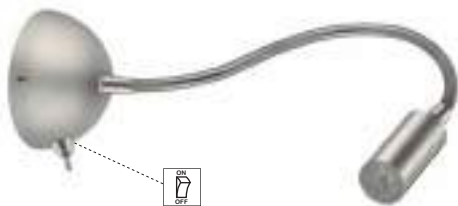

**518B-L0103A-35** ■

LED SMD 3W 240lm 3000K

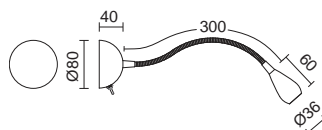

**518A-L0103A-35** ■

LED SMD 3W 240lm 3000K

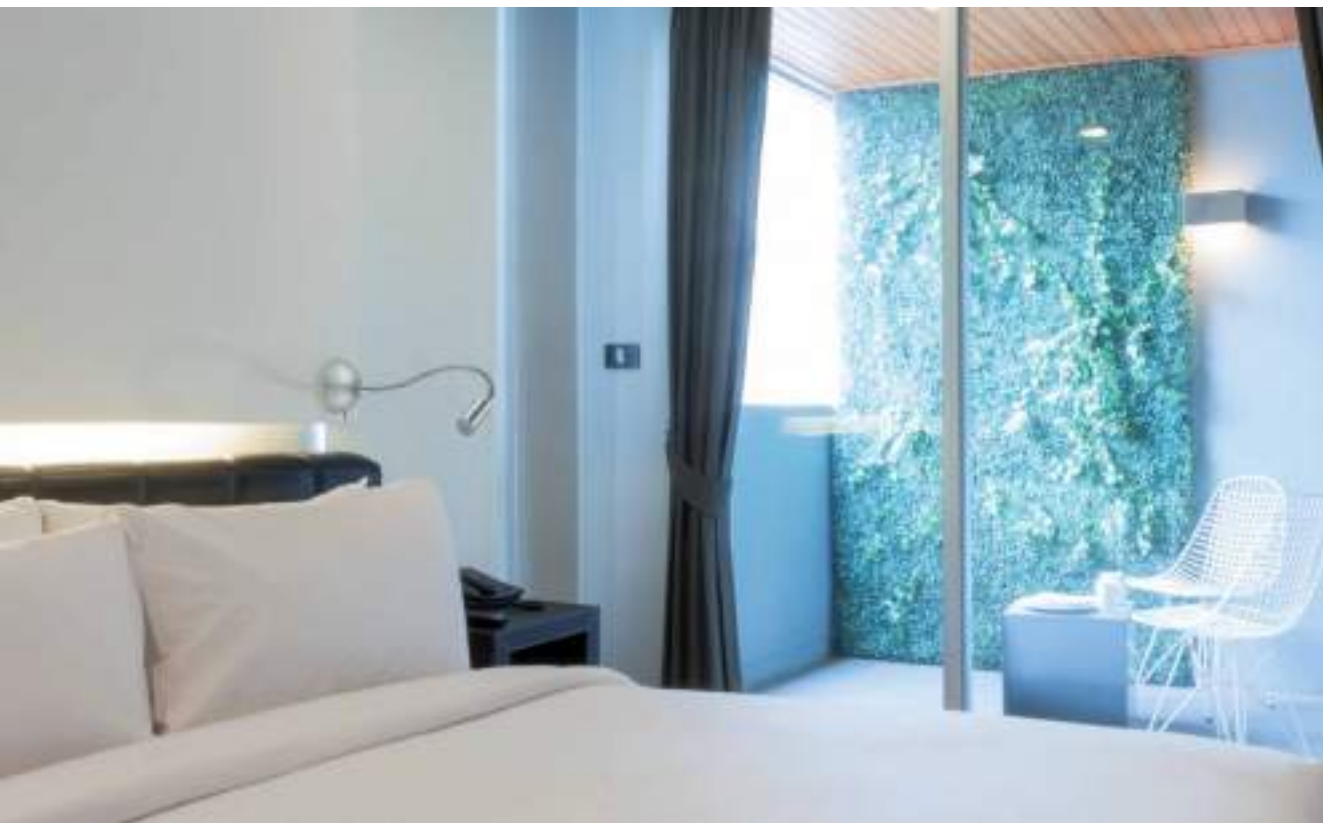

# Julia



603A-L0105A-32 □

LED COB 5W 420lm 3000K

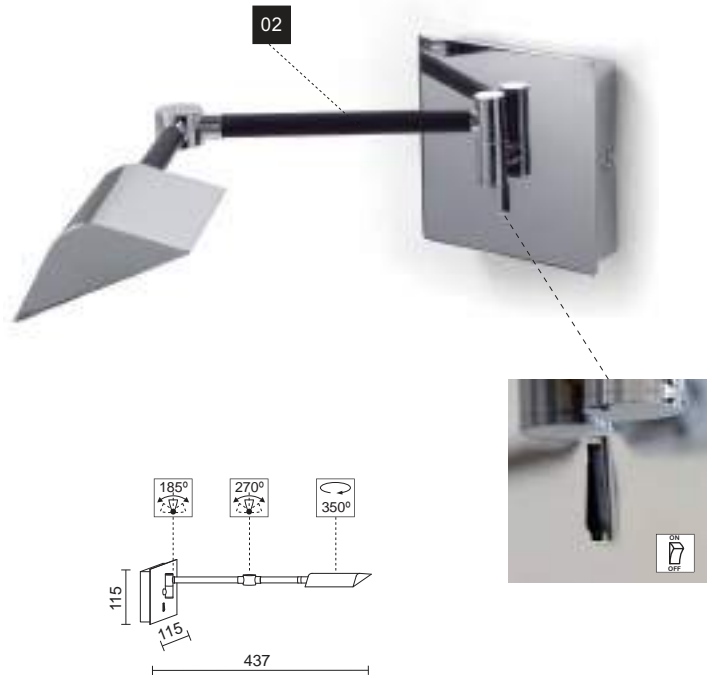

# Book



588A-L0104A-02 ■

LED SMD 4W 280lm 3000K

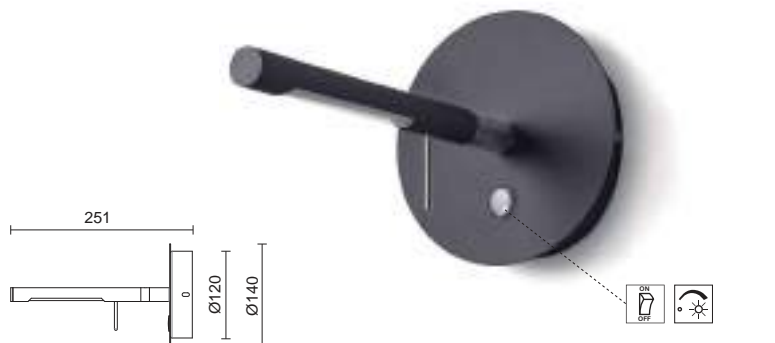



# Lore



**624A-L0103A-35** ■

LED SMD 3W 240lm 3000K

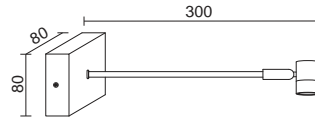

# Tabel



**625A-L0106A-35** ■

LED SMD 6W 500lm 3000K

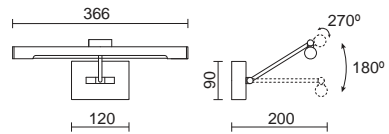

**625B-L0112A-35** ■

LED SMD 12W 1000lm 3000K







# Cloé



680A-G04X1A-13 ■

E14 [Led / Fluo / Hal] max. 40W

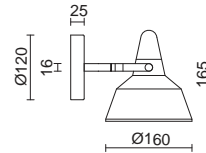

Lámparas recomendadas  
Recommended lamps  
Lampes recommandées  
Lâmpadas recomendadas

LED FILAMENT



pag. 272

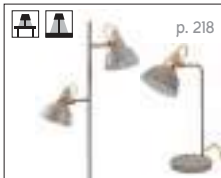

# Valan



846B-G05X1A-01 □

E27 [Led / Fluo / Hal] max. 60W

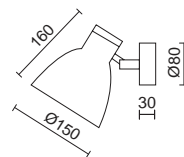

Lámparas recomendadas  
Recommended lamps  
Lampes recommandées  
Lâmpadas recomendadas

LED FILAMENT



pag. 272





# Diden

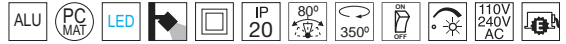

592A-L0105A-03 ■

LED COB 5W 330lm 3000K

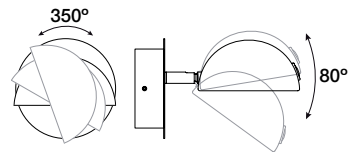
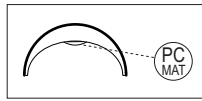
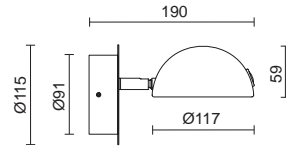

# Elke



714A-G21X1A-32 □

GU10 [Led / Hal] max. 50W

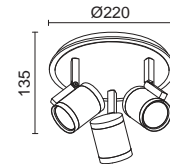
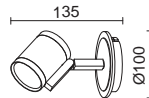

714B-G21X1A-32 □

3x GU10 [Led / Hal] max. 50W

Lámparas recomendadas  
Recommended lamps  
Lampes recommandées  
Lâmpadas recomendadas

LED PRO



pag. 273



# Denar

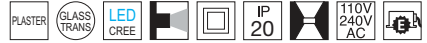

711A-L0106A-01 □

LED SMD 2x 2W 2x 160lm 3000K

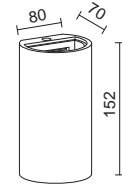

# Nucir



713A-L0106A-01 □

LED SMD 2x 2W 2x 160lm 3000K

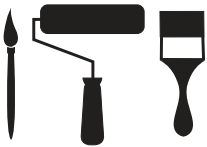
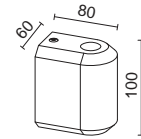

Se recomienda el uso de papel de lija en la superficie antes de aplicar pintura para pared.

It is recommended to sand with fine grain sandpaper the surface of the luminaire before painting it with the wall paint.

Avant d'appliquer la peinture murale, poncer la surface du luminaire avec du papier de verre à grains fins.

Recomenda-se o uso de lixa na superfície antes da pintura com tinta de parede.

# Tania



new



906A-G21X1A-01

906A-G21X1A-02

906A-G21X1A-37

2x GU10 [Led / Hal] max. 50W

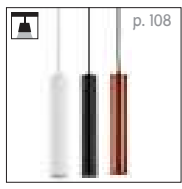
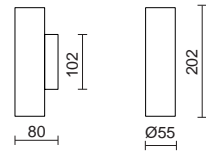

Lámparas recomendadas  
Recommended lamps  
Lampes recommandées  
Lâmpadas recomendadas

LED PRO



pag. 273

# Brick



**412A-L0103B-40** ■

LED SMD 3W 165lm 3000K

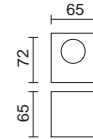

**412B-L01E2B-40** ■

LED SMD 2x 3W 2x 165lm 3000K

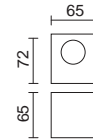

# Brick



**412B-L01F1B-01** □

**412B-L01F1B-40** ■

LED SMD 2x 5W 2x 325lm 3000K

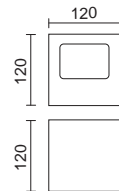





# Shadow



4 19B-LO1D1B-40 

2x LED SMD 3W 195lm 3000K

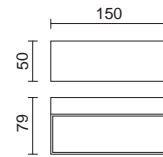

# Iona

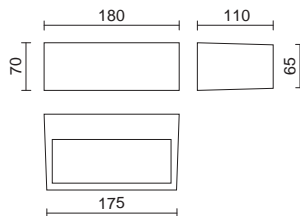

634A-LO113B-01

634A-LO113B-03

LED SMD 13W 1200lm 3000K



634A-H35X1A-01

634A-H35X1A-03

R7s (74,9 mm) QT-DE 60W max.



634B-LO113B-01

634B-LO113B-03

LED SMD 13W 1200lm 3000K



# Rett



504C-L0105A-01

504C-L0105A-40

LED SMD 5W 450lm 3000K

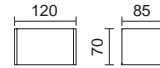

504A-L0108A-01

504A-L0108A-40

LED SMD 8W 790lm 3000K

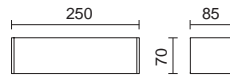

504B-L0124A-01

504B-L0124A-40

LED SMD 24W 2270lm 3000K

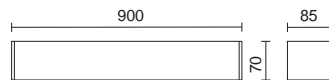



# Deneb



695A-L0112A-01

695A-L0112A-32

LED SMD 12W 1200lm 3000K

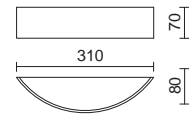

# Cluny



691A-L0116A-40

LED SMD 16W 1600lm 3000K

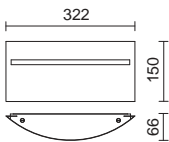



# Remy



498A-L0105A-01 □

LED COB 5W 405lm 3000K

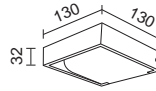



# Sheibe



613A-L0105A-01 □  
LED COB 5W 450lm 3000K

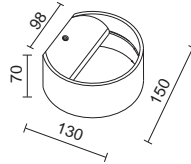

# Iv



497A-L0105A-01 □  
497A-L0105A-39 ■  
LED COB 5W 437lm 3000K

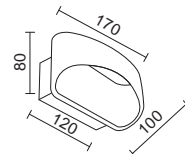

# Aliya

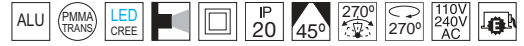

584A-L0105A-01 □

LED COB 5W 450lm 3000K

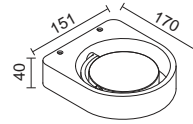

# Ribbon



697A-L0106B-01 □  
LED SMD 6W 300lm 3000K

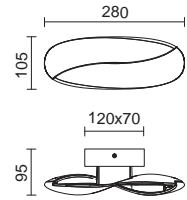

# Pyramid

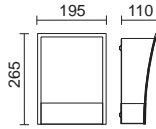

612A-G05X1A-32 □

2x E27 [Led / Fluo / Hal] max. 60W

Lámparas recomendadas / Recommended lamps  
Lampes recommandées / Lâmpadas recomendadas

LED FILAMENT



pag. 272



# Espiga



693A-L01 I2A-35 ■

LED SMD 12W 1200lm 3000K

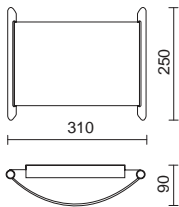

# Vollmond



626A-G05X1A-32 □

E27 [Led / Fluo / Hal] max. 60W

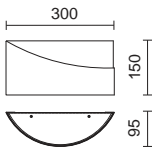

Lámparas recomendadas / Recommended lamps  
Lampes recommandées / Lâmpadas recomendadas

LED FILAMENT



pag. 272

# Circus



589A-G05X1A-35

2x E27 [Led / Fluo / Hal] max. 60W

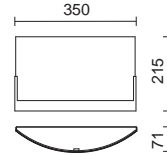

Lámparas recomendadas / Recommended lamps  
Lampes recommandées / Lâmpadas recomendadas

**LED FILAMENT**



pag. 272



# Menkar



694A-L01 12A-35 ■

LED SMD 12W 1200lm 3000K

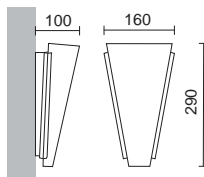

# Finn



**690A-L0112A-35** ■

LED SMD 12W 1200lm 3000K

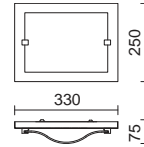

# Aurora



**689A-L0124A-40** ■

LED SMD 24W 2400lm 3000K

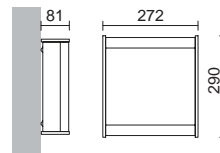



# Toliman



692A-L0106A-01 □

692A-L0106A-32 □

LED SMD 6W 600lm 3000K

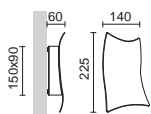

# Fred

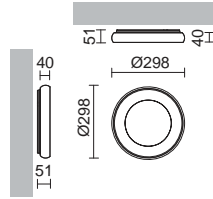

7 15A-L0125A-01 □

7 15A-L0125A-02 ■

7 15A-L0125A-03 ▣

LED SMD 25W 1850lm 3000K

Accesorio para tapar la superficie  
 Accessory to cover surface  
 Accessoire pour couvrir surface  
 Acessório para tapar superficie

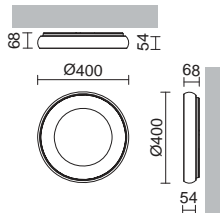

7 15B-L3135A-01 □

7 15B-L3135A-02 ■

7 15B-L3135A-03 ▣

LED SMD 35W 2940lm 3000K

Accesorio para tapar la superficie  
 Accessory to cover surface  
 Accessoire pour couvrir surface  
 Acessório para tapar superficie





# Cubi



426B-G21X1A-01

426B-G21X1A-02

GU10 [Led / Hal] max. 50W

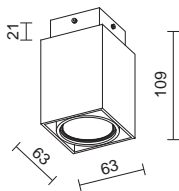

Lámparas recomendadas  
Recommended lamps  
Lampes recommandées  
Lâmpadas recomendadas

LED PRO



pag. 273



# Clear



590A-F0322B-32 □

2GX13 T5c 22W

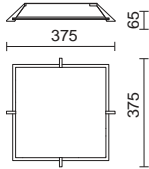

# Siker

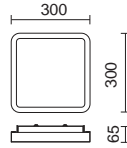

**505A-LO124A-35** ●

LED SMD 24W 1800lm 3000K\*

**505A-F13B7B-35** ●

2x G24q2 TC-DE 18W



**505B-LO148B-35** ●

LED SMD 24W 2800lm 3000K\*

**505B-F02C5B-35** ●

2x G24q2 TC-L 55W

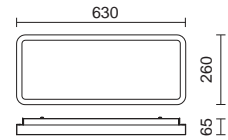

**505C-F02F8B-35** ●

3x G24q2 TC-L 36W

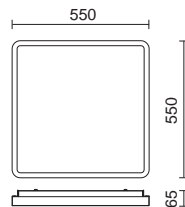

- \* Disponible en 4000K
- \* Available in 4000K
- \* Disponible en 4000K
- \* Disponivel com 4000K

# Lari



503A-F0340B-01

503A-F0340B-32

2GX13 T5 40W

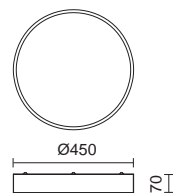

503B-L0150B-01

503B-L0150B-32

LED SMD 50W 3960lm 3000K

503B-F03G3B-32

2GX13 T5 22W + 40W

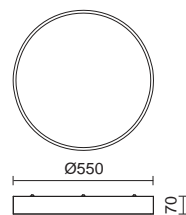

# Borgo

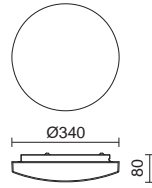

501A-G05X1A-28 □

3x E27 [Led / Fluo / Hal] max. 60W

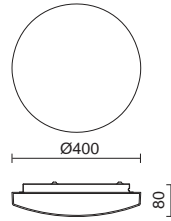

501B-G05X1A-28 □

4x E27 [Led / Fluo / Hal] max. 60W

Lámparas recomendadas / Recommended lamps  
Lampes recommandées / Lámpadas recomendadas

LED FILAMENT



pag. 272





# Carpi



500A-G05X1A-32 □

2x E27 [Led / Fluo] max. 23W

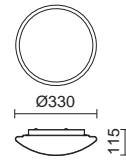

Lámparas recomendadas / Recommended lamps  
Lampes recommandées / Lâmpadas recomendadas

LED FILAMENT



pag. 272





LOBBY LOUNGE



Suspensión  
Pendant  
Suspension  
Suspensão

new

# Diagonal



Pantalla no incluida / Shade not included / Abat-Jour exclu / Abajur não incluido



By Nacho Timón



855D-C05X1A-01 + A37A-004-SA



855D-C05X1A-02 + A37A-004-SB



855D-C05X1A-37 + A37A-004-SM

855D-C05X1A-01

855D-C05X1A-02

855D-C05X1A-37

3x E27 [Led] max. 13W

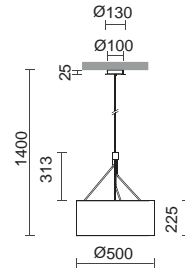

855D-C05X1A-02 + A37A-004-SM

855D-C05X1A-02 + A37A-004-SA

Pantallas disponibles / Available shades  
Abat-Jours disponibles / Abajures disponíveis

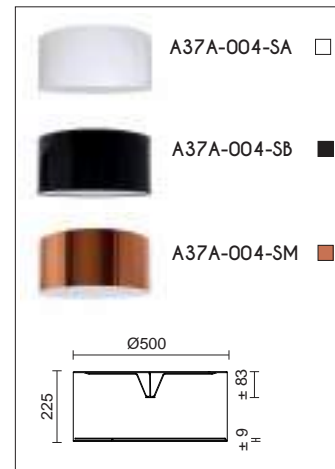

Lámparas recomendadas  
Recommended lamps  
Lampes recommandées  
Lâmpadas recomendadas

LED FILAMENT



pag. 272

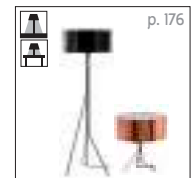



new

# Tania



- 906B-G21X1A-01
  - 906B-G21X1A-02
  - 906B-G21X1A-37
- GU10 [Led / Hal] max. 50W

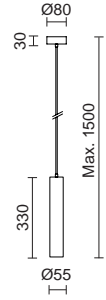

Lámparas recomendadas  
Recommended lamps  
Lampes recommandées  
Lâmpadas recomendadas

LED PRO



pag. 273

- 906C-G21X1A-01
  - 906C-G21X1A-02
  - 906C-G21X1A-37
- GU10 [Led / Hal] max. 50W

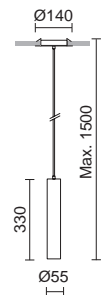



# Selma



Pantalla incluida / Shade included / Écran inclus / Abajur incluido

840B-G05X 1A-55 ■

840B-G05X 1A-56 ■

E27 [Led / Fluo / Hal] max. 40W

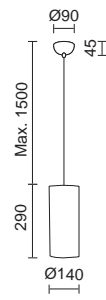

Lámparas recomendadas  
Recommended lamps  
Lampes recommandées  
Lâmpadas recomendadas

LED FILAMENT



pag. 272







# Selma



Pantalla incluida / Shade included / Écran inclus / Abajur incluido

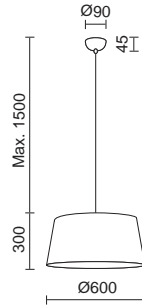

840A-G05X1A-55

840A-G05X1A-56

E27 [Led / Fluó / Hal] max. 40W



Lámparas recomendadas / Recommended lamps  
Lampes recommandées / Lâmpadas recomendadas

## LED FILAMENT



pag. 272



new

# Vorada



Pantalla incluida / Shade included / Écran inclus / Abajur incluido



220V  
240V  
AC

908D-LO112B-RA

908D-LO112B-RB

908D-LO112B-RC

LED COB AC 12W 996lm 3000K

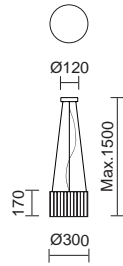

RB



RA

110V  
240V  
AC

908E-LO125B-RA

908E-LO125B-RB

908E-LO125B-RC

LED SMD 25W 3540lm 3000K

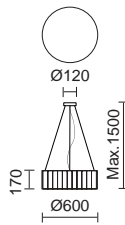

110V  
240V  
AC

908F-LO129B-RA

908F-LO129B-RB

908F-LO129B-RC

LED SMD 29W 4000lm 3000K

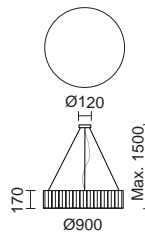

RC

PC  
OPAL





new

## Cora



Pantalla incluida / Shade included / Écran inclus / Abajur incluido

859A-G05X1A-35-RA

859A-G05X1A-35-RB

859A-G05X1A-35-RC

3x E27 [Led / Fluo / Hal] max. 60W

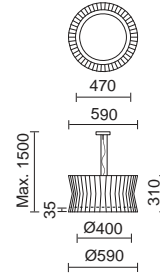

Lámparas recomendadas / Recommended lamps  
Lampes recommandées / Lâmpadas recomendadas

LED FILAMENT



pag. 272



# Oval



Pantalla no incluida / Shade not included / Abat-Jour exclu / Abajur não incluído

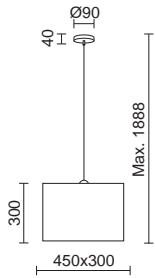

**N** 716A-G05X1A-09

**N** 716A-G05X1A-29

E27 [Led / Fluo / Hal] max. 60W

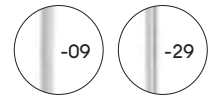

716A-G05X1A-29 + A28B-004-SB



716A-G05X1A-29 + A28B-004-CA



716A-G05X1A-09 + A28B-004-RC

Pantallas disponibles / Available shades / Abat-Jours disponibles / Abajures disponíveis

	<b>A28B-004-CA</b> <input type="checkbox"/>	<b>N 28B-004-CC</b> <input type="checkbox"/>	<b>N A28B-004-CB</b> <input type="checkbox"/>
	<b>N A28B-004-SA</b> <input type="checkbox"/>	<b>N 28B-004-SB</b> <input type="checkbox"/>	
	<b>N A28B-004-RA</b> <input type="checkbox"/>	<b>N 28B-004-RC</b> <input type="checkbox"/>	

▲ Otros acabados de pantalla bajo pedido, pag. 283 / Other shade finishes available upon request, pag. 283 / Autres finitions des abat-jours sur demande, pag. 283 / Outros acabamentos para os Abajures sob pedido, pag. 283



Lámparas recomendadas / Recommended lamps  
Lampes recommandées / Lâmpadas recomendadas

LED FILAMENT



pag. 272





# Firenze



Pantalla no incluida / Shade not included / Abat-Jour exclu / Abajur não incluído



716A-G05X1A-09 + A32A-004-CC

716A-G05X1A-29 + A32A-004-CA

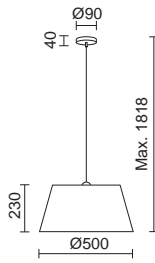

**N** 716A-G05X1A-09

**N** 716A-G05X1A-29

E27 [Led / Fluo / Hal] max. 60W

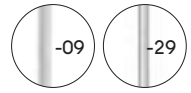

Pantallas disponibles / Available shades / Abat-Jours disponibles / Abajures disponíveis

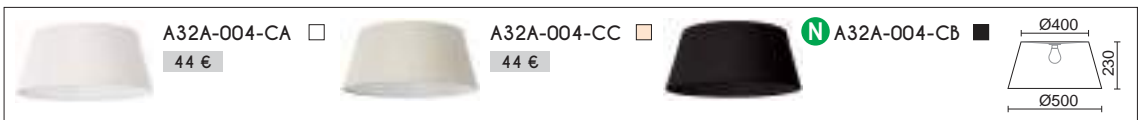

▲ Otros acabados de pantalla bajo pedido, pag. 283 / Other shade finishes available upon request, pag. 283  
Autres finitions des abat-jours sur demande, pag. 283 / Outros acabamentos para os Abajures sob pedido, pag. 283



# Kasha



Pantalla incluida / Shade included / Écran inclus / Abajur incluido



723A-G04X1A-CM ■

3x E14 [Led / Fluó / Hal] 3x max. 40W

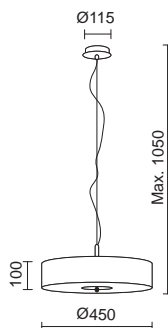

Lámparas recomendadas / Recommended lamps  
Lampes recommandées / Lâmpadas recomendadas

LED FILAMENT



pag. 272





Pantalla no incluida / Shade not included / Abat-Jour exclu / Abajur não incluído

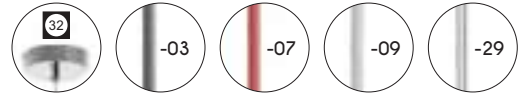

7 16A-G05X 1A-03

7 16A-G05X 1A-07

7 16A-G05X 1A-09

7 16A-G05X 1A-29

E27 [Led / Fluo / Hal] max. 60W



716A-G05X1A-29 + A32D-004-CK



716A-G05X1A-07 + A32C-004-HC

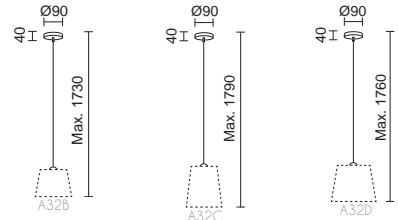

Pantallas disponibles / Available shades / Abat-Jours disponibles / Abajures disponíveis

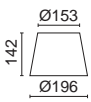

- A32B-004-CA
- A32B-004-CC
- A32B-004-CK
- A32B-004-CJ
- A32B-004-CE
- A32B-004-HC



- A32C-004-CA
- A32C-004-CC
- A32C-004-CK
- A32C-004-CJ
- A32C-004-CE
- A32C-004-HC



- A32D-004-CA
- A32D-004-CC
- A32D-004-CK
- A32D-004-CJ
- A32D-004-CE
- A32D-004-HC

▲ Otros acabados de pantalla bajo pedido, pag. 283 / Other shade finishes available upon request, pag. 283  
Autres finitions des abat-jours sur demande, pag. 283 / Outros acabamentos para os Abajures sob pedido, pag. 283

Lámparas recomendadas  
Recommended lamps  
Lampes recommandées  
Lâmpadas recomendadas

LED FILAMENT



pag. 272



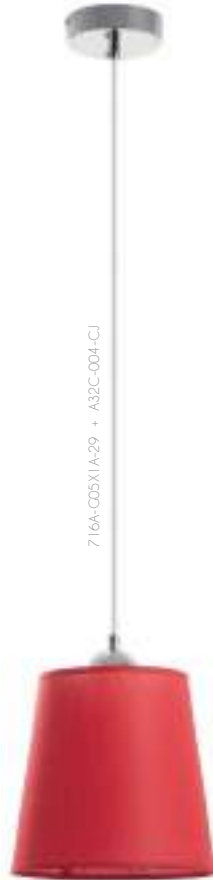



Pantalla no incluida / Shade not included / Abat-Jour exclu / Abajur não incluído

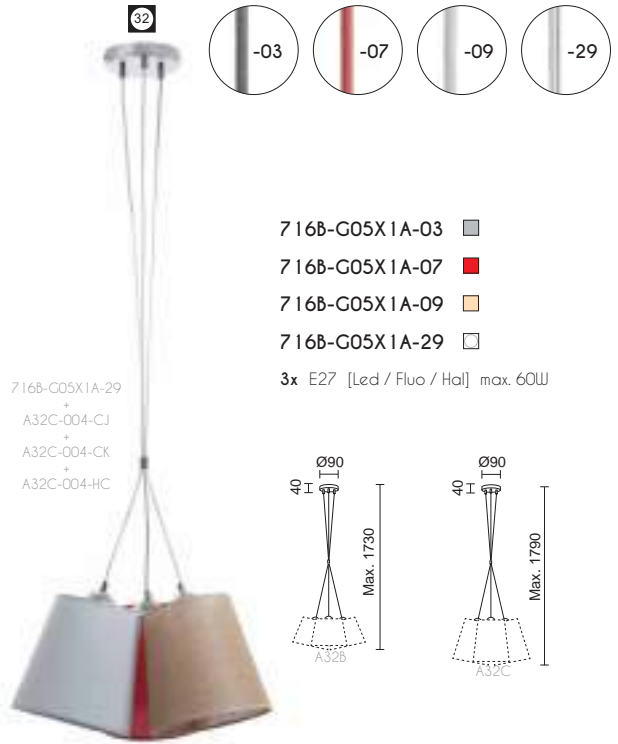

716B-G05X1A-29  
+  
A32C-004-CJ  
+  
A32C-004-CK  
+  
A32C-004-HC

716B-G05X1A-07  
+  
A32C-004-CJ  
+  
A32C-004-CK  
+  
A32C-004-CA

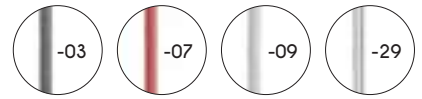

- 716B-G05X1A-03
- 716B-G05X1A-07
- 716B-G05X1A-09
- 716B-G05X1A-29

3x E27 [Led / Fluo / Hal] max. 60W

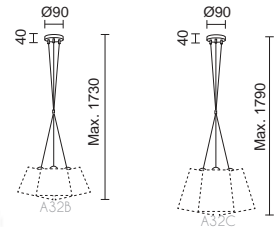

Abajures / Abajures disponíveis



- |   |   |
|---|---|
| A32B-004-CA <input type="checkbox"/>            | A32C-004-CA <input type="checkbox"/>            |
| A32B-004-CC <input type="checkbox"/>            | A32C-004-CC <input type="checkbox"/>            |
| A32B-004-CK <input type="checkbox"/>            | A32C-004-CK <input type="checkbox"/>            |
| A32B-004-CJ <input checked="" type="checkbox"/> | A32C-004-CJ <input checked="" type="checkbox"/> |
| A32B-004-CE <input type="checkbox"/>            | A32C-004-CE <input type="checkbox"/>            |
| A32B-004-HC <input type="checkbox"/>            | A32C-004-HC <input type="checkbox"/>            |

▲ Otros acabados de pantalla bajo pedido, pag. 283 / Other shade finishes available upon request, pag. 283  
Autres finitions des abat-jours sur demande, pag. 283 / Outros acabamentos para os Abajures sob pedido, pag. 283

Lámparas recomendadas  
Recommended lamps  
Lampes recommandées  
Lâmpadas recomendadas

LED FILAMENT



pag. 272



p. 50



p. 52



# Vimet



724A-G05X1A-53 ■  
 724A-G05X1A-54 ■  
 E27 [Led / Fluo / Hal] max. 60W

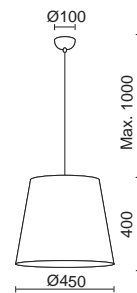

Lámparas recomendadas / Recommended lamps  
 Lampes recommandées / Lâmpadas recomendadas

LED FILAMENT



pag. 272





# Cuska



720A-G05X1A-50 ■

E27 [Led / Fluo / Hal] max. 60W

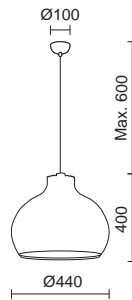
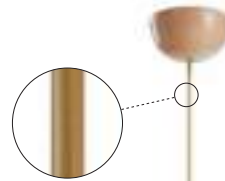

720B-G05X1A-50 ■

E27 [Led / Fluo / Hal] max. 60W

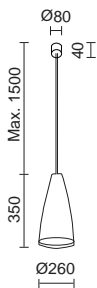

Lámparas recomendadas / Recommended lamps  
Lampes recommandées / Lâmpadas recomendadas

LED FILAMENT



pag. 272





# Tess

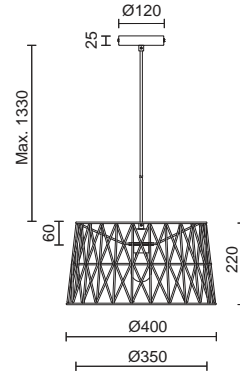

837C-G05X1A-01 □

E27 [Léd / Fluo / Hal] max. 60W

Lámparas recomendadas / Recommended lamps  
Lampes recommandées / Lâmpadas recomendadas

LED FILAMENT



pag. 272





# Baguet



**685B-G05X1A-02 ■**

E27 [Led / Fluo / Hal] max. 60W

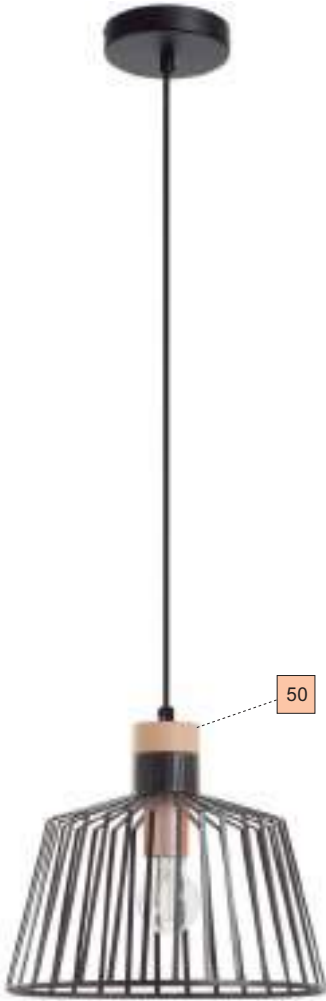

**685A-G05X1A-02 ■**

E27 [Led / Fluo / Hal] max. 60W

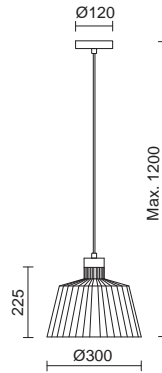
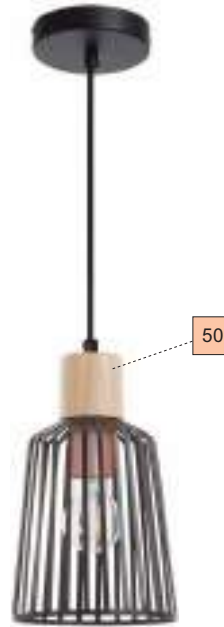

Lámparas recomendadas / Recommended lamps  
Lampes recommandées / Lâmpadas recomendadas

LED FILAMENT



pag. 272



# Elga



684A-G05X1A-02 ■

E27 [Led / Fluo / Hal] max. 60W

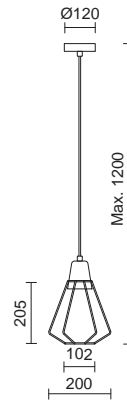

Lámparas recomendadas / Recommended lamps  
Lampes recommandées / Lâmpadas recomendadas

LED FILAMENT



pag. 272





# Flavia



686A-C05X1A-44 □

E27 [Led / Fluo / Hal] max. 60W

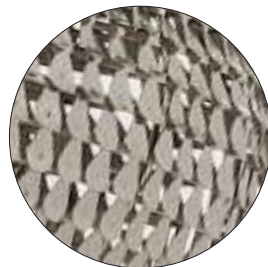
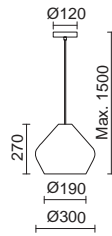

Lámparas recomendadas / Recommended lamps  
Lampes recommandées / Lâmpadas recomendadas

LED FILAMENT



pag. 272



# Sira



687A-G05X1A-01

687A-G05X1A-37

E27 [Led / Fluo / Hal] max. 60W

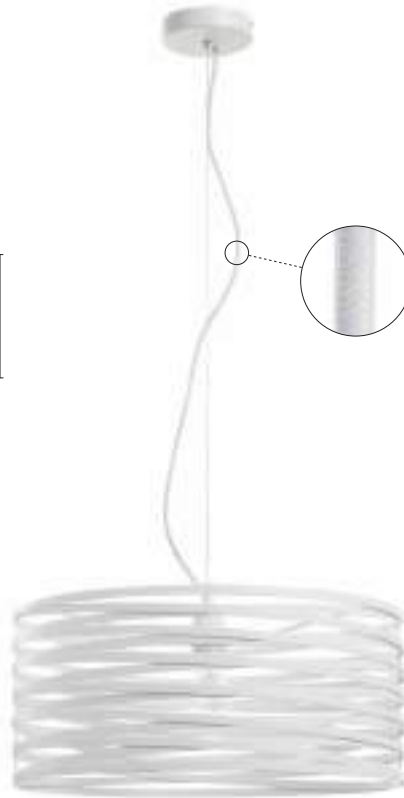
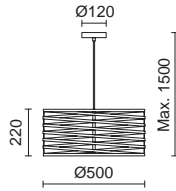

Lámparas recomendadas / Recommended lamps  
Lampes recommandées / Lâmpadas recomendadas

LED FILAMENT



pag. 272



# Beton

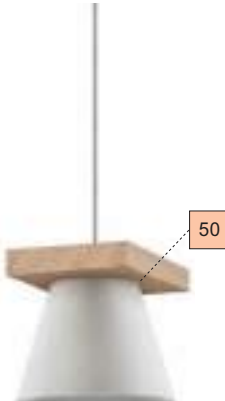

**683A-G04X1A-03** ■

E14 [Led / Fluo / Hal] max. 40W

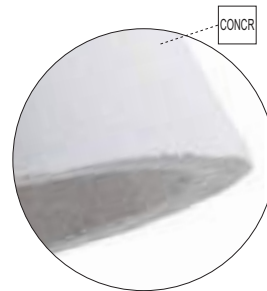
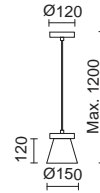

**683B-G04X1A-03** ■

3x E14 [Led / Fluo / Hal] max. 40W

Lámparas recomendadas  
Recommended lamps  
Lampes recommandées  
Lâmpadas recomendadas

LED FILAMENT



pag. 272

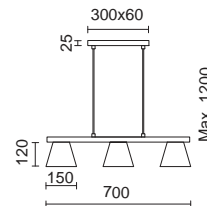



# Nae

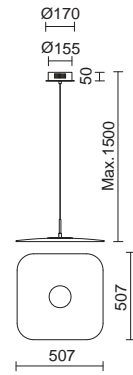

797A-L0121B-92 ■

LED SMD 21W 1394lm 3000K







# Dora



594A-G05X1A-01 □

E27 [Led / Fluo / Hal] max. 60W

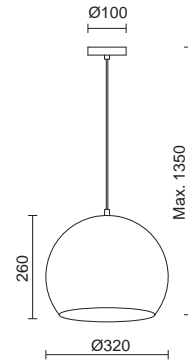

Lámparas recomendadas / Recommended lamps  
Lampes recommandées / Lâmpadas recomendadas

LED FILAMENT



pag. 272

# Eyra Glass

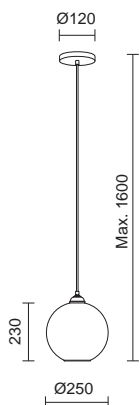

597A-G05X1A-01 □  
E27 [Led / Fluo / Hal] max. 60W

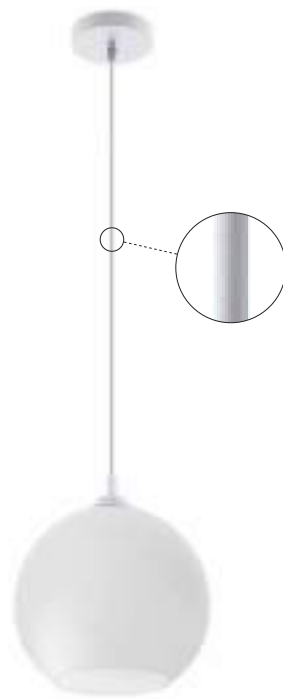

Lámparas recomendadas / Recommended lamps  
Lampes recommandées / Lâmpadas recomendadas

LED FILAMENT



pag. 272

# Brenda



725A-G05X1A-29

E27 [Led / Fluo / Hal] max. 60W

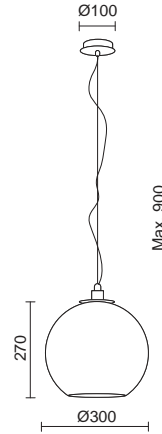

Lámparas recomendadas  
Recommended lamps  
Lampes recommandées  
Lâmpadas recomendadas

LED FILAMENT



pag. 272

# Cupertino



699A-L0105B-37

LED SMD 4,8W 240lm 3000K



# Gilda



698A-LO105B-37 ■

LED SMD 4,8W 240lm 3000K

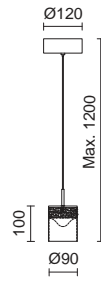

# Aliya



584B-LO1H4A-01 □

LED COB 4x 10W 4x 900lm 3000K

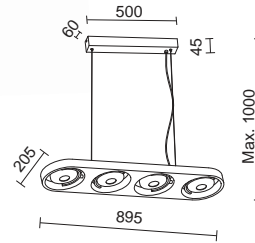

# Fred



- A20A-715-01
- A20A-715-02
- A20A-715-03



- 715A-L0125A-01
- 715A-L0125A-02
- 715A-L0125A-03

LED SMD 25W 1850lm 3000K

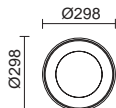
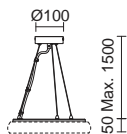

715A-L0125A-01 + A20A-715-01



715A-L0125A-02 + A20A-715-02



715B-L3135A-03 + A20A-715-03



- 715B-L3135A-01
- 715B-L3135A-02
- 715B-L3135A-03

LED SMD 35W 2940lm 3000K

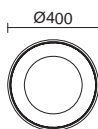
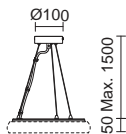



Lámpara no incluida / Lamp not included / Lampade pas inclus / Lâmpada não incluído

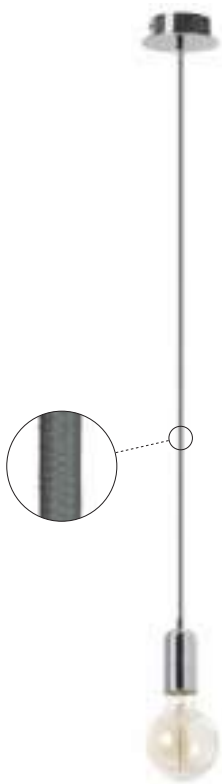

717D-G05X1A-01

717D-G05X1A-02

717D-G05X1A-32

E27 [Led / Vintage] max. 60W

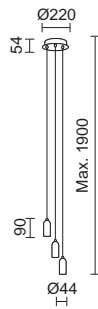
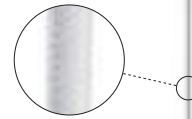

717E-G05X1A-01

717E-G05X1A-02

717E-G05X1A-32

E27 [Led / Vintage] 3x max. 60W



717F-G05X1A-01

717F-G05X1A-02

717F-G05X1A-32

E27 [Led / Vintage] 5x max. 60W

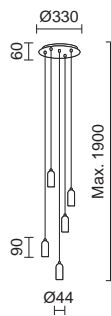

Lámparas recomendadas  
Recommended lamps  
Lampes recommandées  
Lâmpadas recomendadas

LED FILAMENT



pag. 272





# Selene



Lámpara no incluida / Lamp not included / Lampade pas inclus / Lâmpada não incluído



728A-G05X1A-02 ■

728A-G05X1A-35 ●

728A-G05X1A-37 ■

E27 [Led / Fluo / Hal] max. 60W

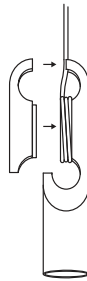
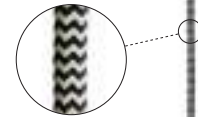
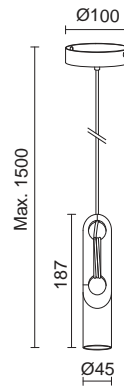

Lámparas recomendadas / Recommended lamps  
Lampes recommandées / Lâmpadas recomendadas

LED FILAMENT



pag. 272



lux.com



# Aprilla



Lámpara no incluida / Lamp not included / Lampade pas inclus / Lâmpada não incluído



499A-G05X1A-39 ■

E27 [Led / Fluo / Hal] max. 60W

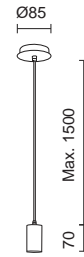

Lámparas recomendadas / Recommended lamps  
Lampes recommandées / Lâmpadas recomendadas

LED FILAMENT



pag. 272



# Kaira



605A-C04X1A-10 □

E14 [Led / Fluo / Hal] max. 40W



01

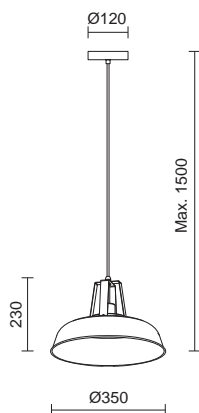

exo

Lámparas recomendadas  
Recommended lamps  
Lampes recommandées  
Lâmpadas recomendadas

LED FILAMENT



pag. 272

# Cloé

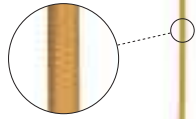

50

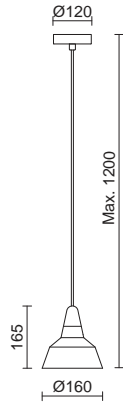

680B-G04X1A-13 ■

E14 [Led / Fluo / Hal] max. 40W

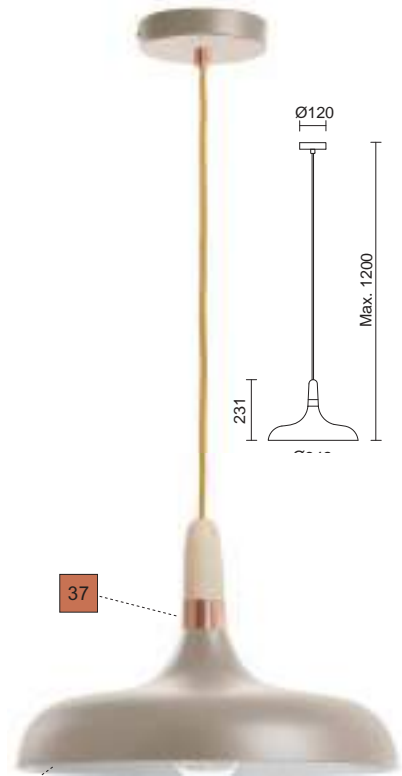

37

01

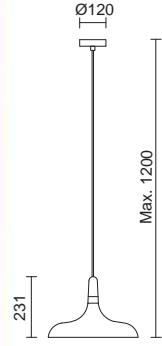

680C-G05X1A-13 ■

E27 [Led / Fluo / Hal] max. 60W

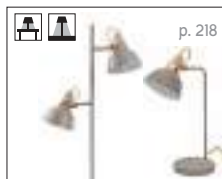

Lámparas recomendadas / Recommended lamps  
Lampes recommandées / Lâmpadas recomendadas

LED FILAMENT



pag. 272



MENU  
food and drink

# Lírica



844A-G05X1A-01

844A-G05X1A-03

E27 [Led / Fluo / Hal] max. 60W

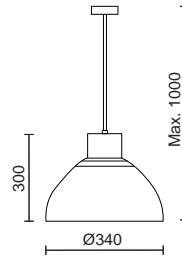

Lámparas recomendadas / Recommended lamps  
Lampes recommandées / Lâmpadas recomendadas

LED FILAMENT



pag. 272





# Valan

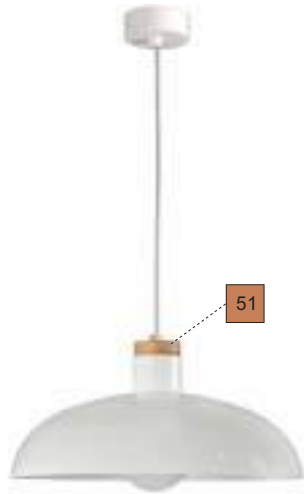

846A-G05X1A-01 □

E27 [Led / Fluo / Hal] max. 60W

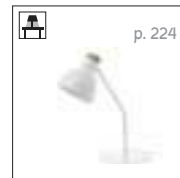
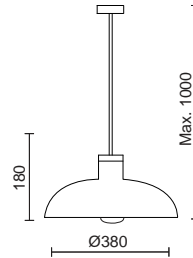

Lámparas recomendadas / Recommended lamps  
Lampes recommandées / Lâmpadas recomendadas

LED FILAMENT



pag. 272

# Lacio



843A-G05X1A-01 □

E27 [Led / Fluo / Hal] max. 60W

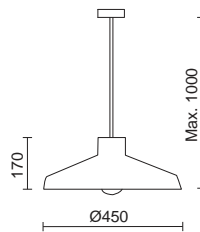

Lámparas recomendadas / Recommended lamps  
Lampes recommandées / Lâmpadas recomendadas

LED FILAMENT



pag. 272



# Antiq



01

**585A-G05X 1A-02 ■**

E27 [Led / Fluo / Hal] max. 60W

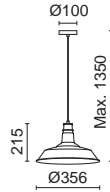

# Vintage

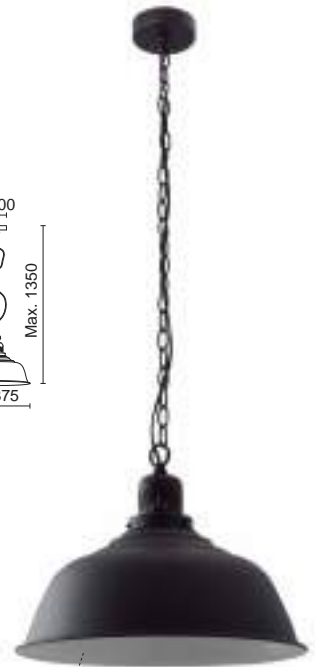

03

**620A-G05X 1A-02 ■**

E27 [Led / Fluo / Hal] max. 60W



Lámparas recomendadas / Recommended lamps  
Lampes recommandées / Lâmpadas recomendadas

LED FILAMENT



pag. 272



# Livia



682A-G05X1A-91 ■

E27 [Led / Fluo / Hal] max. 60W

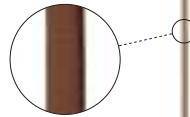
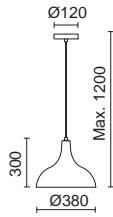

01

Lámparas recomendadas / Recommended lamps  
Lampes recommandées / Lâmpadas recomendadas

LED FILAMENT



pag. 272



# Tanna

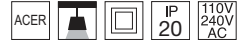

94

618A-G05X1A-02 ■

E27 [Led / Fluo / Hal] max. 60W

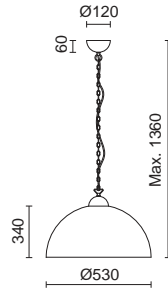

Lámparas recomendadas / Recommended lamps  
Lampes recommandées / Lâmpadas recomendadas

LED FILAMENT



pag. 272





# Olivia

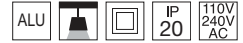

**N** 610A-G05X1A-01

**N** 610A-G05X1A-02

610A-G05X1A-42

E27 [Led / Fluo / Hal] max. 60W

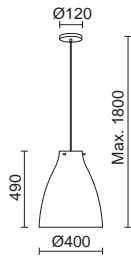

01

# Bell

586A-G05X1A-01

E27 [Led / Fluo / Hal] max. 60W

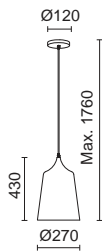

01

Lámparas recomendadas / Recommended lamps  
Lampes recommandées / Lâmpadas recomendadas

LED FILAMENT



pag. 272



# Camila



601A-G05X1A-32

601A-G05X1A-37

E27 [Led / Fluo / Hal] max. 60W

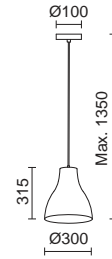

Lámparas recomendadas / Recommended lamps  
Lampes recommandées / Lâmpadas recomendadas

LED FILAMENT



pag. 272

# Mildred



608A-G05X 1A-40 

E27 [Led / Fluo / Hal] max. 60W

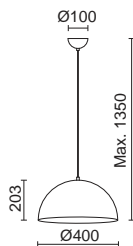

Lámparas recomendadas / Recommended lamps  
Lampes recommandées / Lâmpadas recomendadas

LED FILAMENT



pag. 272

# Dina



593A-L0108A-01

593A-L0108A-03

LED SMD 8W 500lm 3000K

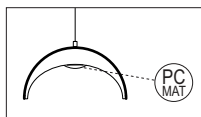
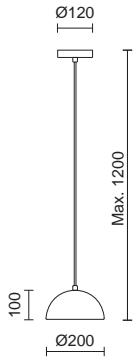









Pie y sobremesa  
Floor and table lamps  
Lampadaires et lampes à poser  
Pé e Mesa

new

# Diagonal

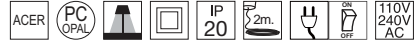

Pantalla no incluida / Shade not included / Abat-Jour exclu / Abajur não incluido



By Nacho Timón



855A-C05X1A-01

855A-C05X1A-02

855A-C05X1A-37

E27 [Led] max. 13W

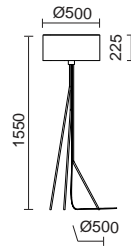

855A-C05X1A-02 + A31A-004-SA

855A-C05X1A-02 + A31A-004-SM

Pantallas disponibles / Available shades  
Abat-Jours disponibles / Abajures disponíveis

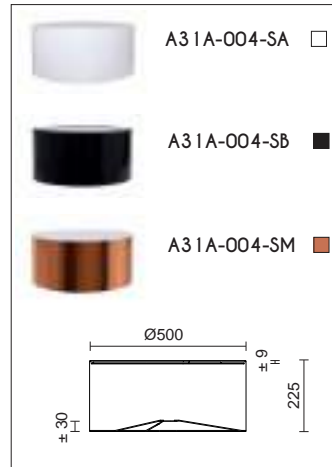

Lámparas recomendadas  
Recommended lamps  
Lampes recommandées  
Lâmpadas recomendadas

LED FILAMENT



pag. 272





new

# Diagonal



By Nacho Timón



Pantalla no incluida / Shade not included / Abat-Jour exclu / Abajur não incluído



855C-G05X1A-01 + A31C-004-SA



855C-G05X1A-01 + A31C-004-SB



855C-G05X1A-01 + A31C-004-SM

855C-G05X1A-01 855C-G05X1A-02 855C-G05X1A-37 

E27 (Ø45) [Led] max. 13W

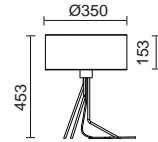

Pantallas disponibles / Available shades  
Abat-Jours disponibles / Abajures disponíveis

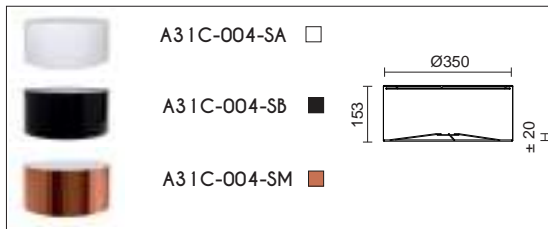

Lámparas recomendadas  
Recommended lamps  
Lampes recommandées  
Lâmpadas recomendadas

LED FILAMENT



pag. 272



855B-G05X1A-01 + A31B-004-SA



855B-G05X1A-01 + A31B-004-SB



855B-G05X1A-01 + A31B-004-SM

855B-G05X1A-01 855B-G05X1A-02 855B-G05X1A-37 

E27 (Ø45) [Led] max. 13W

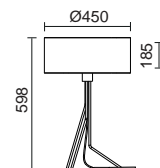

Lámparas recomendadas  
Recommended lamps  
Lampes recommandées  
Lâmpadas recomendadas

LED FILAMENT



pag. 272

Pantallas disponibles / Available shades  
Abat-Jours disponibles / Abajures disponíveis

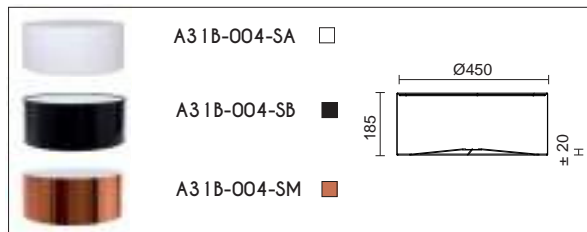



new

# Kai



Pantalla incluida / Shade included / Écran inclus / Abajur incluido

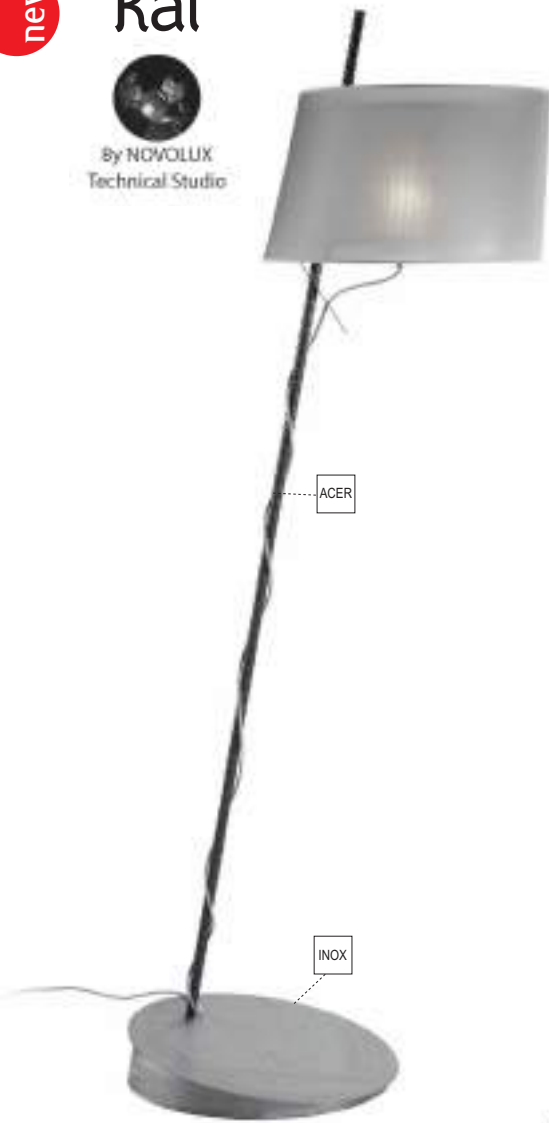

**856A-G05X1A-43** □

E27 [Led / Fluó / Hal] max. 60W

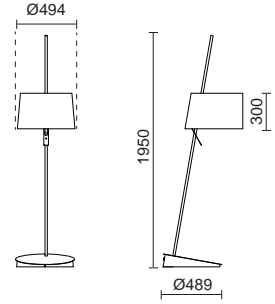
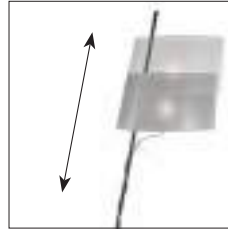

Lámparas recomendadas  
Recommended lamps  
Lampes recommandées  
Lâmpadas recomendadas



pag. 272



**856B-G05X1A-43** □

E27 (Ø45) [Led / Fluó / Hal] max. 40W

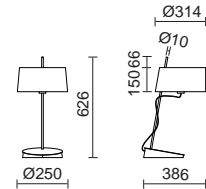



# Tess



**837A-G05X1A-01** □

E27 [Led / Fluo / Hal] max. 60W

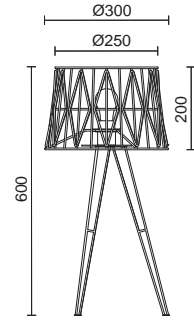

**837B-G05X1A-01** □

E27 [Led / Fluo / Hal] max. 60W

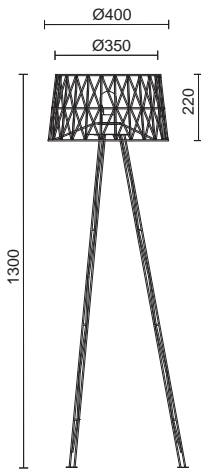

Lámparas recomendadas / Recommended lamps  
Lampes recommandées / Lâmpadas recomendadas

LED FILAMENT



pag. 272

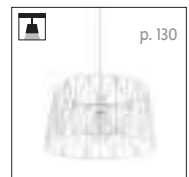





new

## Sintra



Pantalla incluida / Shade included / Écran inclus / Abajur incluido

**917A-G05X1A-02-CA ■**

E27 [Led / Fluo / Hal] max. 60W

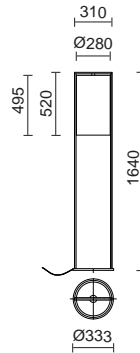
**917B-G05X1A-02-CA ■**

E27 [Led / Fluo / Hal] max. 40W

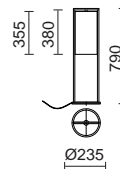

LED FILAMENT



pag. 272



new

# Amsterdam



Pantalla no incluida / Shade not included / Abat-Jour exclu / Abajur não incluido



909A-G05X1A-01 + A29B-004-CB



909A-G05X1A-01 + A29B-004-CG



909B-G05X1A-01 + A29C-004-CA



909B-G05X1A-02 + A29C-004-CG



909A-G05X1A-01

909A-G05X1A-02

E27 [Led / Fluó / Hal] max. 60W

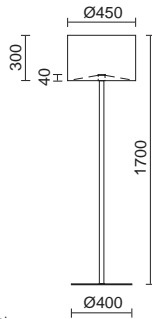

909B-G05X1A-01

909B-G05X1A-02

E27 [Led / Fluó / Hal] max. 40W

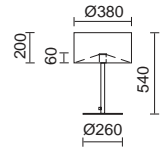

Pantallas disponibles / Available shades  
Abat-Jours disponibles / Abajures disponíveis

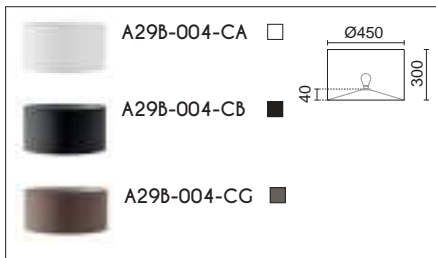

Pantallas disponibles / Available shades  
Abat-Jours disponibles / Abajures disponíveis

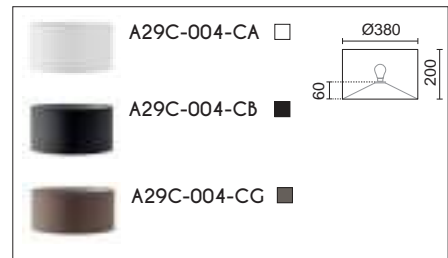

Lámparas recomendadas / Recommended lamps  
Lampes recomendadas / Lâmpadas recomendadas

LED FILAMENT



pag. 272





# Firenze



Pantalla no incluida / Shade not included / Abat-Jour exclu / Abajur não incluido



507C-G05X1A-35 + A26C-004-CA



**507C-G05X1A-35** ■

E27 [Led / Fluo / Hal] max. 60W

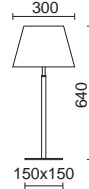
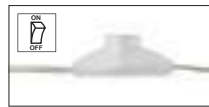

507D-G05X1A-35 + A26B-004-CB



**507D-G05X1A-35** ■

E27 [Led / Fluo / Hal] max. 60W



Pantallas disponibles / Available shades  
Abat-jours disponibles / Abajures disponiveis

	A26C-004-CA □	
	A26C-004-CC ■	
	A26C-004-CB ■	
	A27C-004-CA □	
	A27C-004-CC ■	
	A27C-004-CB ■	



Pantallas disponibles / Available shades  
Abat-jours disponibles / Abajures disponiveis

	A26B-004-CA □	
	A26B-004-CC ■	
	A26B-004-CB ■	
	A27B-004-CA □	
	A27B-004-CC ■	
	A27B-004-CB ■	

Lámparas recomendadas  
Recommended lamps  
Lampes recommandées  
Lâmpadas recomendadas

LED FILAMENT



pag. 272

▲ Otras acabados de pantalla bajo pedido, pag. 283  
Other shade finishes available upon request, pag. 283  
Autres finitions des abat-jours sur demande, pag. 283  
Outros acabamentos para os Abajures sob pedido, pag. 283



# Eda



Pantalla no incluida / Shade not included / Abat-Jour exclu / Abajur não incluído



596C-Y05X1A-32 + A26B-004-CC

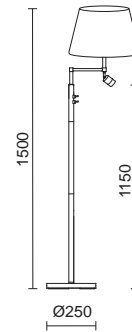
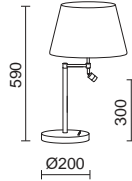

596B-Y05X1A-32 + A26B-004-CB



## 596C-Y05X1A-32 □

E27 [Led / Fluo / Hal] max. 60W

+ LED SMD 3W 240lm 3000K

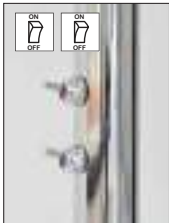

## 596B-Y05X1A-32 □

E27 [Led / Fluo / Hal] max. 60W

+ LED SMD 3W 240lm 3000K

Pantallas disponibles / Available shades / Abat-Jours disponibles / Abajures disponíveis

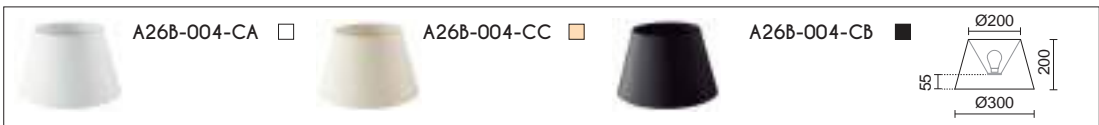

▲ Otros acabados de pantalla bajo pedido, pag. 283 / Other shade finishes available upon request, pag. 283  
Autres finitions des abat-jours sur demande, pag. 283 / Outros acabamentos para as Abajures sob pedido, pag. 283



p. 58

Lámparas recomendadas / Recommended lamps  
Lampes recommandées / Lâmpadas recomendadas

LED FILAMENT



pag. 272





# Oval

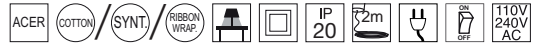

Pantalla no incluida / Shade not included / Abat-Jour exclu / Abajur não incluído



611F-G05X1A-35 + A28C-004-CA



611F-G05X1A-35 + A28C-004-RC

611F-G05X1A-35 ■

E27 [Led / Fluo / Hal] max. 60W

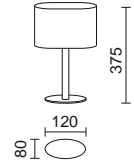

Pantallas disponibles / Available shades / Abat-Jours disponibles / Abajures disponíveis

	A28A-004-CA <input type="checkbox"/>	A28A-004-CC <input type="checkbox"/>	<b>N</b> A28A-004-CB <input checked="" type="checkbox"/>	
	<b>N</b> A28A-004-SA <input type="checkbox"/>	<b>N</b> A28A-004-SB <input checked="" type="checkbox"/>		
	<b>N</b> A28A-004-RA <input type="checkbox"/>	<b>N</b> A28A-004-RC <input type="checkbox"/>		



611E-G05X1A-35 + A28C-004-CA



611E-G05X1A-35 + A28C-004-SB

611E-G05X1A-35 ■

E27 [Led / Fluo / Hal] max. 60W

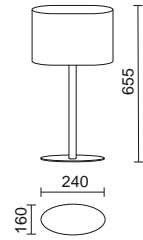

Pantallas disponibles / Available shades / Abat-Jours disponibles / Abajures disponíveis

	A28C-004-CA <input type="checkbox"/>	A28C-004-CC <input type="checkbox"/>	<b>N</b> A28C-004-CB <input checked="" type="checkbox"/>	
	<b>N</b> A28C-004-SA <input type="checkbox"/>	<b>N</b> A28C-004-SB <input checked="" type="checkbox"/>		
	<b>N</b> A28C-004-RA <input type="checkbox"/>	<b>N</b> A28C-004-RC <input type="checkbox"/>		



Lámparas recomendadas  
Recommended lamps  
Lampes recommandées  
Lâmpadas recomendadas

LED FILAMENT



pag. 272





# Oval

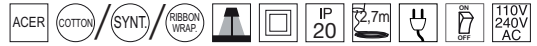

Pantalla no incluida / Shade not included / Abat-Jour exclu / Abajur não incluído



611D-G05X1A-35 + A28B-004-SB



611D-G05X1A-35 + A28B-004-RA

611D-G05X1A-35 ■

E27 [Led / Fluo / Hal] max. 60W

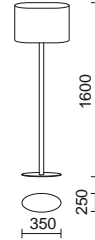

Pantallas disponibles / Available shades / Abat-Jours disponibles / Abajures disponíveis

COTTON	A28B-004-CA <input type="checkbox"/>	A28B-004-CC <input type="checkbox"/>	<b>N</b> A28B-004-CB <input checked="" type="checkbox"/>
SYNT	<b>N</b> A28B-004-SA <input type="checkbox"/>	<b>N</b> A28B-004-SB <input checked="" type="checkbox"/>	
RIBBON WRAP	<b>N</b> A28B-004-RA <input type="checkbox"/>	<b>N</b> A28B-004-RC <input type="checkbox"/>	



Lámparas recomendadas  
Recommended lamps  
Lampes recomandées  
Lâmpadas recomendadas



pag. 272



# Gina



Pantalla no incluida / Shade not included / Abat-Jour exclu / Abajur não incluído



600F-G05X1A-35 + A36C-004-CC

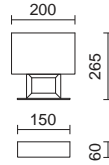

**600F-G05X1A-35** ●

E27 [Led / Fluo / Hal] max. 60W



Pantallas disponibles / Available shades / Abat-Jours disponibles / Abajures disponíveis



▲ Otros acabados de pantalla bajo pedido, pag. 283 / Other shade finishes available upon request, pag. 283  
Autres finitions des abat-jours sur demande, pag. 283 / Outros acabamentos para os Abajures sob pedido, pag. 283

**600E-G05X1A-35** ●

E27 [Led / Fluo / Hal] max. 60W

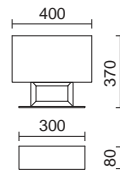

600E-G05X1A-35 + A36B-004-CA

Pantallas disponibles / Available shades / Abat-Jours disponibles / Abajures disponíveis



▲ Otros acabados de pantalla bajo pedido, pag. 283 / Other shade finishes available upon request, pag. 283  
Autres finitions des abat-jours sur demande, pag. 283 / Outros acabamentos para os Abajures sob pedido, pag. 283



p. 48

Lámparas recomendadas / Recommended lamps  
Lampes recommandées / Lâmpadas recomendadas

**LED FILAMENT**



pag. 272

# Gina



Pantalla no incluida / Shade not included / Abat-Jour exclu / Abajur não incluído

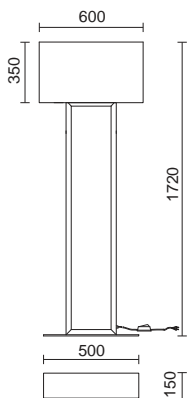

600D-C05X1A-35

2x E27 [Led / Fluo / Hal] max. 60W



Pantallas disponibles / Available shades  
Abat-Jours disponibles / Abajures disponíveis

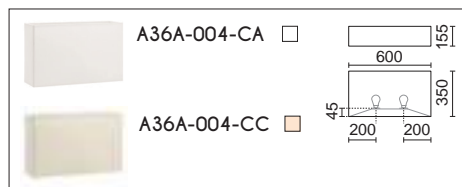

▲ Otros acabados de pantalla bajo pedido, pag. 283  
Other shade finishes available upon request, pag. 283  
Autres finitions des abat-jours sur demande, pag. 283  
Outros acabamentos para os Abajures sob pedido, pag. 283

Lámparas recomendadas / Recommended lamps  
Lampes recommandées / Lâmpadas recomendadas

LED FILAMENT



pag. 272



# Iris



Pantalla no incluida / Shade not included / Abat-Jour exclu / Abajur não incluído



602A-G05X1A-32 + A33A-004-CA

602A-G05X1A-32

E27 [Led / Fluo / Hal] max. 60W

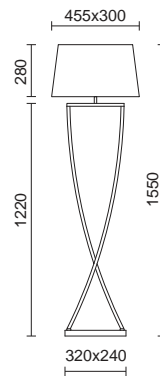
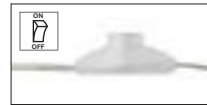

Pantallas disponibles / Available shades  
Abat-Jours disponibles / Abajures disponíveis

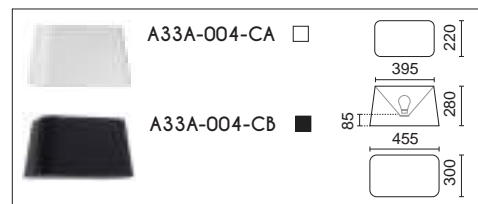

▲ Otros acabados de pantalla bajo pedido, pag. 283  
Other shade finishes available upon request, pag. 283  
Autres finitions des abat-jours sur demande, pag. 283  
Outros acabamentos para os Abajures sob pedido, pag. 283

Lámparas recomendadas / Recommended lamps  
Lampes recommandées / Lâmpadas recomendadas

LED FILAMENT



pag. 272



# Iris



Pantalla no incluida / Shade not included / Abat-Jour exclu / Abajur não incluído

602B-G05X1A-32

E27 [Led / Fluó / Hal] max 60W

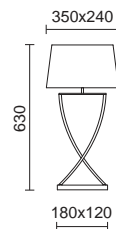

602B-G05X1A-32 + A33B-004-CB

Lámparas recomendadas  
Recommended lamps  
Lampes recommandées  
Lâmpadas recomendadas

LED FILAMENT



pag. 272

Pantallas disponibles / Available shades  
Abat-Jours disponibles / Abajures disponíveis

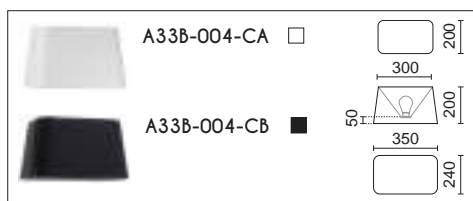

▲ Otros acabados de pantalla bajo pedido, pag. 283  
Other shade finishes available upon request, pag. 283  
Autres finitions des abat-jours sur demande, pag. 283  
Outros acabamentos para os Abajures sob pedido, pag. 283



new

## Ibar

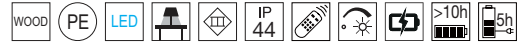
852A-L0100L-50 ■

LED SMD 4W 200lm 3000K

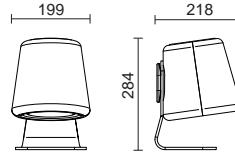

Incluye mando a distancia / Include remote control  
Télécommande incluse / Includi comando à distancia

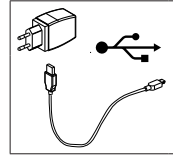
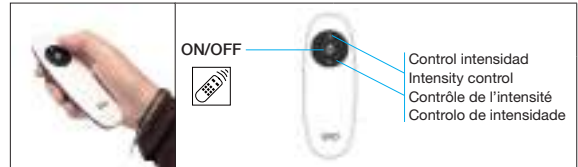

Cargador USB incluido  
USB charger included  
Chargeur USB inclus  
Carregador USB incluido  
5V DC/1A (1 10/240V 50/60Hz)

Enrollacable USB  
USB cable winder  
Enrouleur câble USB  
Carretel de cabo USB



4 intensidades de luz con pulsación directa  
4 light output intensities with direct pulse  
4 Intensités lumineuses avec appuiez directe  
4 intensidades de luz com pulsação direta





# Lars



Pantalla no incluida / Shade not included / Abat-Jour exclu / Abajur não incluído



845A-G05X1A-50 + A26G-004-CA



**845A-G05X1A-50**

E27 [Led / Fluó / Hal] max. 60W

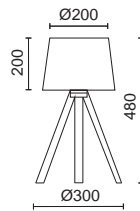
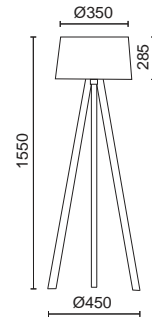

845B-G05X1A-50 + A26B-004-CC



**845B-G05X1A-50**

E27 [Led / Fluó / Hal] max. 60W

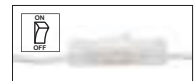

Pantallas disponibles / Available shades  
Abat-Jours disponibles / Abajures disponíveis

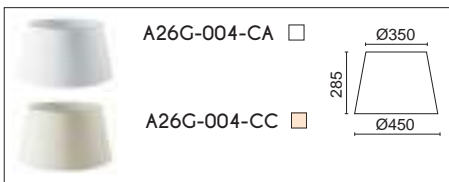

Pantallas disponibles / Available shades  
Abat-Jours disponibles / Abajures disponíveis

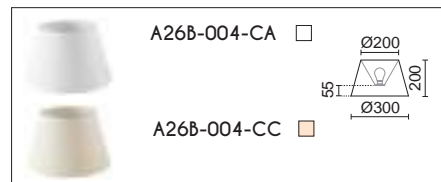

▲ Otros acabados de pantalla bajo pedido, pag. 283 / Other shade finishes available upon request, pag. 283  
Autres finitions des abat-jours sur demande, pag. 283 / Outros acabamentos para os Abajures sob pedido, pag. 283



# Wood

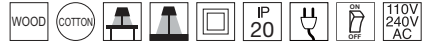

Pantalla no incluida / Shade not included / Abat-Jour exclu / Abajur não incluído

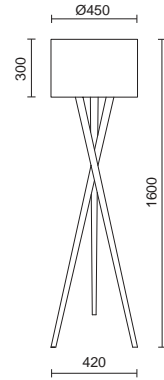

621A-G05X1A-50 + A29B-004-DC

621A-G05X1A-50 ■

E27 [Led / Fluo / Hal] max. 60W

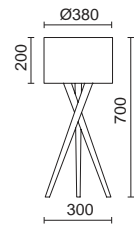

621B-G05X1A-50 + A29C-004-CA

621B-G05X1A-50 ■

E27 [Led / Fluo / Hal] max. 60W

Pantallas disponibles / Available shades  
Abat-Jours disponibles / Abajures disponíveis



Pantallas disponibles / Available shades  
Abat-Jours disponibles / Abajures disponíveis

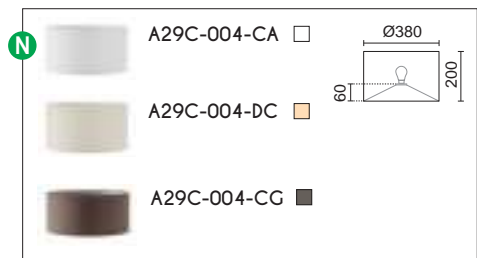

p. 28

Lámparas recomendadas / Recommended lamps  
Lampes recommandées / Lâmpadas recomendadas

LED FILAMENT



pag. 272

▲ Otras acabados de pantalla bajo pedido, pag. 283 / Other shade finishes available upon request, pag. 283  
Autres finitions des abat-jours sur demande, pag. 283 / Outros acabamentos para os Abajures sob pedido, pag. 283



# Kara

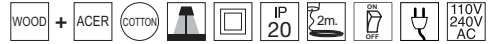

Pantalla no incluida / Shade not included / Abat-Jour exclu / Abajur não incluído

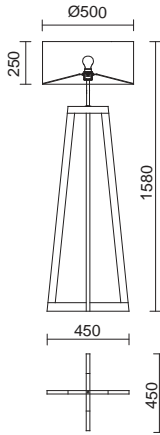

703A-G05X1A-51 ■

E27 [Led / Fluo / Hal] max. 60W



Lámparas recomendadas / Recommended lamps  
Lampes recommandées / Lâmpadas recomendadas

LED FILAMENT



pag. 272

Pantalla disponible / Available shade  
Abat-Jour disponible / Abajur disponível

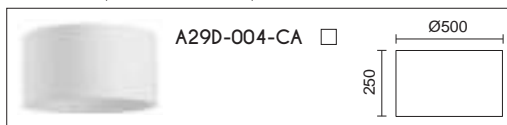

▲ Otros acabados de pantalla bajo pedido, pag. 283 / Other shade finishes available upon request, pag. 283  
Autres finitions des abat-jours sur demande, pag. 283 / Outros acabamentos para os Abajures sob pedido, pag. 283







# Britta



Pantalla no incluida / Shade not included / Abat-Jour exclu / Abajur não incluído



## 68 1C-G05X1A-02 ■

E27 [Led / Fluo / Hal] max. 60W

Pantalla disponible / Available shade  
Abat-Jour disponible / Abajur disponível

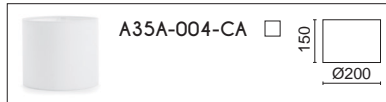

▲ Otros acabados de pantalla bajo pedido, pag. 283  
Other shade finishes available upon request, pag. 283  
Autres finitions des abat-jours sur demande, pag. 283  
Outros acabamentos para os Abajures sob pedido, pag. 283

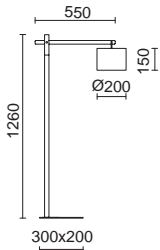

## 68 1B-G05X1A-02 ■

E27 [Led / Fluo / Hal] max. 60W

Pantalla disponible / Available shade  
Abat-Jour disponible / Abajur disponível

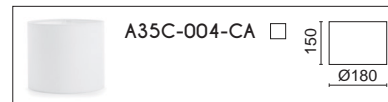

▲ Otros acabados de pantalla bajo pedido, pag. 283  
Other shade finishes available upon request, pag. 283  
Autres finitions des abat-jours sur demande, pag. 283  
Outros acabamentos para os Abajures sob pedido, pag. 283



Lámparas recomendadas / Recommended lamps  
Lampes recommandées / Lâmpadas recomendadas

LED FILAMENT



pag. 272



# Gram



Pantalla no incluida / Shade not included / Abat-Jour exclu / Abajur não incluído

688A-G05X1A-51 ■

E27 [Led / Fluo / Hal] max. 60W

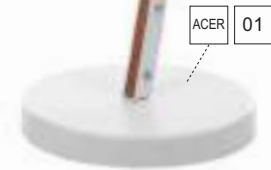
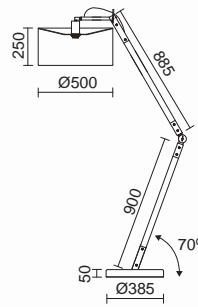

Lámparas recomendadas / Recommended lamps  
Lampes recommandées / Lâmpadas recomendadas

LED FILAMENT



pag. 272

Pantalla disponible / Available shade  
Abat-Jour disponible / Abajur disponível

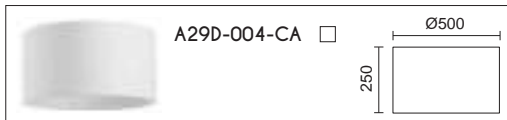

▲ Otros acabados de pantalla bajo pedido, pag. 283 / Other shade finishes available upon request, pag. 283  
Autres finitions des abat-jours sur demande, pag. 283 / Outros acabamentos para os Abajures sob pedido, pag. 283



# Spin



Pantalla no incluida / Shade not included / Abat-Jour exclu / Abajur não incluído

615A-G05X1A-32

E27 [Led / Fluo / Hal] max. 60W

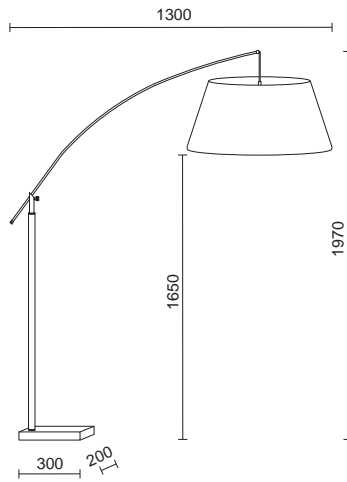
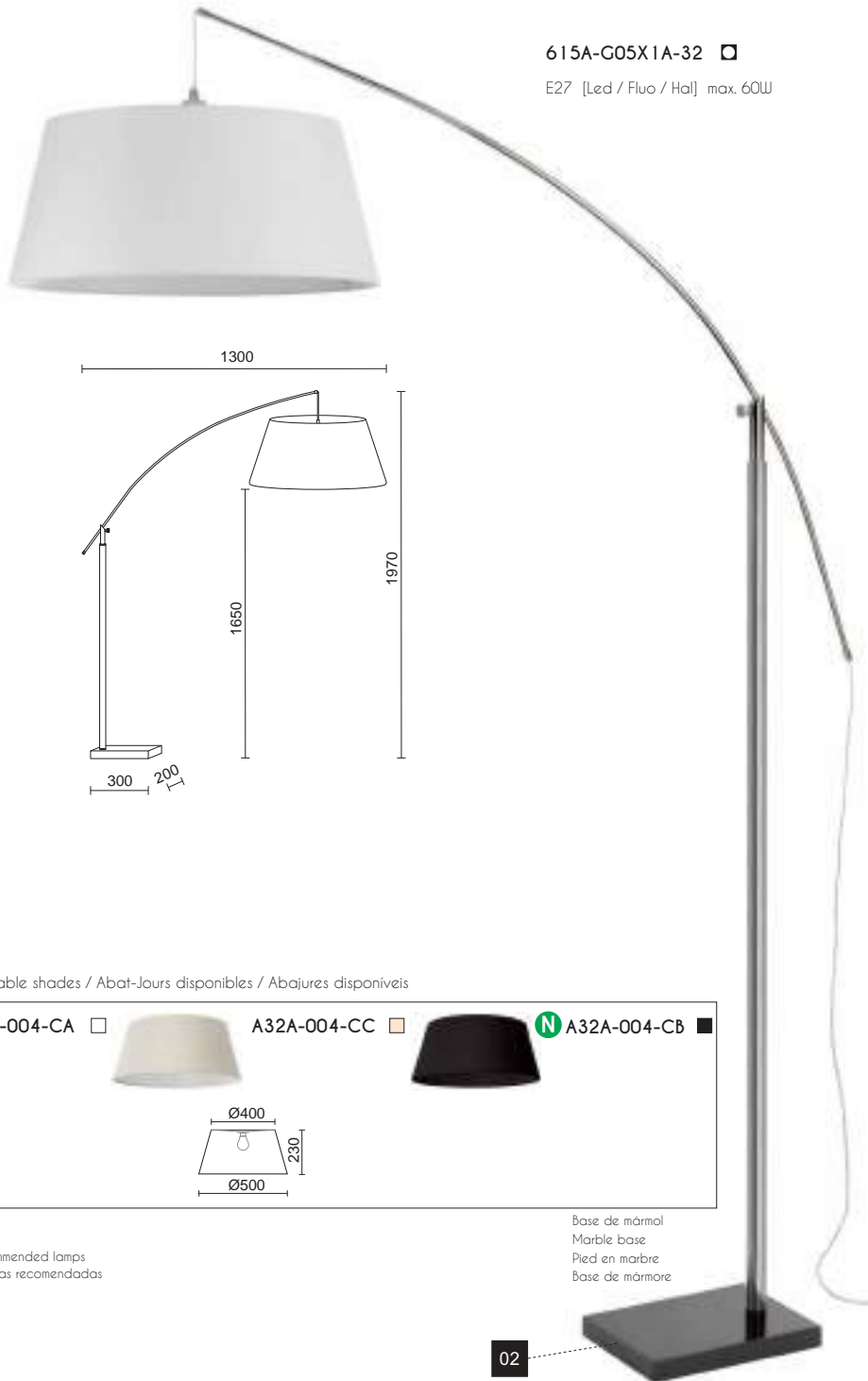

Pantallas disponibles / Available shades / Abat-Jours disponibles / Abajures disponíveis

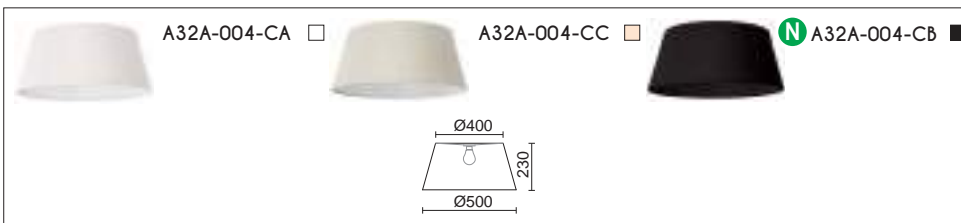

Lámparas recomendadas / Recommended lamps  
Lampes recommandées / Lâmpadas recomendadas

LED FILAMENT



pag. 272

Base de márrol  
Marble base  
Pied en marbre  
Base de mármore

02

615A-G05X1A-32 + A32A-004-CA



# Zanzibar



Pantalla incluida / Shade included / Écran inclus / Abajur incluido

622A-G05X1A-02 ■

E27 [Led / Fluo / Hal] max. 60W

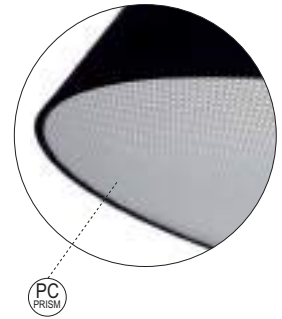
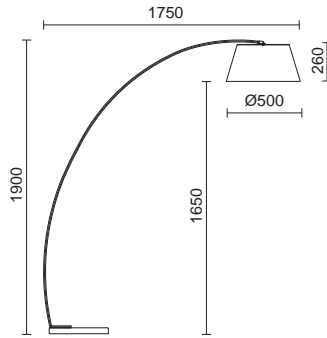
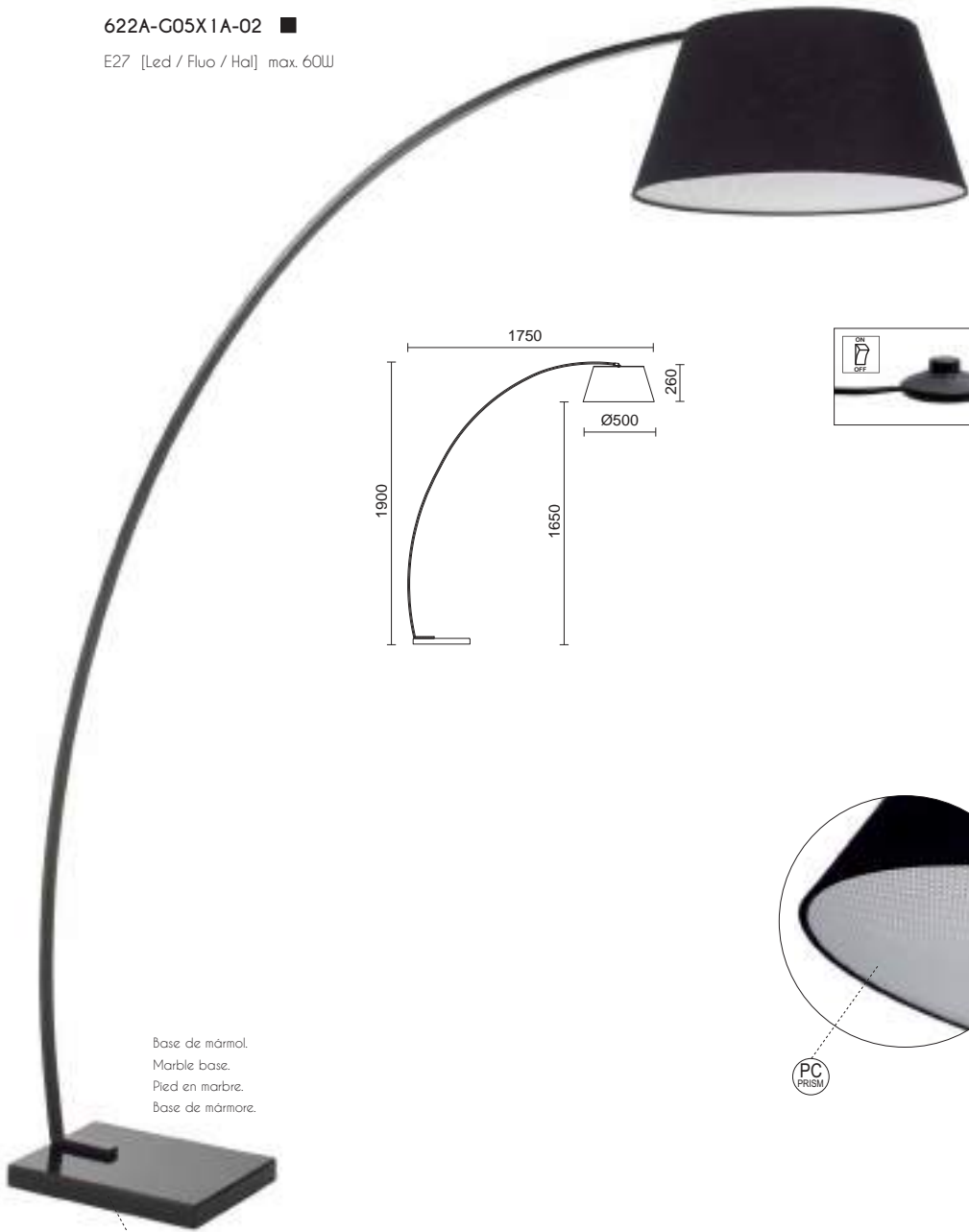

Base de mrmar.  
Marble base.  
Pied en marbre.  
Base de mrmore.

02

Lmparas recomendadas / Recommended lamps  
Lampes recommandes / Lmpadas recomendadas

LED FILAMENT



pag. 272





# Maui

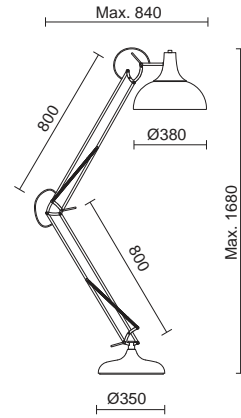

607A-G05X IA-35

E27 [Led / Fluo / Hal] max. 60W



Lámparas recomendadas  
Recommended lamps  
Lampes recommandées  
Lâmpadas recomendadas

LED FILAMENT



pag. 272



# Cloé

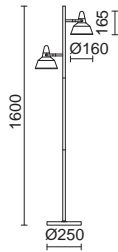
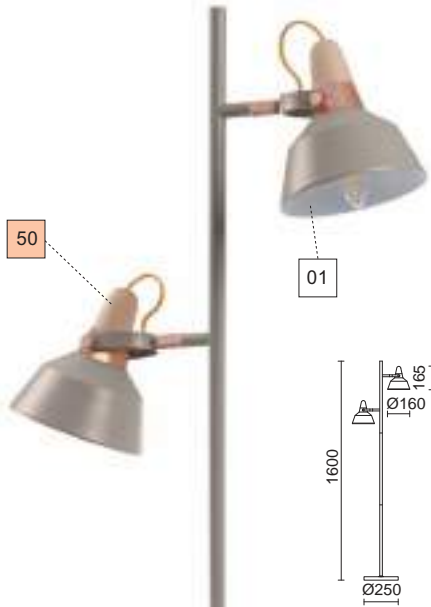

680D-G04X1A-13 ■

2x E14 [Led / Fluo / Hal] max. 40W

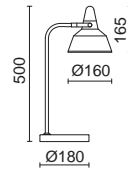

680E-G04X1A-13 ■

E14 [Led / Fluo / Hal] max. 40W



Lámparas recomendadas  
Recommended lamps  
Lampes recommandées  
Lámpadas recomendadas

LED FILAMENT



pag. 272



p. 72



p. 156



1 p. 00



# Oma

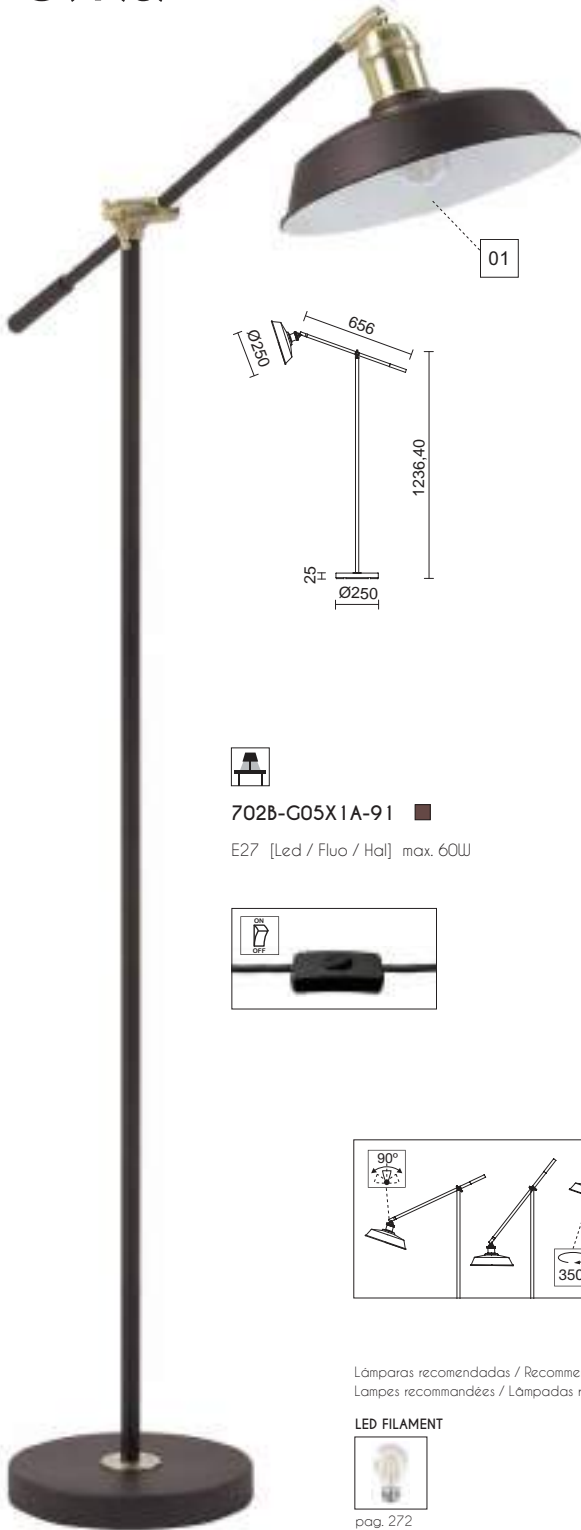

702A-G05X1A-91 ■

E27 [Led / Fluo / Hal] max. 60W



702B-G05X1A-91 ■

E27 [Led / Fluo / Hal] max. 60W

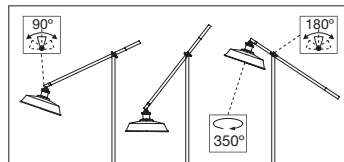
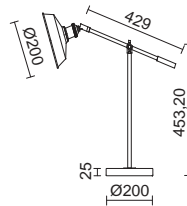

Lámparas recomendadas / Recommended lamps  
Lampes recommandées / Lâmpadas recomendadas

LED FILAMENT



pag. 272

46





# Astrid

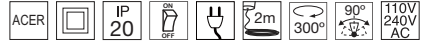

**701B-G05X1A-91 ■**

E27 [Led / Fluo / Hal] max. 60W

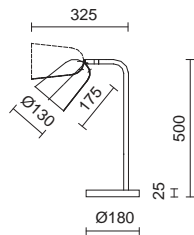

**701A-G05X1A-91 ■**

E27 [Led / Fluo / Hal] max. 60W

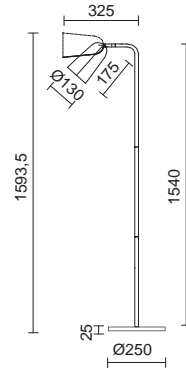
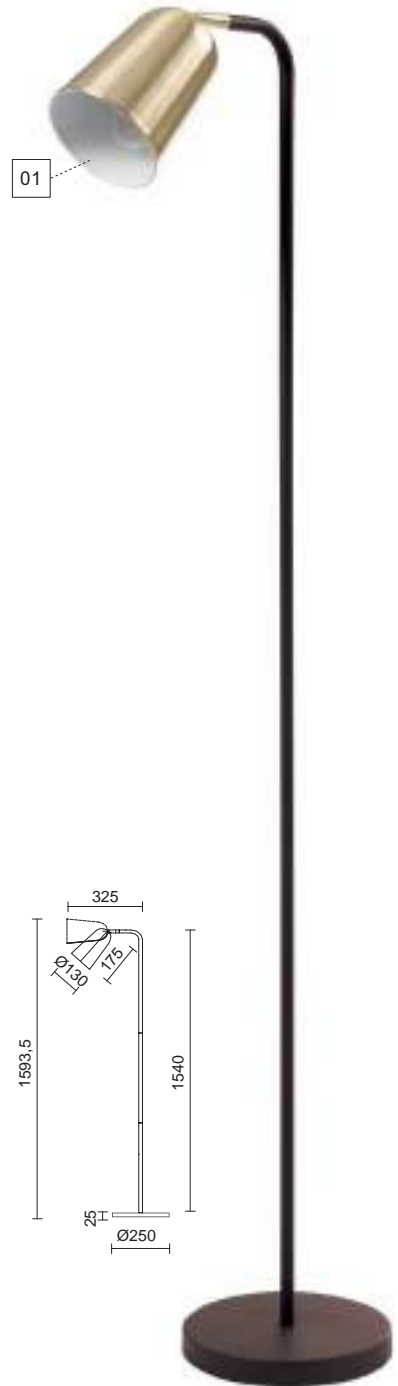

Lámparas recomendadas / Recommended lamps  
Lampes recommandées / Lâmpadas recomendadas

LED FILAMENT



pag. 272





# Valan

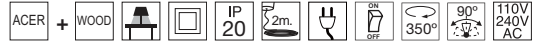

846C-G05X1A-01 □

E27 [Led / Fluo / Hal] max. 60W

51

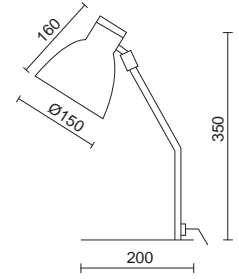

Lámparas recomendadas  
Recommended lamps  
Lampes recommandées  
Lâmpadas recomendadas

LED FILAMENT



pag. 272



# Montecarlo



new



907A-G05X1A-02-CB ■

E27 (Ø45) [Led / Fluo / Hal] max. 60W

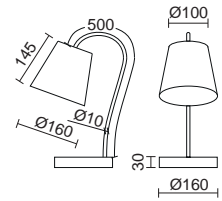

Lámpara recomendada  
 Recommended lamp  
 Lampe recommandé  
 Lâmpada recomendada

	<b>LED FILAMENT Ø45</b>
	<b>300°</b>
	<b>15,000hrs</b>
<b>632H-L0504B-01</b>	
E27 LED 4W 470lm 3000K	



# Skandia

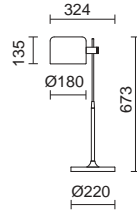
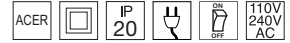

**614A-G05X1A-02** ■

E27 [Led / Fluo / Hal] max. 60W

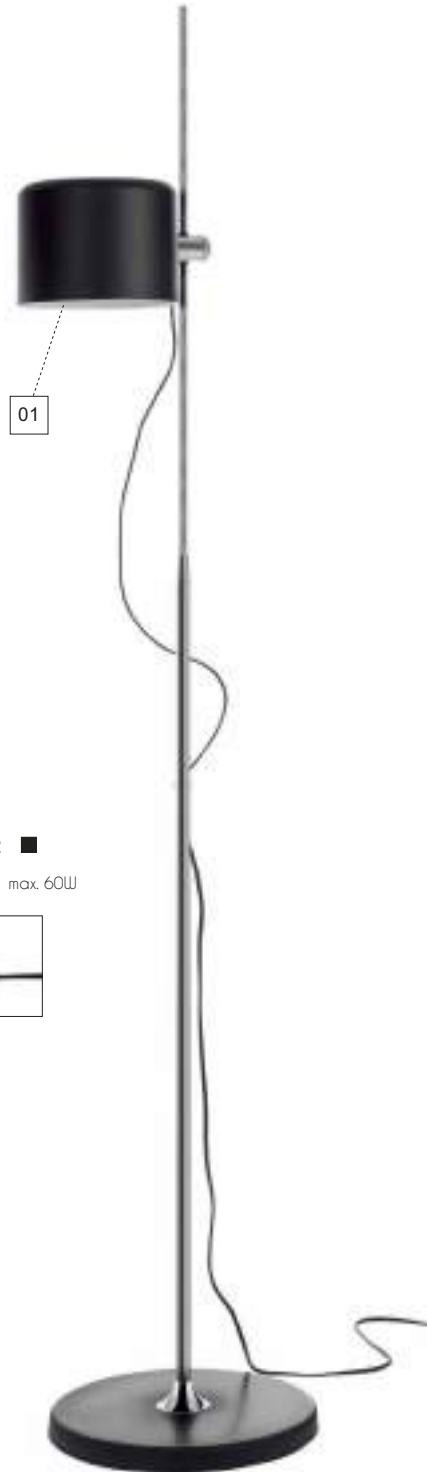

**614B-G05X1A-02** ■

E27 [Led / Fluo / Hal] max. 60W

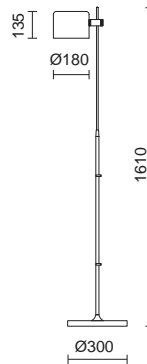

- Altura ajustable.
- Adjustable height.
- Réglable en hauteur.
- Altura ajustável.

Lámparas recomendadas / Recommended lamps  
Lampes recommandées / Lâmpadas recomendadas

LED FILAMENT



pag. 272



# Foc





679A-LO129B-35

LED SMD 28,6W 2000lm 3000K

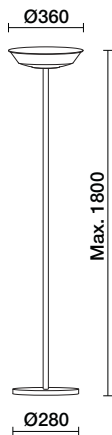

# Flama



598A-L0124B-35   
LED SMD 24W 2100lm 3000K

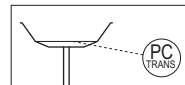

# Albero



**633A-LO1H8A-35**   
 LED SMD 30W 2400lm 3000K  
 +  
 LED SMD 5W 400lm 3000K

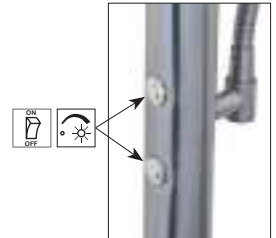
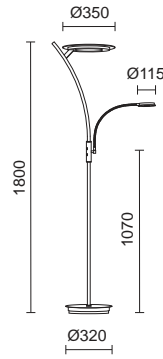





# Study

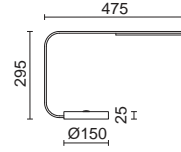

617A-L0105A-39 ■

LED SMD 5W 280lm 3000K



# Book

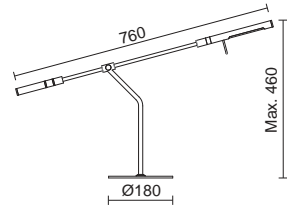

588B-L0104A-02 ■

LED SMD 4W 280lm 3000K

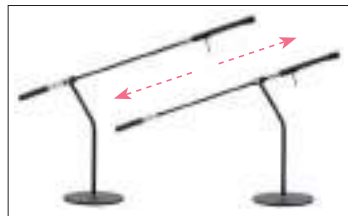







**Baño**  
Bathroom  
Salle de bain  
Banho

## Iluminación y seguridad en el baño

- ZONA 1** Las luminarias tienen que estar protegidas contra los chorros de agua. Mínimo luminarias con IPX5.
- ZONA 2** Las luminarias tienen que estar protegidas contra las salpicaduras de agua. Mínimo luminarias con IPX4 o superior.
- ZONA 3** No existen condiciones especiales de IP para esta zona.

## Bathroom lighting and safety

- ZONE 1** Protection against water jets. IPX5 or above required.
- ZONE 2** Protection from water splashing. IPX4 or above required.
- ZONE 3** No-special restrictions of IP protection.

## Éclairage et sécurité dans la salle de bain

- ZONE 1** Les luminaires doivent être protégés contre les jets d'eau. Minimum IPX5.
- ZONE 2** Les luminaires doivent être protégés contre les projections d'eau. Minimum IPX4 ou plus.
- ZONE 3** Il n'y a pas de conditions spéciales de protection IP.

## Iluminação e segurança no banheiro

- ZONA 1** Luminárias devem ser protegidos contra jatos de água. Mínimos IPX5.
- ZONA 2** luminárias deve ser protegido contra salpicos de água. Luminárias mínimos com IPX4 ou superior.
- ZONA 3** Não há condições especiais IP para esta área.

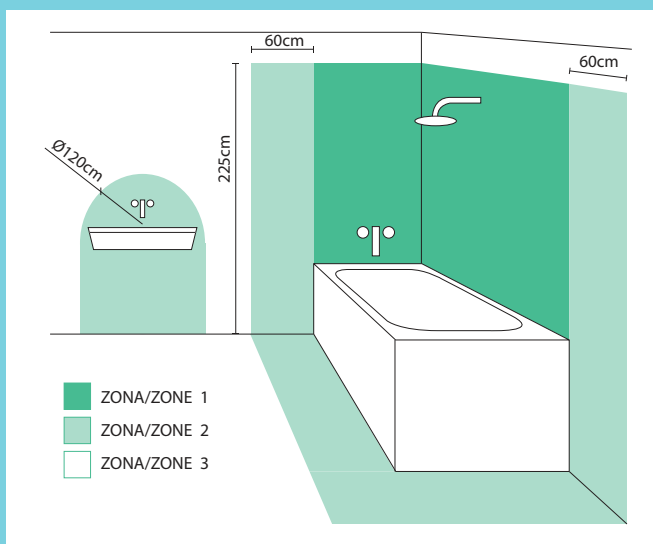

# Krystal



511A-L0103H-29 □

LED SMD 3W 240lm 3000K

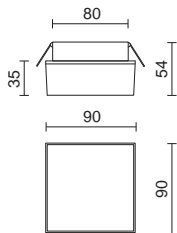

Instalación en placa yeso.  
Installation in plasterboard.  
Installation sur plaque à plâtre.  
Instalação em gesso cartonado.

Alimentador / Power supply / Alimentateur / Alimentador



**B02A-X33 17H-01** □

IN | 10-240 VAC / I OUT 350mA  
Max. 17W IP20  
(max. 4 unit.)

pag. 278



# Dik

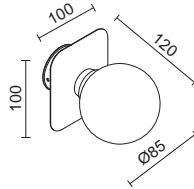

**591B-LO104A-32** □

LED SMD 4W 280lm 3000K

**591A-LO1H5A-32** □

LED SMD 3x 4W 840lm 3000K

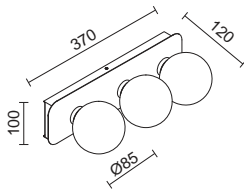

# Sun

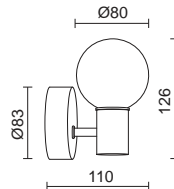

**623A-LO103A-32** □

LED COB 3W 240lm 3000K







# Vel



493A-G04X IA-32 □

E14 [Led / Fluo / Hal] max. 40W

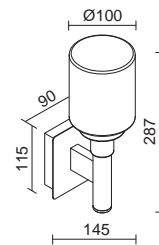

Lámparas recomendadas  
 Recommended lamps  
 Lampes recommandées  
 Lâmpadas recomendadas

**LED FILAMENT**



pag. 272

# Uveg



495A-G04X1A-28 □

E14 [Led / Fluo / Hal] max. 40W

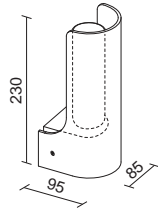

# Bath Classic



712A-G04X1A-46 □

E14 [Led / Fluo / Hal] max. 40W

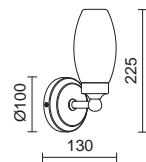

Lámparas recomendadas  
Recommended lamps  
Lampes recommandées  
Lâmpadas recomendadas

LED FILAMENT



pag. 272

# Friss



508A-F02B7B-32 □

2G11 TC-L 2x 18W

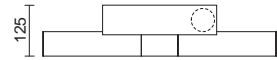
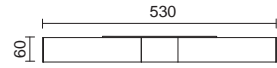

# Sheid



513A-L0109B-32 □

LED SMD 12W 720lm 3000K

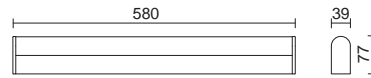

513B-L0112B-32 □

LED SMD 12W 960lm 3000K

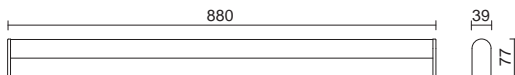

# Lits



## 514A-L0109B-32 □

LED SMD 9W 720lm 3000K

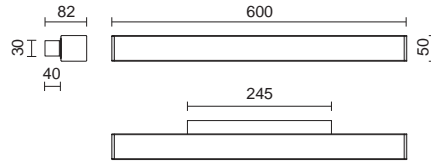

## 514B-L0112B-32 □

LED SMD 12W 960lm 3000K

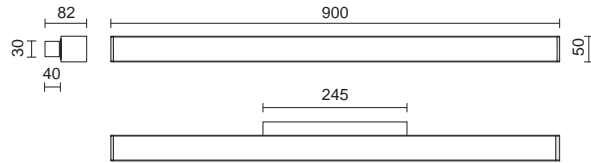

# Desio



494A-G3 1X1A-32 □

GX53 T2 3x 3W

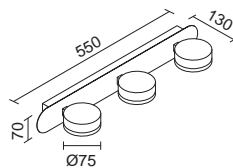

Lámparas recomendadas  
Recommended lamps  
Lampes recommandées  
Lâmpadas recomendadas

LED T2



pag. 271

# Alf



**696A-L0107A-32** □

LED SMD 7W 430lm 3000K

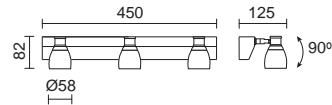

# Dot



**707A-L0105A-32** □

LED SMD 6W 240lm 4000K

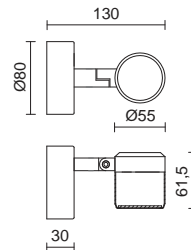



# Moon

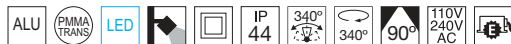

606A-L0105A-01 □  
LED COB 5W 450lm 3000K

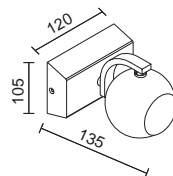

606B-L01G2A-01 □  
2x LED COB 5W 450lm 3000K

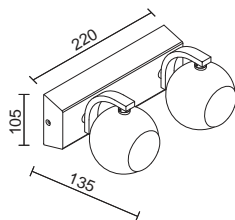

# Tek



32

**677A-L0205B-32** □

LED SMD 6,5W 450lm 4000K

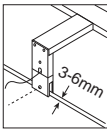
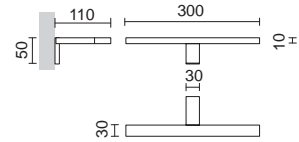

Clip de instalación en espejo incluído.  
 Clip de instalação no espelho incluído.  
 Mirror installation clip included.  
 Clip d'installation du miroir inclus.

# Alin



32

**678A-L0206B-32** □

LED SMD 7W 400lm 4000K

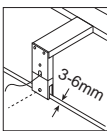
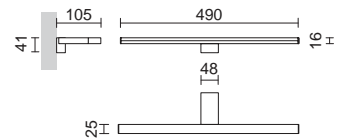

Clip de instalación en espejo incluído.  
 Clip de instalação no espelho incluído.  
 Mirror installation clip included.  
 Clip d'installation du miroir inclus.



# Tiel



**515A-L01D2B-32** □

LED SMD 3x 3W 720lm 3000K

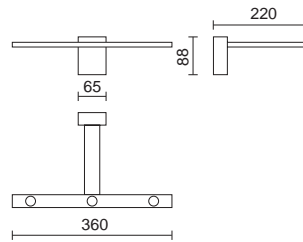







**Ventiladores**  
Ceiling fans  
Ventilateurs  
Fãs

# Fujil

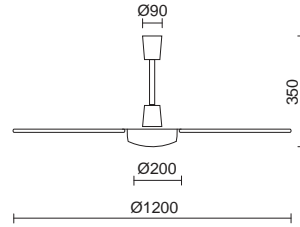
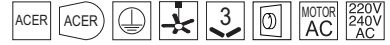

**638A-VX60B-01** □

22,6W - 32,2W - 39,2W - 43,7W - 60W

RPM 195 - 256 - 290 - 307 - 330

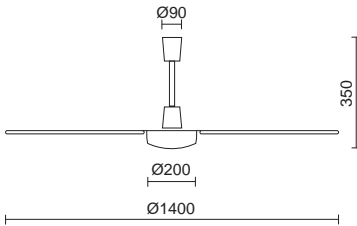

**638B-VX82B-01** □

25,8W - 33,5W - 39,8W - 44,2W - 66,3W

RPM 148 - 187 - 207 - 247 - 295

Instalar en techos altos o naves.  
Install in high ceilings or industrial premises.  
Instaler en plafonds élevés.  
Instalado em tectos altos ou naves industriais.

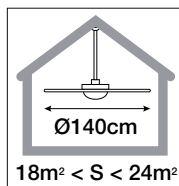
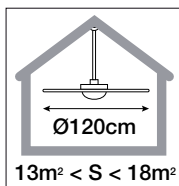
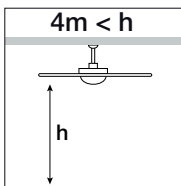



# Cefiro



**637A-WL90B-07** ■

18W - 48,6W - 90,7W

RPM 64 - 115 - 163

LED SMD 18W 1800lm 3000K

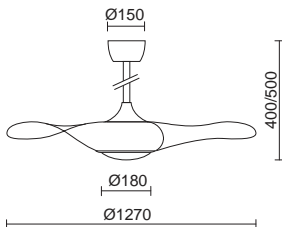

- 2 alturas (40 o 50cm totales) mediante dos tijas incluidas.
- 2 heights (40 or 50cm total) with two rods included.
- 2 hauteurs (40 ou 50cm totale) avec deux tiges incluses.
- 2 alturas (40 o 50cm totales) mediante dos extensões incluído.

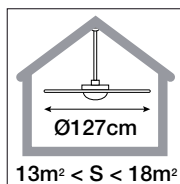
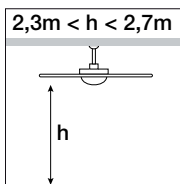

- Acabado rojo transparente.
- Transparent red finishing.
- Finition rouge transparent.
- Acabamento transparente vermelho.



# Vento

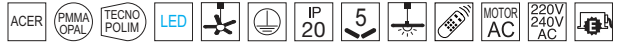

**636A-WL75B-51** ■

17,6W - 43,9W - 75W

RPM 89 - 148 - 192

LED SMD 17W 1700lm 3000K

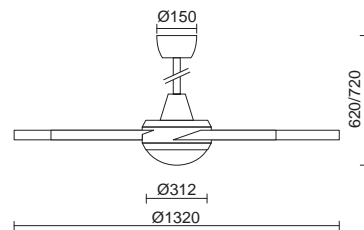

**2,3m < h < 2,7m**

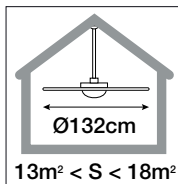
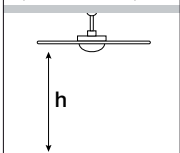

2 alturas (62 o 72cm totales) mediante dos tijas incluidas.  
 2 heights (62 or 72cm total) with two rods included.  
 2 hauteurs (62 ou 72cm totale) avec deux tiges incluses.  
 2 alturas (62 o 72cm totales) mediante dos extensões incluido.



# Marinada



635A-WL58B-01 □

635A-WL58B-03 ■

21,4W - 42,9W - 57,9W

RPM 112 - 175 - 208

LED SMD 13W 1300lm 3000K

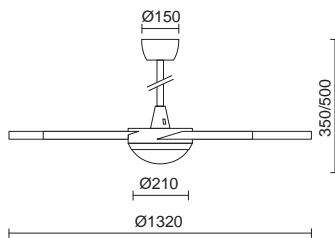

- 2 alturas (35 o 50cm totales) mediante dos tijas incluidas.
- 2 heights (35 or 50cm total) with two rods included.
- 2 hauteurs (35 ou 50cm totale) avec deux tiges incluses.
- 2 alturas (35 o 50cm totales) mediante dos extensões incluido.

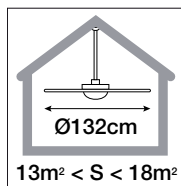
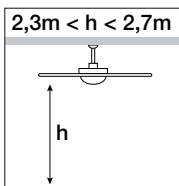







# Accesorios

Accessories  
Accessoires  
Accesórios

# Led strip in





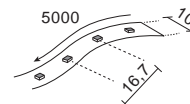

**464A-L0124F-00** 3000°K  
**464A-L0224F-00** 4000°K  
 LED SMD 60leds/m 4,8W/m 360lm/m





**464B-L0105F-00** 3000°K  
**464B-L0205F-00** 4000°K  
 LED SMD 60leds/m 4,8W/m 360lm/m

Alimentadores / Power supplies / Alimentateurs / Alimentadores

	<b>B02Q-X3325F-01</b> 
IN 90-295 VAC OUT 24VDC Max. 25W (max. 1 unit.)	
	<b>B02R-X33A1F-01</b> 
IN 90-295 VAC OUT 24VDC Max. 100W (max. 4 unit.)	

(Pag. 278-279)





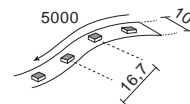

**464A-L0172F-00**  
 LED SMD 60leds/m 3000°K 14,4W/m 1260lm/m





**464B-L0115F-00**  
 LED SMD 60leds/m 3000°K 14,4W/m 1260lm/m

Alimentadores / Power supplies / Alimentateurs / Alimentadores

	<b>B02R-X33A1F-01</b> 
IN 90-295 VAC OUT 24VDC Max. 100W (max. 1 unit.)	
	<b>B02O-X33A4F-39</b> 
IN 90-295 VAC OUT 24VDC Max. 150W (max. 2 unit.)	

(Pag. 278-279)





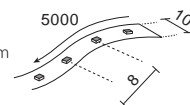

**464C-L0172F-00**  
 LED SMD 120leds/m 3000°K 14,4W/m 1200lm/m





**464D-L0115F-00**  
 LED SMD 120leds/m 3000°K 14,4W/m 1200lm/m

Alimentadores / Power supplies / Alimentateurs / Alimentadores

	<b>B02R-X33A1F-01</b> 
IN 90-295 VAC OUT 24VDC Max. 100W (max. 1 unit.)	
	<b>B02O-X33A4F-39</b> 
IN 90-295 VAC OUT 24VDC Max. 150W (max. 2 unit.)	

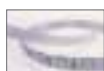
(Pag. 278-279)



Auto-adhs. 3M

\* Longitud de tira led personalizada. Corte en tramos de 5 o 10 cm. Se suministra con 1 toma de alimentación.  
 Bespoke length. Cut in sections of 5 or 10 cm. Comes with 1 power supply.  
 Longueur de ruban Led sur-mesure. Coupe en sections de 5 ou 10 cm. Fourni avec un câble d'alimentation.  
 Comprimento da fita de Led personalizada. Corte por seção de 5 ou 10 cm. Fornece-se com uma tomada de alimentação.



# Led strip in **R G B**



**464A-L0472F-00**

LED SMD RGB 60leds/m 14,4W/m 470lm/m



**464B-L0415F-00**

LED SMD RGB 60leds/m 14,4W/m 470lm/m

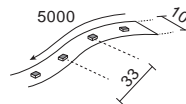

Alimentador / Power supply / Alimentateur / Alimentador



**B020-X3380F-39**

IN 90-305 VAC OUT 24VDC Max. 80W (max. 1 unit.)



**B020-X33A4F-39**

IN 90-295 VAC OUT 24VDC Max. 150W (max. 2 unit.)

(Pag. 278-279)

Sistema control RGB / RGB control system  
Système de contrôle RGB / Sistema de controle RGB



**B05F-G33A9F-39**

432W (max. 2 unit)



30m.

Amplificador / Amplifier / Amplificateur / Amplificador



**B05H-G33A7F-39**

216W (max. 2 unit.)



Precisa transformador adicional  
Additional transformer required  
Nécessite transformateur supplémentaire  
Requer transformador adicional

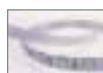

Auto-adhs. 3M

\* Longitud de tira led personalizada. Corte en tramos de 10 cm. Se suministra con 1 toma de alimentación.  
Bespoke length. Cut in sections of 10 cm. Comes with 1 power supply.  
Longueur de ruban Led sur-mesure. Coupe en sections de 10 cm. Fourni avec un câble d'alimentation.  
Cumprimento da fita de Led personalizada. Corte por seção de 10 cm. Fornece-se com uma tomada de alimentação.

# Led strip out



Resina de Poliuretano / Polyurethane resin  
Résine de Polyuréthane / Resina de Poliuretano



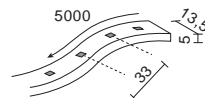

 **465F-L0124F-29** 3000°K  
**465F-L0224F-29** 4000°K  
LED SMD 60leds/m 4,8W/m 310lm/m



\*  **465G-L0105F-29** 3000°K  
**465G-L0205F-29** 4000°K  
LED SMD 60leds/m 4,8W/m 310lm/m

Alimentador / Power supply / Alimentateur / Alimentador

 	<b>B020-X3340F-39</b> IN 90-305 VAC OUT 24VDC Max. 40W (max. 1 unit.)
	<b>B020-X3380F-39</b> IN 90-305 VAC OUT 24VDC Max. 80W (max. 3 unit.)

(Pag. 278-279)



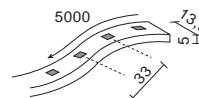

 **465D-L0172F-29**  
LED SMD 60leds/m 3000°K 14,4W/m 630lm/m



\*  **465E-L0115F-29**  
LED SMD 60leds/m 3000°K 14,4W/m 630lm/m

Alimentador / Power supply / Alimentateur / Alimentador

 	<b>B020-X3380F-39</b> IN 90-305 VAC OUT 24VDC Max. 80W (max. 1 unit.)
	<b>B020-X33A4F-39</b> IN 90-295 VAC OUT 24VDC Max. 150W (max. 2 unit.)

(Pag. 278-279)



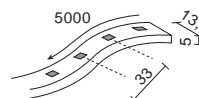

 **465B-L0172F-29**  
LED SMD 120leds/m 3200°K 14,4W/m 1120lm/m



\*  **465C-L0115F-29**  
LED SMD 120leds/m 3200°K 14,4W/m 1120lm/m

Alimentador / Power supply / Alimentateur / Alimentador

 	<b>B020-X3380F-39</b> IN 90-305 VAC OUT 24VDC Max. 80W (max. 1 unit.)
	<b>B020-X33A4F-39</b> IN 90-295 VAC OUT 24VDC Max. 150W (max. 2 unit.)

(Pag. 278-279)

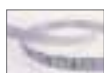

Auto-adhs. 3M

\* Longitud de tira led personalizada. Corte en tramos de 5 o 10 cm. Se suministra con 1 toma de alimentación.  
Bespoke length. Cut in sections of 5 or 10 cm. Comes with 1 power supply.  
Longueur de ruban Led sur-mesure. Coupe en sections de 5 ou 10 cm. Fourni avec un câble d'alimentation.  
Cumprimento da fita de Led personalizada. Corte por seção de 5 ou 10 cm. Fornece-se com uma tomada de alimentação.

# Led strip out



Protector de silicona / Silicone protector  
 Protecteur de silicone / Protetor de silicone



**465A-L0124F-29**

LED SMD 60leds/m 3000K 4,8W/m 240lm/m

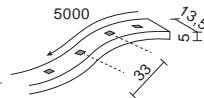

Alimentador / Power supply / Alimentateur / Alimentador

	<b>B020-X3340F-39</b> IN 90-305 VAC OUT 24VDC Max. 40W (max. 1 unit.)
	<b>B020-X33A1F-39</b> IN 90-305 VAC OUT 24VDC Max. 100W (max. 2 unit.)

(Pag. 278-279)



**465F-L0472F-29**

LED SMD RGB 120leds/m 14,4W/m 500lm/m

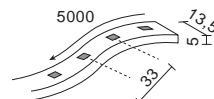

**465G-L0415F-29**

LED SMD RGB 120leds/m 14,4W/m 500lm/m

Alimentador / Power supply / Alimentateur / Alimentador

	<b>B020-X3380F-39</b> IN 90-305 VAC OUT 24VDC Max. 80W (max. 1 unit.)
	<b>B020-X33A4F-39</b> IN 90-295 VAC OUT 24VDC Max. 150W (max. 2 unit.)

(Pag. 278-279)

Sistema control RGB / RGB control system  
 Système de contrôle RGB / Sistema de controle RGB

	<b>B05E-G33A7F-39</b> 288W (max. 2 unit.)									
	<table border="0"> <tr> <td></td> <td></td> <td></td> <td></td> <td></td> </tr> <tr> <td colspan="5">30m.</td> </tr> </table>						30m.			
30m.										

Amplificador / Amplifier / Amplificateur / Amplificador

	<b>B05G-G33A8F-39</b> 216W (max. 2 unit.)			
	<table border="0"> <tr> <td></td> <td></td> <td></td> <td>Precisa transformador adicional Additional transformer required Nécessite transformateur supplémentaire Requer transformador adicional</td> </tr> </table>			
			Precisa transformador adicional Additional transformer required Nécessite transformateur supplémentaire Requer transformador adicional	

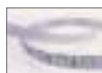

Auto-adhs. 3M

\* Longitud de tira led personalizada. Corte en tramos de 10 cm. Se suministra con 1 toma de alimentación.  
 Bespoke length. Cut in sections of 10 cm. Comes with 1 power supply.  
 Longueur de ruban Led sur-mesure. Coupe en sections de 10 cm. Fourni avec un câble d'alimentation.  
 Cumprimento da fita de Led personalizada. Corte por seção de 10 cm. Fornece-se com uma tomada de alimentação.

# Skoll

## Dispositivos RGB / RGB devices / Dispositifs RGB / Dispositivos RGB



Driver  
Push  
Driver  
Driver

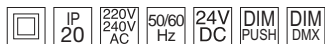

**B02X-X33J2F-00** 3x 16,8W

IN 220-240 VAC OUT 24VDC



Panel controlador DMX táctil de pared, 1 zona RGB  
DMX touch panel controller, 1 RGB zone  
Écran tactile générateur DMX, 1 zone RGB  
Painel controlador DMX táctil de parede, 1 zona RGB



**B05L-X33X2E-00** 12x85x25mm



Decodificador DMX RGB  
RGB DMX decoder  
Décodeur DMX RGB  
Descodificador DMX RGB



**B05I-X33J3F-00** 4x 120W

IN 220-240 VAC OUT 24VDC



Panel controlador DMX táctil de pared, 4 zonas RGBW  
DMX touch panel controller, 4 RGBW zone.  
Écran tactile générateur DMX., 4 zone RGBW  
Painel controlador DMX táctil de parede, 4 zonas RGB



**B05M-X33X2F-00** 80x86x29,10mm



Empotramiento en cajetín universal NO INCLUIDO  
Recessing by flush mounting box NOT INCLUDED  
Encastrement en boîtier universel NON INCLUS  
Encastramento em caixa universal NÃO INCLUÍDA



\* Fuente alimentación / Power Supply / Source d'alimentation / Fonte de alimentação

# Skoll

## Dispositivos RGB / RGB devices / Dispositifs RGB / Dispositivos RGB



Receptor RF RGB  
RGB RF receiver  
Récepteur RF RGB  
Receptor RF RGB



**B05J-X33J4F-00** 3x 120W  
IN 220-240 VAC OUT 24VDC



Mando RF controlador, 4 zonas RGB.  
RF remote controller of 4 RGB zones.  
Télécommande RF, 4 zone RGB.  
Comando RF controlador, 4 zonas RGB.



**B05N-X33X2X-00**



\* Fuente alimentación / Power Supply / Source d'alimentation / Fonte de alimentação.



Amplificador de señal RGB  
RGB power repeater  
Amplificateur de signal RGB  
Amplificador de sinal RGB



**B05K-X33J4F-00** 3x 120W  
IN 220-240 VAC OUT 24VDC

# Skoll

## Perfil / Profil / Profilé / Perfis

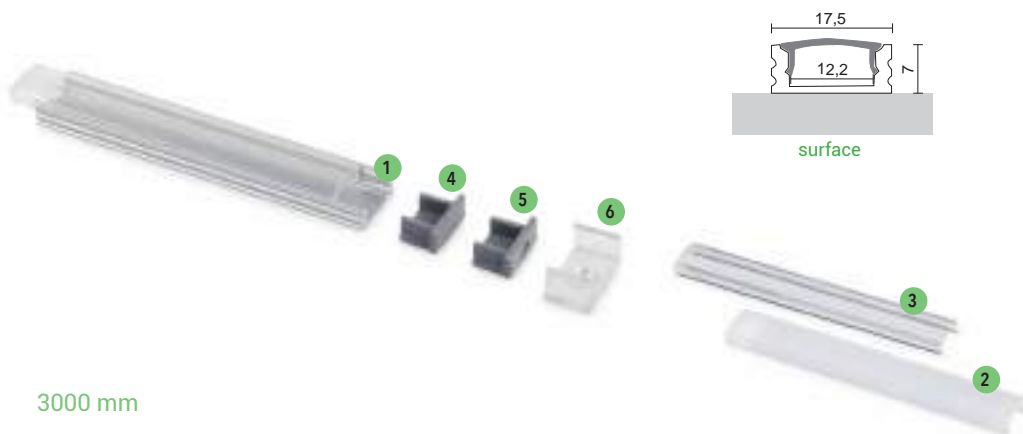

3000 mm

Ref.

ALU	1	A50A-778-39	Perfil aluminio anodizado en "U" 7x17,5 mm adosado (3m) 7x17,5mm "U"-shaped surface anodized aluminium profile (3m) Profil en aluminium anodisé dans "U" 7x17,5 mm sur surface (3m) Perfil alumínio anodizado em "U" 7x17,5 mm de superfície (3m)
PC OPAL	2	A50C-778-00	Difusor PC opal (3m) Opal PC diffuser (3m) Diffuseur PC opale (3m) Difusor PC opalino (3m)
PC TRANS	3	A50D-778-00	Difusor PC transparente (3m) Clear PC diffuser (3m) Diffuseur PC transparent (3m) Difusor PC transparente (3m)
	4	A50G-778-03	Tapa final gris sin agujero Grey end cap w/o hole Embout sans trou en gris Tampa final cinzenta sem furo
	5	A50H-778-03	Tapa final gris con agujero Grey end cap with hole Embout avec trou en gris Tampa final cinzenta com furo
	6	A50I-778-00	Fijación transparente Clear clamp Fixation transparente Fixação transparente

kit 1000 mm

Ref.

ALU		A50B-778-39	Perfil aluminio anodizado en "U" 7x17,5 mm adosado (1m)+ tapas+fijaciones 7x17,5mm "U"-shaped surface anodized aluminium profile (1m)+end caps+clamps Profil en aluminium anodisé dans "U" 7x17,5 mm sur surface (1m)+embouts+fixations Perfil alumínio anodizado em "U" 7x17,5 mm de superfície (1m) + tampas + fixações	
ALU	+	PC OPAL	A50E-778-39	Perfil aluminio anodizado en "U" 7x17,5 mm adosado (1 m)+difusor PC opal+ tapas+fijaciones 7x17,5mm "U"-shaped surface anodized aluminium profile (1m)+ opal PC diffuser+end caps+clamps Profil en aluminium anodisé dans "U" 7x17,5 mm sur surface (1m)+diffuseur PC opale +embouts+fixations Perfil alumínio anodizado em "U" 7x17,5 mm de superfície (1m) + difusor PC opal + tampas + fixações
ALU	+	PC OPAL	A50F-778-39	Perfil aluminio anodizado en "U" 7x17,5 mm adosado (1m)+difusor PC transparente+ tapas+fijaciones 7x17,5mm "U"-shaped surface anodized aluminium profile (1m)+clear PC diffuser+end caps+clamps Profil en aluminium anodisé dans "U" 7x17,5 mm sur surface (1m)+diffuseur PC transparent +embouts+fixations Perfil alumínio anodizado em "U" 7x17,5 mm de superfície (1m) + difusor de PC transparente + tampas + fixações

# Skoll

## Perfil / Profil / Profilé / Perfis

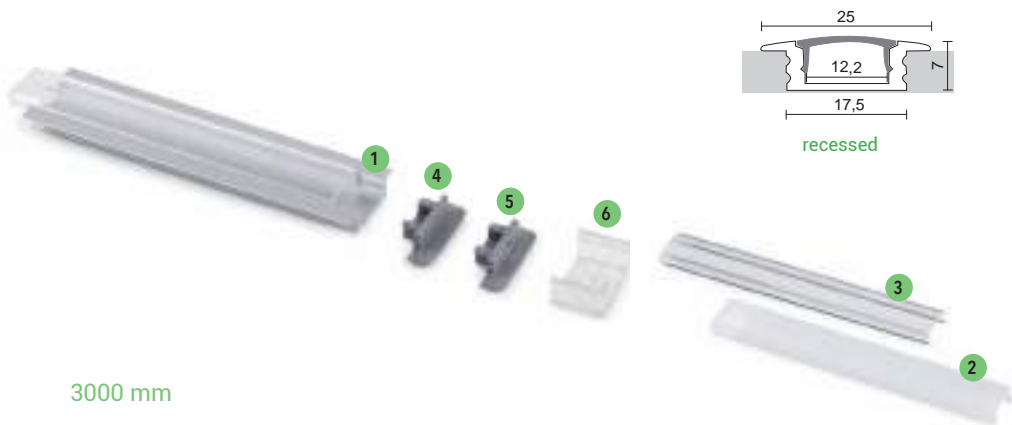

3000 mm

Ref.

ALU	1	A51A-778-39	Perfil aluminio anodizado empotrado 7x25 mm (3m) 7x25 mm recessed anodized aluminium profile (3m) Profil en aluminium anodisé encastré 7x25 mm (3m) Perfil alumínio anodizado de encastrar 7x25 mm (3m)
PC OPAL	2	A51C-778-00	Difusor PC opal (3m) Opal PC diffuser (3m) Diffuseur PC opale (3m) Difusor PC opalino (3m)
PC TRANS	3	A51D-778-00	Difusor PC transparente (3m) Clear PC diffuser (3m) Diffuseur PC transparent (3m) Difusor de PC transparente (3m)
	4	A51G-778-03	Tapa final gris sin agujero Grey end cap w/o hole Embout sans trou en gris Tampa final cinza sem furo
	5	A51H-778-03	Tapa final gris con agujero Grey end cap with hole Embout avec trou en gris Tampa final cinza com furo
	6	A51I-778-00	Fijación transparente Clear clamp Fixation transparente Fixação transparente

kit 1000 mm

Ref.

ALU		A51B-778-39	Perfil aluminio anodizado empotrado 7x25 mm (1m)+ tapas+fijaciones 7x25 mm recessed anodized aluminium profile (1m)+end caps+clamps Profil en aluminium anodisé encastré 7x25 mm (1m)+embouts+fixations Perfil alumínio anodizado de encastrar 7x25 mm (1m) + tampas + fixações	
ALU	+	PC OPAL	A51E-778-39	Perfil aluminio anodizado empotrado 7x25 mm (1m)+difusor PC opal+ tapas+fijaciones 7x25 mm recessed anodized aluminium profile (1m)+opal PC diffuser+end caps+clamps Profil en aluminium anodisé encastré 7x25 mm (1m)+diffuseur PC opale +embouts+fixations Perfil alumínio anodizado de encastrar 7x25 mm (1m) + difusor PC opal + tampas + fixações
ALU	+	PC TRANS	A51F-778-39	Perfil aluminio anodizado empotrado 7x25 mm (1m)+difusor PC transparente+ tapas+fijaciones 7x25 mm recessed anodized aluminium profile (1m)+clear PC diffuser+end caps+clamps Profil en aluminium anodisé encastré 7x25 mm (1m)+diffuseur PC transparent +embouts+fixations Perfil alumínio anodizado de encastrar 7x25 mm (1m) + difusor de PC transparente + tampas + fixações

# Skoll

## Perfil / Profil / Profilé / Perfis

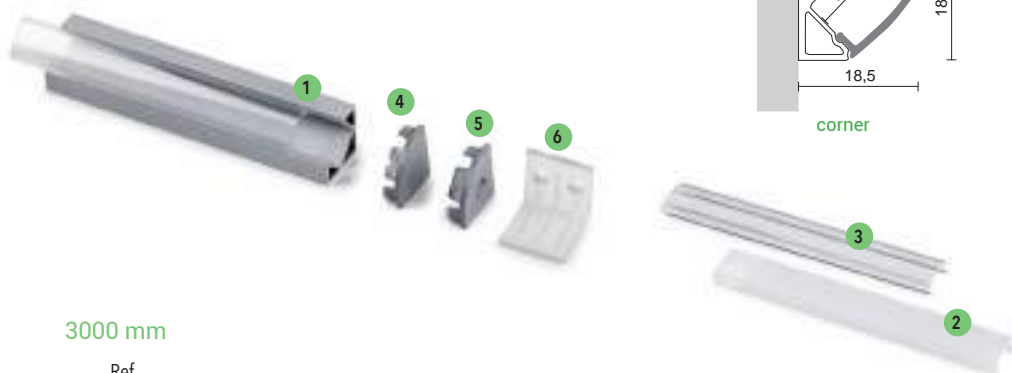

3000 mm

Ref.

ALU	1	A52A-778-39	Perfil aluminio anodizado esquinero 18,5x18,5 mm (3m) 18,5x18,5 mm anodized aluminium corner profile (3m) Profil en aluminium anodisé pour coin 18,5x18,5mm (3m) Perfil aluminio anodizado de canto 18,5x18,5mm (3m)
PC OPAL	2	A52C-778-00	Difusor PC opal (3m) Opal PC diffuser (3m) Diffuseur PC opale (3m) Difusor PC opalino (3m)
PC TRANS	3	A52D-778-00	Difusor PC transparente (3m) Clear PC diffuser (3m) Diffuseur PC transparent (3m) Difusor PC Transparente (3m)
	4	A52G-778-03	Tapa final gris sin agujero Grey end cap w/o hole Embout sans trou en gris Tampa final cinzenta sem furo
	5	A52H-778-03	Tapa final gris con agujero Grey end cap with hole Embout avec trou en gris Tampa final cinzenta com furo
	6	A52I-778-00	Fijación transparente Clear clamp Fixation transparente Fixação transparente

kit 1000 mm

Ref.

ALU		A52B-778-39	Perfil aluminio anodizado esquinero 18,5x18,5 mm (1m)+ tapas+fijaciones 18,5x18,5 mm anodized aluminium corner profile (1m)+end caps+clamps Profil en aluminium anodisé pour coin 18,5x18,5 mm(1m)+embouts+fixations Perfil aluminio anodizado de canto 18,5x18,5mm (1m)+tampas+fixações
ALU + PC OPAL		A52E-778-39	Perfil aluminio anodizado esquinero 18,5x18,5 mm (1m)+difusor PC opal+ tapas+fijaciones 18,5x18,5 mm anodized aluminium corner profile (1m)+opal PC diffuser+end caps+clamps Profil en aluminium anodisé pour coin 18,5x18,5 mm (1m)+diffuseur PC opale +embouts+fixations Perfil aluminio anodizado de canto 18,5x18,5mm (1m)+Difusor PC opalino (1m)+tampas+fixações
ALU + PC TRANS		A52F-778-39	Perfil aluminio anodizado esquinero 18,5x18,5 mm (1m)+difusor PC transparente+ tapas+fijaciones 18,5x18,5 mm anodized aluminium corner profile (1m)+clear PC diffuser+end caps+clamps Profil en aluminium anodisé pour coin 18,5x18,5 mm (1m)+diffuseur PC transparent +embouts+fixations Perfil aluminio anodizado de canto 18,5x18,5mm (1m)+Difusor PC transparente (1m)+tampas+fixações



# Led T2



**378A-L3103A-01**  
GX53 LED T2 3W 350lm

3000K

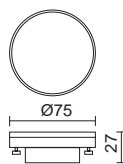

**378A-L3103A-02**  
GX53 LED T2 3W 350lm

4000K

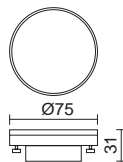

**378A-L3104A-01**  
GX53 LED T2 4W 320lm 3000K

3000K

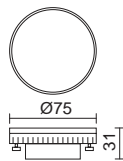

**378A-L3106A-01**  
GX53 LED T2 6W 480lm

3000K

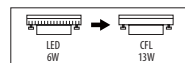
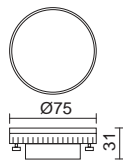

**378A-L3106A-02**  
GX53 LED T2 6W 480lm

4000K

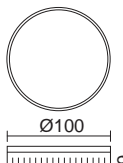

**378B-L3107A-01**  
GX53 LED T2 7W 800lm

3000K

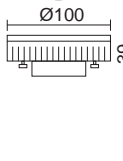

**378B-L3107A-02**  
GX53 LED T2 7W 700lm

4000K

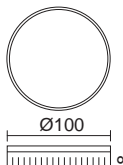

**378B-L3110A-01**  
GX53 LED T2 10W 1200lm

3000K

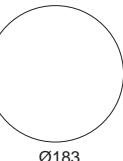

**378B-L3110A-02**  
GX53 LED T2 10W 1000lm

4000K

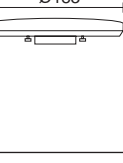

**378C-L3111A-01**  
GX53 LED T2 11W 1300lm

3000K



**378C-L3111A-02**  
GX53 LED T2 11W 900lm

4000K

# Led filament



632C-L0504B-01

E27 LED 4W 470lm 2700K

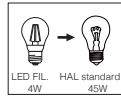

632C-L0506B-01

2700K 5 €

632C-L0506B-02

4000K 5 €

E27 LED 6W 800lm

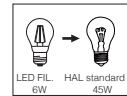
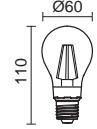

632F-L0504B-01

E27 LED 4W 470lm 2700K

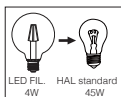
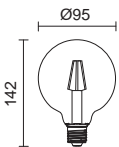

632G-L0504B-01

E27 LED 4W 470lm 2700K

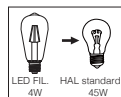
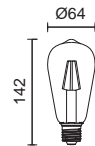

632H-L0504B-01

E27 LED 4W 470lm 3000K

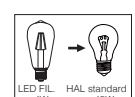
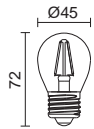

632D-L0404B-01

E14 LED 4W 470lm 2700K

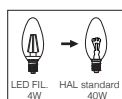
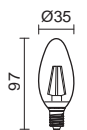

632E-L0404B-01

E14 LED 4W 470lm 2700K

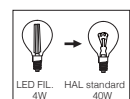
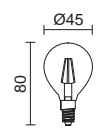

# Led pro



578A-L2104A-01 3000K  
578A-L2104A-02 4000K

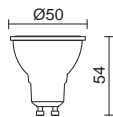

GU10 LED 3,5W 400lm



578A-L2105A-01 3000K  
578A-L2105A-02 4000K

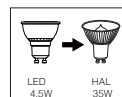
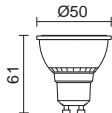

GU10 LED 4,5W 300lm



369C-L2308D-01 3000K  
369C-L2308D-02 4000K



368C-L2305D-01 3000K  
GU5,3 LED 4W 300lm

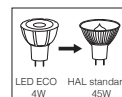
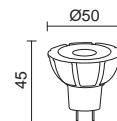
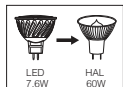
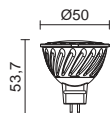

GU5,3 LED 7,6W 550lm

# G9



369D-L2003B-01  
G9 LED 2,5W 160lm 3000K

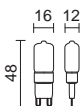

369D-L2003B-02  
G9 LED 2,5W 160lm 4000K

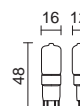

# Led modul



371A-L3309B-01  
LED SMD 8,7W 780lm 2900-3200K

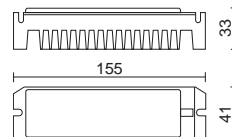
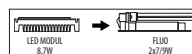

# Conectores / Connectors / Connecteurs / Conectores

IP 68



**B03A-X33X2A-02**

Doble conector para cables-manguera entre Ø 5 y 13 mm.  
 Double connector for wires-hoses between Ø 5 and 13 mm.  
 Double connecteur pour les câble multifils entre Ø 5 et 13 mm.  
 Duplo conector para cabos multifilares com Ø 5 e 13 mm.



**B03B-X33X2A-02**

Triple conector para cables-manguera entre Ø 5 y 13 mm.  
 Triple connector for wires-hoses between Ø 5 and 13 mm.  
 Triple connecteur pour les câble multifils entre Ø 5 et 13 mm.  
 Triplo conector para cabos multifilares com Ø 5 e 13 mm.

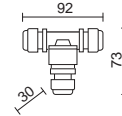

**B03C-X33X2A-02**

Triple conector para cables-manguera de Ø 13,5 mm.  
 Triple connector for wires-hoses between, Ø 13,5 mm.  
 Triple connecteur pour les câbles-tuyaux de Ø 13,5 mm.  
 Triplo conector para cabos multifilares, Ø 13,5 mm.

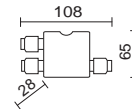

**B03D-X33X2A-02**

Triple conector para cables-manguera de Ø 13,5 mm.  
 Triple connector for wires-hoses between, Ø 13,5 mm.  
 Triple connecteur pour les câbles-tuyaux de Ø 13,5 mm.  
 Triplo conector para cabos multifilares, Ø 13,5 mm.

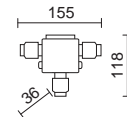

## Detector de presencia / Presence detector Détecteur de présence / Detetor de presença



IP 54 220V 240V AC

B04A-X33X2B-01   
 B04A-X33X2B-02

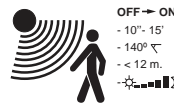

OFF → ON  
 - 10° - 15°  
 - 140°  
 - < 12 m.  
 - ☀️  
 - 🔦  
 - 🔦 1000W max.  
 - 🔦 500 max.

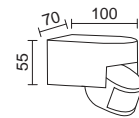

## Sensor crepuscular / Dusk-down sensor Senseur crépusculaire / Sensor crepuscular



B04B-X33X2B-01   
 B04B-X33X2B-02

IP 54 220V 240V AC

OFF → ON  
 - > 2 Lux < 1000 Lux  
 - ☀️  
 - 🔦  
 - 🔦 1000W max.  
 - 🔦 500 max.

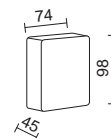

# Himmel



583A-L0140B-01

LED SMD 40W 3250lm 3000K

583A-L0240B-01

LED SMD 40W 3600lm 4000K

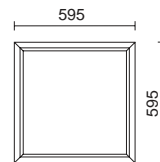

- Para falso techo modular.
- For modular ceiling.
- Pour faux plafond.
- Instalação em gesso cartonado.

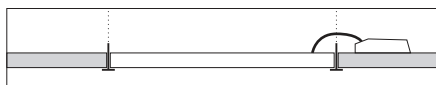

Accesorio superficie / Surface accessory  
 Accessoire surface / Acessório de superfície

605x605 A20B-583-01

±50



# Gia

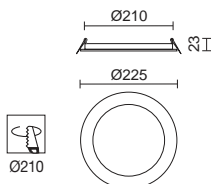

599A-L0118B-01

LED SMD 18W 1250lm 3000K

599A-L0218B-01

LED SMD 18W 1310lm 4000K

599A-L0318B-01

LED SMD 18W 1310lm 6000K

599A-L0124B-01

LED SMD 24W 1700lm 3000K

599A-L0224B-01

LED SMD 24W 1700lm 4000K

Kit de suspensión / Suspension kit  
 Kit du suspension / Kit de suspenção

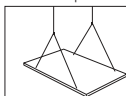

A20B-583-38

H max. 140cm









# Carril

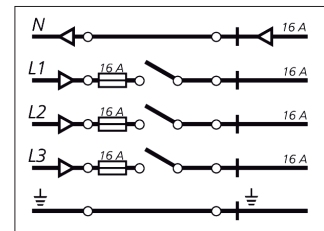
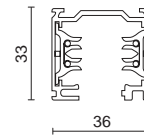

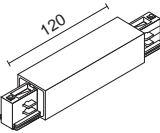
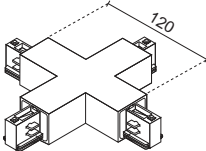
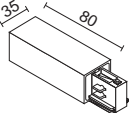
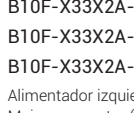
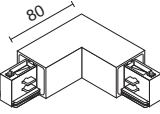
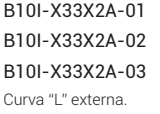
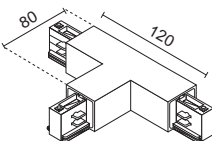
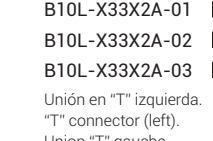
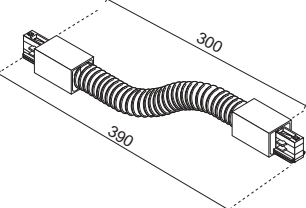

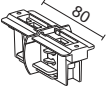

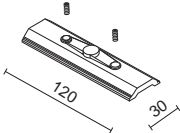
B10A-X33X2A-01	<input type="checkbox"/>	100 cm
B10A-X33X2A-02	<input checked="" type="checkbox"/>	100 cm
B10A-X33X2A-03	<input type="checkbox"/>	100 cm
B10B-X33X2A-01	<input type="checkbox"/>	200 cm
B10B-X33X2A-02	<input checked="" type="checkbox"/>	200 cm
B10B-X33X2A-03	<input type="checkbox"/>	200 cm
B10C-X33X2A-01	<input type="checkbox"/>	300 cm
B10C-X33X2A-02	<input checked="" type="checkbox"/>	300 cm
B10C-X33X2A-03	<input type="checkbox"/>	300 cm
B10D-X33X2A-01	<input type="checkbox"/>	400 cm
B10D-X33X2A-02	<input checked="" type="checkbox"/>	400 cm
B10D-X33X2A-03	<input type="checkbox"/>	400 cm

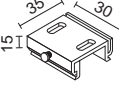
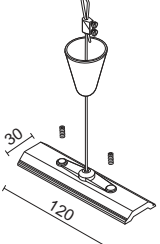
Carril / Track / Rail / Calha











 <p><b>B10G-X33X2A-01</b> <input type="checkbox"/>  <b>B10G-X33X2A-02</b> <input checked="" type="checkbox"/>  <b>B10G-X33X2A-03</b> <input type="checkbox"/>  Alimentador central.  Central power supply.  Alimentation centrale.  Alimentador central.</p>	 <p><b>B10J-X33X2A-01</b> <input type="checkbox"/>  <b>B10J-X33X2A-02</b> <input checked="" type="checkbox"/>  <b>B10J-X33X2A-03</b> <input type="checkbox"/>  Unión en "X".  "X" connector.  Union "X".  Junção "X".</p>	
 <p><b>B10E-X33X2A-01</b> <input type="checkbox"/>  <b>B10E-X33X2A-02</b> <input checked="" type="checkbox"/>  <b>B10E-X33X2A-03</b> <input type="checkbox"/>  Alimentador derecha.  Mains connector (right).  Alimentation droite.  Alimentador direito.</p>	 <p><b>B10F-X33X2A-01</b> <input type="checkbox"/>  <b>B10F-X33X2A-02</b> <input checked="" type="checkbox"/>  <b>B10F-X33X2A-03</b> <input type="checkbox"/>  Alimentador izquierda.  Mains connector (left).  Alimentation gauche.  Alimentador esquerda.</p>	
 <p><b>B10H-X33X2A-01</b> <input type="checkbox"/>  <b>B10H-X33X2A-02</b> <input checked="" type="checkbox"/>  <b>B10H-X33X2A-03</b> <input type="checkbox"/>  Curva "L" interna.  Internal "L" connector.  Curve "L" interne.  Curva "L" interior.</p>	 <p><b>B10I-X33X2A-01</b> <input type="checkbox"/>  <b>B10I-X33X2A-02</b> <input checked="" type="checkbox"/>  <b>B10I-X33X2A-03</b> <input type="checkbox"/>  Curva "L" externa.  External "L" connector.  Curve "L" externe.  Curva "L" exterior.</p>	
 <p><b>B10K-X33X2A-01</b> <input type="checkbox"/>  <b>B10K-X33X2A-02</b> <input checked="" type="checkbox"/>  <b>B10K-X33X2A-03</b> <input type="checkbox"/>  Unión en "T" derecha.  "T" connector (right).  Union "T" droit.  Junção "T" direito.</p>	 <p><b>B10L-X33X2A-01</b> <input type="checkbox"/>  <b>B10L-X33X2A-02</b> <input checked="" type="checkbox"/>  <b>B10L-X33X2A-03</b> <input type="checkbox"/>  Unión en "T" izquierda.  "T" connector (left).  Union "T" gauche.  Junção "T" esquerda esquerda.</p>	
 <p><b>B10N-X33X2A-01</b> <input type="checkbox"/>  <b>B10N-X33X2A-02</b> <input checked="" type="checkbox"/>  <b>B10N-X33X2A-03</b> <input type="checkbox"/>  Unión flexible.  Flexible coupling.  Union flexible.  Junção flexível.</p>	 <p><b>A17E-322-01</b> <input type="checkbox"/>  <b>A17E-322-02</b> <input checked="" type="checkbox"/>  <b>A17E-322-03</b> <input type="checkbox"/>  Tapa cierre.  End cap.  Fermeture couvercle.  Topo encerramento.</p>	
 <p><b>B100-X33X2A-01</b> <input type="checkbox"/>  <b>B100-X33X2A-02</b> <input checked="" type="checkbox"/>  Unión con contacto.  Connection with contact.  Union avec contact.  Junção com contato.</p>	 <p><b>A17C-322-01</b> <input type="checkbox"/>  <b>A17C-322-02</b> <input checked="" type="checkbox"/>  Unión sin contacto.  Connection without contact.  Union sans contact.  Junção sem contato.</p>	
 <p><b>A17A-322-03</b> <input type="checkbox"/>  Junta railes.  Mains supply.  Assemblage de rails.  Junta de calhas trifásicas.</p>	 <p><b>B10P-X33X2A-01</b> <input type="checkbox"/>  <b>B10P-X33X2A-02</b> <input checked="" type="checkbox"/>  <b>B10P-X33X2A-03</b> <input type="checkbox"/>  Adaptador carril electromecánico 6A (10Kg)  Electro/mechanical adapter 6A (10Kg)  Adaptateur rail électromécanique 6A (10Kg)  Adaptador electromecánico 6A (10Kg)</p>	 <p><b>A17B-322-01</b> <input type="checkbox"/>  Fijación a techo.  Ceiling connection.  Montage sur plafond.  Fixação ao tecto.</p>
 <p><b>A17D-322-01</b> <input type="checkbox"/>  <b>A17D-322-02</b> <input checked="" type="checkbox"/>  Kit de suspensión 2 m.  Suspension with mains supply 2m.  Kit suspension 2m.  Kit suspensão 2m.</p>		

## ALIMENTADORES / POWER SUPPLIES / ALIMENTATEURS / ALIMENTADORES

	REF.	OUT				IN		SIZES	IP
		V	C	220-240V	110-127V	V	Freq.		
	B02A-X3317H-01	-	350 mA DC	0-17W	0-12W	110-240 V AC	50/60 Hz	122x38x28	20
	B02A-X3320I-01	-	500 mA DC	0-20W	0-12W	110-240 V AC	50/60 Hz	120x40x20	20
	B02G-X3306J-01	-	700 mA DC	6W	-	100-240 V AC	50/60 Hz	58x40x20	20
	B02A-X3317J-01	-	700 mA DC	0-17W	0-12W	110-240 V AC	50/60 Hz	122x38x28	20
	B02N-X3320M-01	-	1050 mA DC	20W	-	220-240 V AC	50/60 Hz	32x28x112	20

12V  
AC

	REF.	OUT				IN		SIZES	IP
		V	C	220-240V	110-127V	V	Freq.		
	B02J-X3350D-02	12 V AC	-	50W	-	220-240 V AC	50/60 Hz	80x78x60	65
	B02B-X3360B-01	12 V AC	-	60W	-	220-240 V AC	50/60 Hz	22x36x103	20
	B02B-X33A2B-01	12 V AC	-	105W	-	230-240 V AC	50/60 Hz	33x37x128	20
	B02B-X33A4B-01	12 V AC	-	150W	-	230-240 V AC	50/60 Hz	33x37x185	20
	B02M-X33A5D-03	12 V AC	-	200W	-	230 V AC	50/60 Hz	108x104x99	20
	B02C-X33A7D-02	12 V AC	-	300W	-	230 V AC	50 Hz	120x140	66
	B02I-X33F9D-02	12 V AC	-	350W	-	220-240 V AC	50/60 Hz	175x155x110	65
	B02F-X33A8D-32	12 V AC	-	400W	-	230 V AC	50 Hz	220x110	20
	B02M-X33A9D-03	12 V AC	-	500W	-	230 V AC	50/60 Hz	120x132x108	20
	B02I-X33G1D-02	12 V AC	-	700W	-	220-240 V AC	50/60 Hz	175x175x110	65



## ALIMENTADORES / POWER SUPPLIES / ALIMENTATEURS / ALIMENTADORES

24V  
DC

	REF.	OUT				IN		SIZES	IP
		V	C	220-240V	110-127V	V	Freq.		
	B02A-X33X2F-01	24 V DC	-	15W	-	200-240 V AC	50/60 Hz	111'5x44x19'1	20
	B02Q-X3312F-01	24 V DC	-	12W	12W	90-295 V AC	50/60 Hz	77x40x29	30
	B02Q-X3325F-01	24 V DC	-	25W	25W	90-295 V AC	50/60 Hz	84x57x29	30
	B02V-X3335F-00	24 V DC	-	35W	35W	220-240 V AC	50/60 Hz	220x40x21	20
	B02O-X3340F-39	24 V DC	-	40W	40W	90-305 V AC	50/60 Hz	171x61x37	65
	B02V-X3360F-00	24 V DC	-	60W	60W	220-240 V AC	50/60 Hz	250x40x21	20
	B02W-X3360F-00	24 V DC	-	60W	60W	220-240 V AC	50/60 Hz	206x51x36	20
	B02Y-X3360F-00	24 V DC	-	75W	75W	220-240 V AC	50/60 Hz	180x49x32	67
	B02O-X3380F-39	24 V DC	-	80W	80W	90-305 V AC	50/60 Hz	196x51x39	65
	B02V-X3396F-00	24 V DC	-	96W	96W	220-240 V AC	50/60 Hz	300x44x23	20
	B02R-X33A1F-01	24 V DC	-	100W	100W	90-295 V AC	50/60 Hz	190x52x37	30
	B02O-X33A1F-39	24 V DC	-	100W	100W	90-305 V AC	50/60 Hz	220x68x39	65
	B02Y-X33A1F-00	24 V DC	-	100W	100W	220-240 V AC	50/60 Hz	206x68,6x37	67
	B02V-X33A4F-00	24 V DC	-	150W	150W	220-240 V AC	50/60 Hz	270x63x40,5	20
	B02O-X33A4F-39	24 V DC	-	150W	150W	90-295 V AC	50/60 Hz	220x68x39	67
	B02Y-X33A4F-00	24 V DC	-	150W	150W	220-240 V AC	50/60 Hz	206x68,6x37	67



# Acabados y Pictografía

Finishes and simbology

Finitions et pictographie

Acabamentos e pictografia



## Proyectos especiales para pantallas

En Grupo Novolux queremos darle el mejor servicio, por ello le ofrecemos la posibilidad de que las luminarias que Ud elija puedan vestirse con las pantallas que mejor le sienten a su proyecto, a ese espacio diseñado en armonía de formas y colores.

Le ofrecemos diferentes colores y texturas para imprimir la personalidad e imagen que usted desee proyectar.

LLámenos y consulte disponibilidad, bajo pedido podemos poner a su disposición muchas combinaciones.

## Special projects for shades

The aim of Grupo Novolux is to provide you the best possible service, so we offer you the possibility to choose the shades for the lighting fixtures to better suit your project and to achieve a space designed in harmony of shapes and colors.

We propose different colors and textures to print the personality and image you want to project.

Contact us and check availability, upon request we can put at your disposal different combinations.

## Solutions spéciales pour vos abat-jours

Toujours soucieux de vous offrir le meilleur service, grupo novolux vous propose une large sélection d'abat-jours pour habiller les luminaires que vous sélectionnez et les intégrer dans votre projet, dans cet espace que vous avez créé en harmonie en harmonie de formes et de couleurs.

Un grand choix de coloris et textures vous est proposé pour refléter la personnalité et l'image que vous souhaitez transmettre.

N'hésitez pas à nous solliciter pour consulter les disponibilités. Une large gamme de solutions est disponible sur commande.

## Projotos especiais para abajures

No Grupo Novolux queremos dar-lhe o melhor serviço, por isso oferecemos-lhe a possibilidade de que as luminarias que você escolha possam equipar-se com os Abajures que melhor fiquem no seu projeto, para que esse espaço esteja desenhado, concebido, em harmonia de formas e cores.

Oferecemos-lhe diferentes cores e texturas para imprimir a personalidade e imagem que você deseja projetar.

Contate-nos e consulte a disponibilidade, sob pedido podemos pôr à sua disposição muitas combinações.



▲  
 Acabados de pantalla bajo pedido  
 Shade finishes supplied under request  
 Finitions d'abat-jours sur demande  
 Acabamentos na tela bajo pedido

### Cotton



### Linen

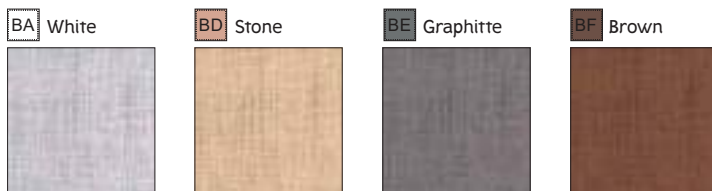

### Eco



### Yute



### Persia



### Damasco



### Synthetic

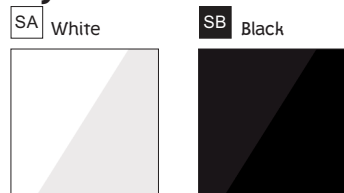

### Ribbon wrapped



# Acabados / Finishes / Finitions / Acabamentos

Los artículos de este catálogo se suministran según el modelo, con diferentes acabados. Estos vienen representados por las dos últimas cifras del código y un recuadro de color. El color en las fotografías de producto, es orientativo debido a las variaciones de las tonalidades que ocasiona el proceso de impresión.

The articles in this catalogue are supplied according to the model, with different finishes. These are represented by icons. Colours in the product photographs are purely orientative as variations in shades may be produced in the printing process.

Les produits de ce catalogue sont fournis d'après le modèle, avec des finitions différentes. Ceux-ci sont représentés par des icônes différentes. La couleur dans les images du produit est seulement indicative à cause des variations des teintes dues par le processus d'impression.

Os artigos deste catálogo são fornecidos segundo o modelo, com diferentes acabamentos. Estes são representados por diferentes ícones. A cor do produto nas fotografias é meramente indicativa devido às variações das tonalidades provocadas pelo processo de impressão.

01	Blanco / White / Blanc / Branco	34	Latón / Brass / Laiton / Latão	55	Fibra sintética plata Synthetic silver fiber Fibre synthétique argent Fibra Sintética Prata
02	Negro / Black / Noir / Preto	35	Níquel satinado / Satin nickel Nickel satiné / Níquel acetinado	56	Fibra sintética oro Synthetic gold fiber Fibre synthétique or Fibra Sintética Ouro
03	Gris / Grey / Gris / Cinzento	36	Latón cromo / Chrome brass Laiton chrom / Latão cromo	60	Piedra Leccese / Leccese stone Pierre Leccese / Pedra Leccese
04	Antracita / Anthracite Anthracite / Antracite	37	Cobre / Copper / Cuivre / Cobre	61	Piedra Leccese Antracita Leccese anthracite stone Pierre Leccese Anthracite Pedra Leccese
05	Verde / Green / Verd / Verde	38	Acero cincado / Zinc-plated Steel Acier zingué / Aço zincado	62	Piedra Leccese marrón / Leccese brown stone Pierre Leccese brun / Pedra Leccese brown
07	Rojo / Red / Rouge / Vermelho	39	Aluminio anodizado / Anodized aluminum Aluminium anodisé / Aluminio anodizado	63	Piedra Leccese rosso mattone Leccese rosso mattone stone Pierre Leccese rosso mattone Pedra Leccese rosso mattone
09	Beige / Beige / Beige / Bege	40	Aluminio cepillado / Brushed aluminum Aluminium brossé / Aluminio cepillado	64	Piedra Crema / Cream stone Pierre Crème / Pedra Creme
10	Gris envejecido / Antique grey Gris vieilli / Cinzento velho	41	Acero Galvanizado / Galvanized Steel Acier galvanisé / Aço galvanizado	65	Piedra Ardesia / Ardesia stone Pierre Ardesia / Pedra Ardesia
11	Marfil / Ivory / Ivoire / marfim	42	Burdões cepillado / Brushed Burgundy Bordeaux brossé / Bordeaux cepillado	71	Piedra Lavica / Lavica stone Pierre Lavica / Pedra Lavica
12	Marrón oscuro / Dark brown Marron foncé / Marrom escuro	43	Inox cepillado / Brushed stainless steel Inox brossé / Inox cepillado	74	Marmol Travertino / Travertino marble Marbre Travertino / Mármore Travertino
13	Gris piedra / Stone grey Gris pierre / Pedra cinzenta	44	Plata / Silver / Argenti / Prata	75	Marmol de Carrara / Carrara marble Marbre de Carrara / Mármore do Carrara
28	Matizado / Frosted / Mat / Fosco	46	Oro mate / Matt gold Or mat / Matt ouro	90	Marrón óxido / Oxide brown Roville / Marrom óxido
29	Transparente / Transparent Transparent / Transparente	50	Madera Haya / Beech Wood Bois hêtre / Madeira faia	91	Marrón cobrizo / Copper brown Brune cuivre / Marrom cobre
30	Inox / Stainless steel Acier inoxydable / Aço inox	51	Madera Roble / Oak Wood Bois chêne / Madeira Carvalho	92	Cristal transparente / Transparent glass Verre transparent / Vidro transparente
31	Inox pulido / Brushed stainless steel Inox poli / Inox polido	52	Madera Cerezo / Cherry Wood Bois de cerisier / Madeira Cerejeira	94	Pan de oro / Gold leaf Feuille d'or / Pão de Ouro
32	Cromo / Chrome / Chrom / Cromo	53	Fibra natural beige / Natural beige fiber Fibre naturelle beige / Fibra Natural Beige	95	Pan de plata / Silver leaf Feuille d'argent / Pão de Prata
33	Latón envejecido / Antique brass Laiton vieilli / Latão antigo	54	Fibra natural marrón Natural brown fiber Fibre naturelle marron Fibra Natural Castanho		

# Materiales / Materials / Matériaux / Materiais



Cuerpo / Body / Corps / Corpo



Marco / Frame / Marc / Aro





























Difusor / Diffusor / Diffuseur / Difusor











Aspa / Blade / Lame / Pala





























ABS	Plástico ABS	ABS plastic	Plastique ABS	Plástico ABS
ACER	Acero	Steel	Acier	Aço
ALU	Aluminio	Aluminium	Aluminium	Aluminio
ALU ANOD	Aluminio anodizado	Anodized aluminum	Aluminium anodisé	Aluminio anodizado
BRASS	Latón	Brass	Laiton	Latão
COTTON	Algodón	Cotton	Coton	Algodão
CONCR	Hormigón	Concrete	Béton	Concreto
Cu	Cobre	Copper	Cuivre	Cobre
GLASS	Cristal	Glass	Verre	Vidro
GLASS AMBER	Cristal ambar	Amber glass	Verre ambre	Vidro ambar
GLASS MAT	Cristal matizado	Frosted glass	Verre teinté	Vidro fosco
GLASS OPAL	Cristal opalizado	Opal glass	Verre opale	Vidro opalino
GLASS PRISM	Cristal prismático	Prismatic glass	Verre prismatique	Vidro prismático
GLASS TRANS	Cristal transparente	Transparent glass	Verre transparent	Vidro transparente
INOX	Acero inoxidable	Stainless steel	Acier inoxydable	Aço inoxidável
NAT FIBER	Fibra natural	Natural fiber	Fibre naturelle	Fibra natural
PA	Poliamida	Polyamide	Polyamide	Poliamida
PC	Policarbonato	Polycarbonate	Polycarbonate	Policarbonato
PC MAT	Policarbonato matizado	Frosted polycarbonate	Polycarbonate teinté	Policarbonato fosco
PC OPAL	Policarbonato opalizado	Opal polycarbonate	Polycarbonate opale	Policarbonato opalino
PC PRISM	Policarbonato prismático	Prismatic polycarbonate	Polycarbonate prismatique	Policarbonato prismático
PC TRANS	Policarbonato transparente	Transparent polycarbonate	Polycarbonate transparent	Policarbonato transparente
PE	Polietileno	Polyethylene	Polyéthylène	Polietileno
PLASTER	Yeso	Plaster	Plâtre	Gesso
PMMA	Metacrilato	Methacrylate	Méthacrylate	Metacrilato
PMMA MAT	Metacrilato matizado	Frosted methacrylate	Méthacrylate teinté	Metacrilato fosco
PMMA OPAL	Metacrilato opalizado	Opal methacrylate	Méthacrylate opale	Metacrilato opalino
PMMA PRISM	Metacrilato prismático	Prismatic methacrylate	Méthacrylate prismatique	Metacrilato prismático
PMMA TRANS	Metacrilato transparente	Transparent methacrylate	Méthacrylate transparent	Metacrilato transparente
PPH	Polipropileno homopolímero	Polypropylene homopolymer	Polypropylène homopolymère	Homopolímero de polipropileno
RESIN	Resina	Resin	Resine	Resina
RIBBON WRAPPED	Cinta envuelta	Ribbon wrapped	Ruban enveloppé	Fita envolvida
SILICON	Silicona	Silicone	Silicone	Silicone
STONE	Piedra	Stone	Pierre	Pedra
SYNT	Sintética	Syntetic	Synthétique	Sintética
SYNT FIBER	Fibra sintética	Syntetic fiber	Fibre synthétique	Fibra sintética
TECNO POLIM	Tecnopolímero	Technopolymer	Technopolymère	Tecnopolímero
TERMO PLASTIC	Termoplástico	Thermoplastic	Thermoplastique	Termoplástico
WOOD	Madera	Wood	Bois	Madeira

# Pictografía / Symbology / Symbologie / Pictografia

	Luminaria para superficie en pared.	Surface mounted wall luminaire.	Luminaire pour la surface du mur.	Luminária para parede, saliente.
	Luminaria para superficie en techo.	Surface mounted ceiling luminaire.	Luminaire pour la surface du plafond.	Luminária para teto, saliente.
	Luminaria para empotrar en pared.	Recessed wall luminaire.	Luminaire pour encastrer sur le mur.	Luminária para parede, encastrável.
	Luminaria para empotrar en techo.	Recessed ceiling luminaire.	Luminaire pour encastrer sur le plafond.	Luminária para teto, encastrável.
	Luminaria para empotrar en suelo.	Recessed floor luminaire.	Luminaire encastré par sol.	Luminária para pavimento, encastrável.
	Luminaria de baliza o sobremuro.	Bollard or wall-top luminaire.	Borne ou sur mur.	Luminária elemento balizador ou de muro.
	Proyector de pared.	Spotlight-type surface for wall.	Projecteur pour la surface du mur.	Projektor para parede.
	Proyector de suelo.	Spotlight-type surface for floor.	Projecteur du sol.	Projektor para pavimento.
	Luminaria con piqueta.	Luminaire with spike.	Luminaire avec piquet.	Luminária com piquet.
	Luminaria con alimentación solar.	Solar powered luminaire.	Solaire luminaria alimenté.	Luminária com alimentação solar.
	Luminaria identificadas como clásico-residencial.	Luminaire classified as classical-residential.	Luminaire identifiée comme résidentiel-classique.	Luminária do tipo clássico-residencial.
	Luminaria de suspensión.	Pendant luminaire.	Luminaire de suspension.	Luminária de Suspensão.
	Luminaria vial tipo poste o columna.	Streetlighting post or column luminaire.	Luminaire à ampoule type poteau ou colonne.	Luminária pública do tipo com poste ou coluna.
	Luminaria sumergible.	Underwater lights.	Eclairage subaquatique.	Submersíveis.
	Iluminación decorativa.	Decorative Lighting.	Éclairage décorative.	Iluminação Decorativa.
	Luminaria de pie.	Floor lamps.	Eclairage de sol.	Luminária chão.
	Luminaria de sobremesa.	Table lamps.	Luminaire de bureau.	Luminária de escritórios.
	Ventiladores.	Ceiling fans.	Ventilateurs.	Fãs.
	Gama de productos complementarios a nuestros catálogos (lámparas, tiras led, alimentadores, conectores...)	Complementary range of products on catalogs (lamps, led strips, transformers, connectors...)	Gamme de produits en complément sur nos catalogues (lampes, rubans Led, alimentations, connecteurs...)	Gama de produtos complementares aos nossos catálogos (lâmpadas, fitas led, alimentadores, conectores...)
	Luminaria con tecnologiaLED.	Luminaire withLED technology.	Luminaire à technologieLED.	Luminária com tecnologiaLED.
	Novedad .	New.	Nouveauté.	Novidade.
	Ampliación de gama .	Product range enlargement.	Élargissement de gamme .	Extensão de gamma.
	Producto bajo pedido.	To order product.	Produit sur demande.	Produto a pedido.
	Clase I; Luminaria provista de dispositivos de toma-tierra.	Class I; luminaire fitted with earth-ground devices.	Clase I; Luminaire fourni de dispositifs prise de terre.	Clase I; luminária com dispositivos de ligação à terra.
	Clase II; Luminaria que aísla doblemente las partes con tensión y no precisa dispositivos de toma-tierra.	Class II; luminaire that doubly insulates the electrified parts and does not require an earth-ground device.	Clase II; Luminaire qui isole doublement les parties avec tension et n'a pas besoin de dispositifs de prise de terre.	Clase II; luminária que tem duplo isolamento das partes sob tensão e não precisa de dispositivos de ligação à terra.
	Clase III; Luminaria alimentada a muy baja tensión y que no debe tener dispositivos toma-tierra.	Class III; luminaire with very low voltage power supply which does not require earth-ground devices.	Clase III; Luminaire alimentée à très basse tension et ne doit surtout pas avoir des dispositifs de prise de terre.	Clase III; luminária alimentada com muito baixa tensão e que não deve ter dispositivos de ligação à terra.



<p><b>IP</b></p>	<p>Grado de protección IP Según la normativa EN 60598-1, las luminarias se clasifican en función de la protección derivada de sus elementos constructivos. Su nomenclatura se simboliza mediante las letras IP seguidas de tres cifras, aunque sólo se muestren las dos primeras.</p> <p>1ª cifra: Indica la protección del material frente a la filtración de elementos extraños y polvo, así como de las personas respecto a la tensión de los componentes de la luminaria.</p> <p>0-No protegida. 1-Protegida frente a cuerpos sólidos mayores de 50 mm. 2-Protegida frente a cuerpos sólidos mayores de 12 mm. 3-Protegida frente a cuerpos sólidos mayores de 2,50 mm. 4-Protegida frente a cuerpos sólidos mayores de 1 mm. 5-Protegida contra el polvo. 6-Completa protección contra el polvo.</p> <p>2ª cifra: Indica la protección del material a la penetración de líquido.</p> <p>0-No protegida. 1-Protegida a la caída vertical de gotas de agua. 2-Protegida frente a la caída de gotas hasta un alineación de 15° respecto a la vertical. 3-Protegida frente a la lluvia. 4-Protegida contra la proyección del agua. 5-Protegida al chorro de agua. 6-Protegida a los golpes de mar. 7-Protegida a la inmersión. 8-Material sumergible.</p>	<p>Degree of IP protection In accordance with standard EN 60598-1, luminaires are classified on the basis of the protection derived from their elements of construction. The degree of protection is indicated by the letters IP followed by a 3-figure number, though only the first two numbers are shown.</p> <p>1st figure: Indicates the protection of the material against the entry of foreign bodies and dust, as well of people coming into contact with live parts in the device.</p> <p>0-Not Protected. 1-Protected against foreign objects &gt; 50mm. 2-Protected against foreign objects &gt; 12mm 3-Protected against foreign objects &gt; 2.5mm. 4-Protected against foreign objects &gt; 1mm. 5-Dust-protected 6-Completely dust-tight</p> <p>2nd figure: Indicates the protection of the material against the entry of moisture.</p> <p>0-Not protected. 1-Protected against vertically falling drops of water. 2-Protected against water drops with the housing tilted at 15° with respect to the vertical. 3-Protected against rain. 4-Protected against splashing. 5-Protected against jets of water. 6-Protected against powerful water jets. 7-Protected against temporary immersion. 8-Submersible material.</p>	<p>Indice de protection IP Conformément à la norme EN 60598-1, les luminaires sont classés en fonction de la protection dérivée de leurs éléments constructifs. Leur nomenclature est symbolisée par les lettres IP suivies de trois chiffres, même si s'affichent uniquement les deux premiers.</p> <p>1er chiffre: Indique la protection du matériel par rapport à la filtration d'éléments étrangers et de poussière, ainsi que de personnes physiques, à l'égard de la tension des composants du luminaire.</p> <p>0-Aucune protection. 1-Protégé contre les corps solides supérieurs à 50 mm. 2-Protégé contre les corps solides supérieurs à 12 mm. 3-Protégé contre les corps solides supérieurs à 2,50 mm. 4-Protégé contre les corps solides supérieurs à 1 mm. 5-Protégé contre la poussière. 6-Protection complète contre la poussière.</p> <p>2ème chiffre: Indique la protection du matériel par rapport à la pénétration de liquide.</p> <p>0-Aucune protection. 1-Protégé contre les gouttes d'eau tombant verticalement. 2-Protection contre les gouttes tombant à un alignement de 15° avec la verticale. 3-Protégé contre la pluie. 4-Protégé contre les projections d'eau. 5-Protégé contre le jet d'eau. 6-Protégé contre les coups de mer. 7-Protégé contre l'immersion. 8-Matériau submersible.</p>	<p>Grau de proteção IP Nos termos da norma EN 60598-1, as luminárias são classificadas em função da proteção derivada dos seus elementos construídos. A sua nomenclatura é indicada pelas letras IP seguidas de três algarismos, embora só sejam mostrados os dois primeiros.</p> <p>1.º algarismo: indica a proteção do material relativamente à filtração de elementos estranhos e pó, assim como das pessoas relativamente à tensão dos componentes da luminária.</p> <p>0-Não protegida. 1-Protegida contra corpos sólidos maiores do que 50mm. 2-Protegida contra corpos sólidos maiores do que 12mm. 3-Protegida contra corpos sólidos maiores do que 2,5mm. 4-Protegida contra corpos sólidos maiores do que 1mm. 5-Protegida contra o pó. 6-Proteção completa contra o pó.</p> <p>2.º algarismo: Indica a proteção do material relativamente à penetração de líquidos.</p> <p>0-Não protegida. 1-Protegida contra a queda vertical de gotas de água. 2-Protegida contra a queda de gotas até a uma inclinação de 15° em relação à vertical. 3-Protegida contra chuva. 4-Protegida contra projeção de água. 5-Protegida contra jatos de água. 6-Protegida contra ondas do mar. 7-Protegida contra imersão. 8-Material submersível.</p>																																																																																
<p><b>IK</b></p>	<p>Código IK Sistema de codificación para indicar el grado de protección proporcionado por una envolvente contra los impactos mecánicos nocivos. Energía de impacto (J)</p> <table border="1" data-bbox="194 1172 435 1228"> <tr> <td>IK01</td><td>IK02</td><td>IK03</td><td>IK04</td><td>IK05</td><td>IK06</td><td>IK07</td><td>IK08</td><td>IK09</td><td>IK10</td> </tr> <tr> <td>0,15</td><td>0,2</td><td>0,35</td><td>0,5</td><td>0,7</td><td>1</td><td>2</td><td>5</td><td>10</td><td>20</td> </tr> </table>	IK01	IK02	IK03	IK04	IK05	IK06	IK07	IK08	IK09	IK10	0,15	0,2	0,35	0,5	0,7	1	2	5	10	20	<p>IK Code The IK code is an international numerical classification for the degree of protection provided by enclosures for electrical equipment against external mechanical impact. Impact energy (J).</p> <table border="1" data-bbox="454 1172 694 1228"> <tr> <td>IK01</td><td>IK02</td><td>IK03</td><td>IK04</td><td>IK05</td><td>IK06</td><td>IK07</td><td>IK08</td><td>IK09</td><td>IK10</td> </tr> <tr> <td>0,15</td><td>0,2</td><td>0,35</td><td>0,5</td><td>0,7</td><td>1</td><td>2</td><td>5</td><td>10</td><td>20</td> </tr> </table>	IK01	IK02	IK03	IK04	IK05	IK06	IK07	IK08	IK09	IK10	0,15	0,2	0,35	0,5	0,7	1	2	5	10	20	<p>Code IK Système de codification qui indique le degré de protection procuré par une enveloppante contre des impacts mécaniques nuisibles. Énergie d'impact (J)</p> <table border="1" data-bbox="713 1172 954 1228"> <tr> <td>IK01</td><td>IK02</td><td>IK03</td><td>IK04</td><td>IK05</td><td>IK06</td><td>IK07</td><td>IK08</td><td>IK09</td><td>IK10</td> </tr> <tr> <td>0,15</td><td>0,2</td><td>0,35</td><td>0,5</td><td>0,7</td><td>1</td><td>2</td><td>5</td><td>10</td><td>20</td> </tr> </table>	IK01	IK02	IK03	IK04	IK05	IK06	IK07	IK08	IK09	IK10	0,15	0,2	0,35	0,5	0,7	1	2	5	10	20	<p>Código IK Sistema de codificação para indicar o grau de proteção proporcionado por um invólucro contra impactos mecânicos nocivos. Energia de impacto (J).</p> <table border="1" data-bbox="963 1172 1204 1228"> <tr> <td>IK01</td><td>IK02</td><td>IK03</td><td>IK04</td><td>IK05</td><td>IK06</td><td>IK07</td><td>IK08</td><td>IK09</td><td>IK10</td> </tr> <tr> <td>0,15</td><td>0,2</td><td>0,35</td><td>0,5</td><td>0,7</td><td>1</td><td>2</td><td>5</td><td>10</td><td>20</td> </tr> </table>	IK01	IK02	IK03	IK04	IK05	IK06	IK07	IK08	IK09	IK10	0,15	0,2	0,35	0,5	0,7	1	2	5	10	20
IK01	IK02	IK03	IK04	IK05	IK06	IK07	IK08	IK09	IK10																																																																											
0,15	0,2	0,35	0,5	0,7	1	2	5	10	20																																																																											
IK01	IK02	IK03	IK04	IK05	IK06	IK07	IK08	IK09	IK10																																																																											
0,15	0,2	0,35	0,5	0,7	1	2	5	10	20																																																																											
IK01	IK02	IK03	IK04	IK05	IK06	IK07	IK08	IK09	IK10																																																																											
0,15	0,2	0,35	0,5	0,7	1	2	5	10	20																																																																											
IK01	IK02	IK03	IK04	IK05	IK06	IK07	IK08	IK09	IK10																																																																											
0,15	0,2	0,35	0,5	0,7	1	2	5	10	20																																																																											
	<p> Emisión de luz asimétrica.</p>	<p>Asymmetric light emission.</p>	<p>Émission de lumière asymétrique.</p>	<p>Emissão de luz assimétrica.</p>																																																																																
	<p>Ángulo de emisión de luz.</p>	<p>Light emission angle.</p>	<p>Angle d'émission de la lumière.</p>	<p>Ângulo de emissão de luz.</p>																																																																																
	<p>Emisión de luz directa o indirecta</p>	<p>Emission of direct or indirect light.</p>	<p>Émissions de lumière directe ou indirecte.</p>	<p>Emissão de luz direta ou indireta.</p>																																																																																
	<p>Emisión de luz directa y indirecta</p>	<p>Emission of direct and indirect light.</p>	<p>Émissions de lumière directe et indirecte.</p>	<p>Emissão de luz direta e indireta.</p>																																																																																
	<p>Multi-emisión de luz.</p>	<p>Multi-emission light.</p>	<p>Multi-émissions de lumière.</p>	<p>Multi-emissão de luz.</p>																																																																																
	<p>Emisión de luz periférica.</p>	<p>Periferic emission light.</p>	<p>Émission périphérique de lumière.</p>	<p>Emissão periférica de luz.</p>																																																																																
	<p>Longitud en metros de cable conductor suministrado.</p>	<p>Length in meters of the lead wire supplyd.</p>	<p>Longueur en mètres du câble conducteur fourni.</p>	<p>Comprimento em metros de cabo condutor fornecido.</p>																																																																																

	Corriente de la luminaria en corriente continua.	Luminaire current in direct current.	Courant de la lampe avec courant continu.	Corrente da luminária em corrente continua.
	Voltaje de la luminaria en corriente continua.	Luminaire voltage in direct current.	Tension de la lampe avec courant continu.	Tensão da luminária em corrente continua.
	Voltaje de la luminaria (Voltios), de corriente alterna.	Luminaire voltage (volts) in alternate current.	Tension de la lampe (Volts) avec courant alternatif.	Tensão da luminária (volts) em corrente alternada.
	Luminaria con sensor crepuscular y movimiento.	Luminaire with daylight and motion sensor.	Luminaire avec senseur crépusculaire et mouvement.	Luminária con sensor crepuscular e movimento.
	Luminaria con luz de emergencia.	Luminaire with emergency light.	Luminaire avec éclairage de secours.	Luminária con luz de emergência.
	Luminaria con dos salidas de cable.	Luminaire with two cable outlets.	Luminaire avec deux sorties de câble.	Luminária com duas saídas de cabo.
	Luminaria con conexión USB (5V max. 2A)	Luminaire with USB port (5V max. 2A)	Luminaire avec connexion USB (5V max. 2A)	Luminária com ligação USB (5V max. 2A)
	Luminaria con cable clavija incorporada.	Lighting with plug-electrical wire Included.	Luminaire avec câble d'alimentation et fiche Inclus.	Luminária com cabo e ficha Incorporada.
	Luminaria con toma corriente IP44	Luminaire with IP44 plug.	Luminaire avec prise courant électrique IP44.	Luminária con plugue IP44.
	Luminaria con interruptor Incorporado.	Lighting with switch Included.	Luminaire avec interrupteur Inclus.	Luminária com interruptor Incorporado.
	Equipo Incluido.	Luminaire with equipment Included.	Luminaire avec équipement Inclus.	Luminaire com aparelhagem Incluido.
	Equipo electrónico Incluido.	Luminaire with electronic equipment Included.	Luminaire avec équipement électronique Inclus.	Luminaire com aparelhagem electrónica Incluido.
	Equipo NO Incluido, pero sí lo necesita	Equipment not Included, but it is required.	Luminaire sans équipement mais il faut l'avoir.	Aparelhagem não Incluída, mas é necessário.
	Prueba superada con éxito de la Temperatura (xxx°) del hilo Incandescente. (°C)	Glow wire temperature test (xxx°) passed successfully (°C)	Essai au fil Incandescent (°C) passé avec succès à la température (°xxx).	Ensaio do fio Incandescente superado com éxito à temperatura (xxx°) especificada. (°C)
	Temperatura ambiental (°C) máxima y mínima para garantizar el funcionamiento de la luminaria.	Maximum and minimum temperature to guarantee proper operation of the lamps.	Températures maximales et minimales pour assurer le fonctionnement des luminaires.	Temperatura máxima e mínima para garantir o funcionamento das luminárias.
	Temperatura máxima de la superficie de la luminaria. (°C)	Maximum temperature (°C) of the glass surface at an average room temperature.	Température maximale (°C) de la surface du verre à la température ambiante.	Temperatura máxima (°C) da superfície do vidro, à temperatura ambiente.
	Ángulo máximo de basculación de la luminaria.	Maximum angle of Inclination of the lamp.	Angle maximal d'Inclinaison du luminaire.	Ángulo máximo de Inclinação da luminária.
	Ángulo máximo de giro horizontal.	Maximum angle of rotation.	Angle maximum de rotation.	Ángulo máximo de rotação.
	 Medidas de empotramiento (mm)	Recess dimensions (mm)	Mesures pour encastrément (mm)	Medidas de encastramento (mm)
	Dimerable.	Dimmable.	Dimmable.	Dimmable.
	NO dimerable.	Non dimmable.	Non dimmable.	Não dimmable.
	Luminaria con lámpara Incluida.	Luminaire with lamp Included.	Luminaire avec lampe Inclus.	Luminária com lâmpada Incluída.
	Anclaje Incluido.	Anchorage Included.	Ancrage Inclus.	Ancoragem Incluido.
	Caja de empotrar Incluída.	Recessing box Included.	Boîtier d'encastrement Inclus.	Caixa embutida Incluido.
	No utilizar en ningún caso tornillos mecánicos.	Never use mechanical screwdrivers.	Surtout ne jamais utiliser de tournevis mécanique.	Não utilizar, em caso algum, aparafusadoras mecânicas.
	Precisa drenaje.	Requires drainage.	Drainage nécessaire.	Drenagem precisa.
	Luminaria adaptada para tránsito no rodado.	Luminaire adapted for non-vehicular traffic.	Luminaire adapté au trafic pas roulé.	Luminária adaptada para trânsito não rodoviário.
	Luminaria adaptada para tránsito rodado.	Luminaire adapted for vehicular traffic.	Luminaire adapté au trafic roulé.	Luminária adaptada para trânsito rodoviário.

	Globo con cierre bayoneta.	Globe with bayonet fitting.	Globe avec fermeture baionnette.	Globo com fecho baioneta.
	Globo con cierre hermético.	Hermetically sealed globe.	Globe avec fermeture hermétique.	Globo com fecho hermético.
	Poste con registro.	Post with inspection chamber.	Poste avec enregistrement.	Lampost com registro.
	Luminarias con alta resistencia a los rayos Ultra Violeta para evitar que el color se deteriore.	Luminaires with high resistance to Ultra-Violet rays to prevent color deterioration.	Luminaires with high resistance to Ultra-Violet rays to prevent color deterioration.	Luminárias com elevada resistência aos raios Ultra Violetas para evitar a deterioração da cor.
	Luminaria con una excelente resistencia a la corrosión (aluminio con doble recubrimiento de pintura, acero con proceso de galvanizado, resina o poliamida)	Luminaire with excellent resistance to corrosion (aluminum with double painting process, steel galvanizing process, resin or polyamide)	Luminaire avec une excellente résistance à la corrosion (aluminium avec double processus de peinture, processus de galvanisation de l'acier, résine ou polyamide)	Luminária com excelente resistência à corrosão (alumínio com processo de pintura dupla, processo de galvanização de aço, resina ou poliamida)
	Luminaria de acero inoxidable que precisa de un mantenimiento periódico.	Stainless steel luminaire which requires periodical maintenance.	Luminaire de acier inoxydable qui a besoin de maintenance périodique.	Luminária do aço inoxidável que precisa de manutenção periódica.
	Luminaria de latón que precisa de mantenimiento periódico con pulimento específico para recuperar el brillo.	Resin luminaries or posts that require a periodic maintenance with specific polishing to restore the brightness.	Luminaire à laiton qui peut nécessiter d'un entretien à polissage spécifique pour récupérer son aspect d'origine.	Luminária de Latão que precisa de manutenção periódica com polimento específico para recuperar o brilho.
	Luminaria o poste de resina que precisa de mantenimiento periódico con aceite sintético para recuperar el brillo.	Resin luminaries or posts that require a periodic maintenance with synthetic oil to restore the brightness.	Luminaire ou mât à résine qui peut nécessiter d'un entretien à l'huile synthétique pour récupérer son aspect d'origine.	Luminária ou poste de resina que precisa de manutenção periódica com óleo sintético para recuperar o brilho.
	Acabado del poste de acero cincado con lo que debe pintarse forzosamente una vez instalado.	Post is finished in zinc-plated steel and therefore must be painted once installed.	Mât en acier Galvanisé ce qui doit nécessairement être peint une fois installé	Acabamento do poste é em aço zincado, razão por que deve ser pintado forçosamente depois de instalado.
	Posibilidad de aplicar acabados especiales.	Possibility of special finishings.	Autres finitions spéciales possibles.	Possibilidade de acabamentos especiais.
	Vida útil (horas).	Life (hours).	Durée (heures).	Longevidade (horas).
	Índice de reproducción cromática.	Color rendering index.	Index de rendu des couleurs.	Índice de reprodução de cor.
	Respuesta de encendido (seg.)	Power response (sec.).	Réponse d'allumage (sec).	Resposta de ignição (sec).
	Batería recargable.	Rechargeable battery.	Batterie rechargeable.	Bateria recarregável.
	Tiempo de carga completa (horas).	Charge Time (hours).	Temps de charge complète (heures).	Tempo de carga completa (horas).
	Autonomía de la batería (horas).	Battery Autonomy (hours).	Autonomie de la batterie (heure).	Autonomia da batería (horas).
	Incluye mando a distancia.	Include remote control.	Télécommande Incluse.	Inclui comando a distancia.
	Número de colores.	Number of colors.	Nombre de couleurs.	número de cores.
	Número de secuencias de cambio de color.	Number of sequences.	Nombre de séquences de changement de couleur.	Número de sequências de mudança de cor.
	Tramo mínimo de corte (cm)	Minimum cutting section (cm)	Section minimale de découpe (cm)	Seção de corte mínima (cm)
	Longitud máxima de unión de tiras led (10m)	Maximum length interconnected (10m)	Longueur maximale totale des rubans à led connectés (10m)	Longitud máxima de unión de tiras led (10m)
	Longitud (5m) de la tira led (mínima unidad de venta)	Standard length (5m) (Minimum Order)	Longueur (5m) du ruban à led (unité de vente minimale)	Longitud (5m) de la tira led (mínima unidad de venta)
	Motor con corriente alterna.	Alternate current motor.	Moteur à courant alternatif.	Motor com corrente alternada.
	Motor con corriente continua.	Direct current motor.	Moteur à courant continu.	Motor com corrente contínua.
	Ventilador con luz.	Fan with lamp.	Ventilateur de plafond lumineux	Ventilador com luz.
	Número de aspas del ventilador.	Number of fan blades.	Nombre d'ailettes du ventilateur.	Numero de pá do ventilador.
	Función inversa para usarlo todo el año.	Inverse function to use it the whole year.	Fonction réversible conçue pour une utilisation toute l'année.	Função inversa para usar todo o ano.
	Regulador de pared.	Wall control.	Variateur mural.	Regulador de parede.



# Condiciones de venta

## Condições de venta

# Condiciones de venta

Todos los pedidos cursados a Grupo Gestión Integral Novolux Internacional, S.L. en adelante "NOVOLUX", implican la aceptación íntegra, por parte del comprador, de las presentes Condiciones Generales de Venta, salvo condiciones particulares pactadas.

## 1. Precios

Para todo tipo de pedido en **Oferta Comercial Estándar y Bajo Pedido (con referencia en catálogo)** se aplicará la tarifa y condiciones comerciales vigentes en la fecha de recepción de dicho pedido.

Para aquellos pedidos de **Ejecuciones Especiales (sin referencia en catálogo)**, se deberá solicitar una oferta por escrito a NOVOLUX.

Sólo se aplicarán los **precios especiales de las ofertas**, sobre los pedidos íntegros de los mismos. Cualquier alteración sobre la oferta íntegra original por parte del cliente, puede suponer una revisión de las condiciones iniciales de la oferta.

## 2. Gestión Pedidos

Un pedido no se considerará recepcionado, hasta que la totalidad del mismo se haya cursado correctamente (referencia, color, accesorios, P.V.P. etc.).

El envío de un pedido a NOVOLUX expresara la voluntad de compra por parte del cliente. En el caso que el pedido no pueda ser servido, por el motivo que sea, NOVOLUX informará al cliente de dicha imposibilidad en la mayor brevedad posible. Los pedidos con precios erróneos o discrepancias con las condiciones registradas y/o acordadas por NOVOLUX, no serán tramitados hasta recibir la confirmación escrita del cliente. El correo (e-mail) al cual NOVOLUX solicitará dicha confirmación y aceptación será el que se indique en el pedido recibido del cliente.

Cualquier Pedido recibido que incluya referencias que supongan Ejecuciones Especiales y/o Bajo Pedido requerirá ser aceptado por parte de NOVOLUX, confirmando en factibilidad de producción, precio y plazo de entrega antes de su tramitación. NOVOLUX solicitará el pago por anticipado de, como mínimo, el 30% del valor del pedido (impuestos incluidos).

Los pedidos recibidos que no indiquen lo contrario serán servidos parcialmente en caso de no disponer en stock de la totalidad de los ítems incluidos en él y los portes tendrán la misma condición que el pedido original, entregando los restos de pedido a portes pagados si el pedido ya cumplía la condición inicialmente.

Aquellos pedidos en los que no se indique la voluntad expresa del cumplimiento de un plazo de entrega, serán gestionados según se expone en el punto anterior. En el caso que el cumplimiento del plazo de entrega del pedido total o parcialmente sea requisito indispensable para el cliente, este deberá solicitar plazo de entrega por escrito a NOVOLUX.

Todo pedido inferior a 100€ netos tendrán un cargo de 15€ por gastos de gestión.

## 3. Devoluciones

Para realizar cualquier devolución, se deberá solicitar autorización previamente a NOVOLUX.

Los productos de **Ejecuciones Especiales, Bajo Pedido o descatalogados no podrán ser devueltos**, ni aun proponiendo una depreciación. Los productos que sean objeto de solicitud de devolución deben haber sido facturados dentro de los 60 días anteriores a la solicitud.

No se aceptarán devoluciones de productos que no estén en perfecto estado para la venta, incluido su embalaje original. Si por esta causa el cliente solicita el retorno de la mercancía devuelta, el envío de retorno será a portes debidos.

El plazo de devolución del material a NOVOLUX, una vez autorizada, será de máximo 10 días.

A todo producto devuelto se le **aplicará la siguiente depreciación sin excepción**:

- Solicitud hasta 30 días posteriores a la fecha de factura..... 10% de depreciación sobre el valor de la devolución, con un mínimo de 20€ por gastos de gestión.
- Solicitud hasta 60 días posteriores a la fecha de factura..... 15% de depreciación sobre el valor de la devolución, con un mínimo de 20€ por gastos de gestión.

## 4. Entregas / Transportes

Salvo que se acuerden otros términos de transporte, las mercancías viajarán por cuenta y riesgo del comprador en condiciones franco fábrica (EXWORKS para envíos internacionales).

Los pedidos que no lleguen a portes francos mínimos (consulte importe de su zona) y no indiquen medio de transporte del cliente, serán enviados con portes cargados en factura.

**No se admitirán reclamaciones por roturas o incidencias en el transporte transcurridas 72 horas desde de la recepción de la mercancía.**

NOVOLUX sólo se responsabilizará de las incidencias en la entrega, cuando envíe mercancías a portes pagados (a cargo de NOVOLUX).

Los riesgos concernientes a la devolución de las mercancías, correrán siempre a cargo del comprador.

## 5. Plazos de disponibilidad (franco fábrica)

Los plazos de disponibilidad de mercancía dados por NOVOLUX son siempre aproximados y pueden estar sujetos a variaciones debidas a los propios procesos de gestión de los pedidos, o a terceros responsables del transporte de mercancías y/o suministro de componentes.

Estas posibles variaciones en los plazos, en ningún caso suponen aceptación de responsabilidad o de penalizaciones por demora por parte de NOVOLUX.

## 6. Servicio especial (CRISTHER 1 hora / DOPO 60 Minutos / EXO 60 Minutos)

Nuestro servicio especial garantiza la preparación del pedido y su puesta a disposición del transitario o transportista designado, en nuestros almacenes en el plazo de 1 hora.

En este servicio los artículos tendrán un cargo de +6%.

Los plazos de transporte no son responsabilidad de NOVOLUX.

## 7. Proyectos de iluminación

Como servicio adicional a nuestros clientes, disponemos de nuestro propio Departamento Técnico de Proyectos, donde pueden consultar cualquier necesidad lumínica de interior y exterior.

El nivel de prestación de nuestras realizaciones, se adecua a las necesidades de cada proyecto.

## 8. Muestras

Las muestras de material deberán ser solicitadas mediante pedido y serán facturadas.

El plazo de devolución de las muestras a NOVOLUX, será de un máximo de 30 días desde la fecha que figure en el albarán de entrega y se devolverán a portes pagados.

Las muestras devueltas que no estén en condiciones para la venta (en perfecto estado y con su embalaje original), no podrán ser abonadas.

## 9. Calidad

Los productos suministrados por NOVOLUX, cumplen con la directiva RoHS 2002/95/CE y con la Norma Europea que marcan las directivas 2006/95/CE indicándose de forma visible tanto en el producto como en su caja exterior. Además, de haber sido sometidos a rigurosos controles de calidad que garantizan su correcto funcionamiento.

NOVOLUX, trabaja permanentemente para mejorar y adecuar sus productos.

Por ello, nos reservamos el derecho a modificar, suprimir o ampliar nuestros productos en catálogo sin previo aviso, y sin que ello sea motivo de reclamaciones.

Dependiendo de los materiales de fabricación y para su máxima optimización en el tiempo, NOVOLUX recomienda realizar los trabajos de mantenimiento con la periodicidad necesaria.

## 10. Garantía

Todos los productos de NOVOLUX, poseen de un periodo de garantía de 2 años desde la fecha de factura de NOVOLUX.

Bajo solicitud, se puede valorar una extensión de garantía u ofrecer una garantía de proyecto personalizada, tras evaluar las condiciones de aplicación.

En el caso de las lámparas, se garantizarán 2 años, siempre que se cumplan las siguientes condiciones de aplicación:

- Temperatura ambiente de max.  $-10^{\circ}\text{C}$  a  $+40^{\circ}\text{C}$ .
- Mín. 10mm de espacio alrededor del cuerpo de la lámpara.
- La instalación eléctrica en la que funcione el producto no debe estar sometida a fluctuaciones de tensión dentro de un intervalo que sobrepase el nominal de la red  $\pm 10\%$ .
- Máx. 50.000 conmutaciones rápidas (tiempo entre encendido y apagado inferior a 30s).

En caso de no cumplirse estas condiciones, se aplicará la garantía legal de 6 meses contra defectos de fabricación.

El Departamento Técnico de NOVOLUX es el único autorizado para determinar si se trata de un defecto de fabricación, después de recibir por escrito la incidencia, donde se exigirá la factura de venta para verificar la fecha.

La responsabilidad de NOVOLUX cubre la sustitución del producto defectuoso, por el mismo modelo u otro similar, o el abono de su valor en caso de que ya no se fabrique o no se encuentre disponible. No le será exigible ninguna otra responsabilidad por garantía o cualquier otro concepto, explícita o implícita, salvo la aquí establecida.

NOVOLUX no asume la responsabilidad por la mala utilización y/o aplicación de sus productos. Nuestros productos perderán su garantía en caso de que sean manipulados indebidamente o instalados incorrectamente.

Quedan excluidos de la garantía los defectos y deterioros causados por el desgaste o uso, por causa de fuerza mayor, mantenimiento defectuoso, o por el uso inadecuado del producto no especificado ni autorizado previamente por el vendedor.

Las intervenciones a título de garantía no tendrán como efecto la prolongación de la duración de la misma.

## 11. Reserva de propiedad

NOVOLUX se reserva el derecho de propiedad de todos los materiales que suministre, hasta que el comprador haya hecho efectivo el pago total de los mismos.

## 12. Jurisdicción

Para cualquier discrepancia o litigio que se derive de las citadas Condiciones Generales de Venta, ambas partes se someten a la competencia de los Juzgados y Tribunales de Barcelona, con expresa renuncia a su fuero propio.

# Condições de venda

Todos os pedidos endereçados e registados pelo Grupo Gestión Integral Novolux Internacional, S.L., daqui para a frente "NOVOLUX" implicam a aceitação na íntegra, por parte do comprador, das presentes Condições Gerais de Venda, salvo condições particulares acordadas.

## 1. Preços

Para todo o tipo de pedido/encomenda em **Oferta Comercial Normal e Sob Pedido (com referencia em catálogo)** se aplicará a tabela de preços vigente na data de recepção da dita encomenda/pedido, com os descontos acordados e em vigor.

Para aqueles pedidos/encomendas de **Execuções Especiais (sem referencia em catálogo)**, se deverá solicitar uma oferta/proposta por escrito a NOVOLUX.

Só se aplicarão os **preços especiais das ofertas**, sobre os pedidos íntegros dos mesmos. Qualquer alteração sobre a oferta/proposta íntegra original por parte do cliente, pode supor uma revisão das condições iniciais da oferta/proposta.

## 2. Gestão de Pedidos/Encomendas

Um pedido não se considera recepcionado, até que a totalidade do mesmo, tenha sido processado corretamente (referencia, cor, acessórios, P.V.P., etc.).

O envio de um pedido/encomenda à NOVOLUX, expressa a vontade de compra por parte do cliente. No caso em que o pedido não possa ser servido, pelo motivo que seja, NOVOLUX informará o cliente da dita impossibilidade com a maior brevidade possível. Os pedidos com preços errados ou discrepâncias com as condições registadas e/ou acordadas pela Novolux, não serão processados até receber a confirmação escrita do cliente. O correio (e-mail) ao qual NOVOLUX solicitará a dita confirmação e acordo será o que se indica no pedido/encomenda recebido do cliente.

Qualquer pedido/encomenda recebido incluindo referencias que suponham Execuções Especiais deverá ser aceite por parte de NOVOLUX, confirmando a possibilidade de ser executado pela produção, preço e prazo de entrega antes do mesmo ser processado, para sua posterior realização. Novolux solicitará o pagamento antecipado de, pelo menos, 30% do valor do pedido (impostos incluídos).

Os pedidos/encomendas recebidos que não indiquem o contrário serão fornecidos parcialmente em caso de não dispor em stock da totalidade dos itens incluídos nele e os valores de portes terão a mesma condição que o pedido/encomenda original, entregando os restos de pedido/encomenda a portes pagos se o pedido/encomenda já cumpria a condição inicialmente.

Aqueles pedidos/encomendas em que não se indique a vontade expressa do cumprimento de um prazo de entrega, serão geridos segundo se expõe no ponto anterior. No caso que o cumprimento do prazo de entrega do pedido/encomenda total ou parcialmente seja requisito indispensável para o cliente, este deverá solicitar prazo de entrega por escrito a NOVOLUX.

Todo o pedido inferior a 100€ Líquidos terá um custo de 15,00€ para custos de gestão.

## 3. Devoluções

Para realizar qualquer devolução, dever-se-á solicitar autorização prévia à NOVOLUX.

Os produtos de **Execuções Especiais ou Sob Pedido ou descatalogados não podem ser devolvidos**, nem mesmo estando sujeitos a uma depreciação.

Os produtos que sejam objeto de solicitação de devolução devem ter sido facturados dentro dos 60 dias anteriores à sua solicitação.

Não se aceitarão devoluções de produtos que não estejam em perfeito estado para a sua venda, incluindo a sua embalagem original. Se por este motivo o cliente solicita o retorno da mercadoria devolvida, o envio de retorno será a portes devidos, ou seja a cargo do cliente.

O prazo de devolução do material à NOVOLUX, uma vez autorizada, será de máximo 10 dias.

A Todo **produto devolvido será aplicada a seguinte depreciação** sem exceção:

- Até 30 dias posteriores à solicitação..... 10% de depreciação sobre o valor da devolução ou 20€ de custos de gestão.
- Até 60 dias posteriores à solicitação.....15% de depreciação sobre o valor da devolução ou 20€ de custos de gestão.

## 4. Entregas / Transportes

Salvo acordo de outros términos de transporte, as mercadorias viajarão por conta e risco do comprador em condições franco/segundo fábrica (EXWORKS para envios internacionais).

Os pedidos que não cheguem ao valor de portes mínimo acordado e não indiquem o meio de transporte do cliente, serão enviados com o valor dos portes na factura. Não se admitirão reclamações por rupturas ou incidências no transporte transcorridas/passadas 72 horas desde a recepção da mercadoria. NOVOLUX só se responsabilizará pelas incidências na entrega, quando se envie mercadorias a portes pagos (a cargo de NOVOLUX).

Os riscos respeitantes à devolução das mercadorias, serão sempre a cargo do comprador.

## 5. Prazos de disponibilidade (franco/segundo fábrica)

Os prazos de disponibilidade da mercadoria dados pela NOVOLUX são sempre aproximados e podem estar sujeitos a variações devidas aos próprios processos de gestão dos pedidos/encomendas, ou a terceiros responsáveis do transporte de mercadorias e/ou fornecimento de componentes.

Estas possíveis variações nos prazos, em nenhum caso supõem a aceitação de responsabilidade ou de penalizações por demora por parte da NOVOLUX.



## 6. Serviço Especial para Espanha e Portugal (CRISTHER 1 hora / DOPO 60 Minutos / EXO 60 Minutos)

O nosso serviço especial garante a preparação do pedido e a sua colocação à disponibilidade do transitário designado nos nossos armazéns no prazo de 1 hora.

Neste serviço os artigos terão um encargo de +6%.

Os prazos de entrega da agência de transporte não são da responsabilidade da NOVOLUX.

## 7. Projetos de iluminação

Como serviço adicional aos nossos clientes, dispomos do nosso próprio Departamento Técnico de Projetos, onde podem consultar qualquer necessidade lumínica de interior e exterior.

O nível de prestação das nossas realizações, adequa-se às necessidades de cada projeto.

## 8. Amostras

As amostras de material deverão ser solicitadas mediante um pedido/encomenda e serão facturadas.

O prazo de devolução das amostras à NOVOLUX, será no máximo de 30 dias a partir da data que figura na Guia de Remessa /Nota de entrega, e serão devolvidas com os portes pagos pelo cliente.

As amostras devolvidas que não estejam em condições para a venda (em perfeito estado e com a sua embalagem original), não poderão ser creditadas.

## 9. Qualidade

Os produtos fornecidos por NOVOLUX, cumprem com a diretiva RoHS 2002/95/CE e a Norma Europeia que marcam as diretivas 2006/95/CE indicando-se de forma visível tanto no produto como na sua caixa exterior. Apesar, de terem sido submetidos a rigorosos controlos de qualidade que garantem o seu correto funcionamento.

NOVOLUX, trabalha permanentemente para melhorar e adequar os seus produtos.

Por isso, reservamo-nos no direito a modificar, suprimir ou ampliar os nossos produtos sem aviso prévio, e sem que este seja motivo de reclamações.

Dependendo dos materiais de fabricação e para sua máxima optimização no tempo, NOVOLUX recomenda realizar os trabalhos de manutenção com a periodicidade necessária.

## 10. Garantia

Todos os produtos de NOVOLUX, possuem de um período de garantia de 2 anos a partir do momento da sua compra, ou seja data da factura. Sob pedido, poder-se-á avaliar uma ampliação da garantia a oferecer, ou uma garantia para um projeto específico, após a avaliação e análise da instalação e do ambiente e das condições de aplicação.

No caso das lâmpadas, existe um período de garantia de 2 anos, sempre que se cumpram as seguintes condições de aplicação:

– Temperatura ambiente de max.  $-10^{\circ}\text{C}$  a  $+ 40^{\circ}\text{C}$ .

– Min. 10mm de espaço em redor do corpo da lâmpada.

– A instalação eléctrica em que funciona o produto não deve estar submetida a flutuações/variações de tensão dentro de um intervalo que ultrapasse o valor nominal da rede  $+/- 10\%$ .

– Máx. 50.000 comutações rápidas (tempo entre o ligado e apagado inferior a 30s)-

Em caso de não se cumprirem estas condições, aplicar-se-á a garantia legal de 6 meses contra defeitos de fabrico.

O Departamento Técnico da Novolux é o único autorizado para determinar se se trata de um defeito de fabrico, depois de receber por escrito a incidência, onde se exigirá a factura de venda bem como a sua data.

A responsabilidade de NOVOLUX cobre a substituição do produto defeituoso, pelo mesmo ou outro similar, ou o crédito do seu valor no caso em que já não se fabrique ou que não se encontre disponível. Não lhe será exigido nenhuma outra responsabilidade por garantia ou qualquer outro conceito, explícita ou implícita, salvo aquela aqui estabelecida.

NOVOLUX não assume a responsabilidade pela má utilização e/ou aplicação dos seus produtos. Os nossos produtos perderão a sua garantia em caso de que sejam manipulados indevidamente ou instalados incorretamente.

Ficam excluídos da garantia os defeitos e deteriorações causados pelo desgaste ou uso, por causa de força maior, manutenção defeituosa, ou pelo uso inadequado do produto não especificado nem autorizado previamente pelo vendedor.

As intervenções a título de garantia não terão como efeito o prolongamento da duração da mesma.

## 11. Reserva de Propriedade

NOVOLUX reserva-se no direito de propriedade de todos os materiais que fornece, até que o comprador tenha feito o pagamento total dos mesmos.

## 12. Jurisdição

Para qualquer discrepância ou litígio que derive das citadas Condições Gerais de Venda, ambas partes se submetem à competência dos Juizes e Tribunais de Barcelona, com expressa renúncia ao seu foro próprio.



# Índice de referencias

Reference index

Index référence

Referência índice

REF.	PAG	ENERGY CLASS
368C-L2305D-01	273	A++,A+,A
369C-L2308D-01	273	A++,A+,A
369C-L2308D-02	273	A++,A+,A
369D-L2003B-01	273	A++,A+,A
369D-L2003B-02	273	A++,A+,A
371A-L3309B-01	273	A++,A+,A
378A-L3103A-01	271	A++,A+,A
378A-L3103A-02	271	A++,A+,A
378A-L3104A-01	271	A++,A+,A
378A-L3106A-01	271	A++,A+,A
378A-L3106A-02	271	A++,A+,A
378B-L3107A-01	271	A++,A+,A
378B-L3107A-02	271	A++,A+,A
378B-L3110A-01	271	A++,A+,A
378B-L3110A-02	271	A++,A+,A
378C-L3111A-01	271	A++,A+,A
378C-L3111A-02	271	A++,A+,A
412A-LO103B-40	78	A++,A+,A
412B-LO1E2B-40	78	A++,A+,A
412B-LO1F1B-01	78	A++,A+,A
412B-LO1F1B-40	78	A++,A+,A
419B-LO1D1B-40	80	A++,A+,A
426B-G21X1A-01	98	A++,A+,A,B,C,D,E
426B-G21X1A-02	98	A++,A+,A,B,C,D,E
464A-LO124F-00	262	A++,A+,A
464A-LO172F-00	262	A++,A+,A
464A-LO224F-00	262	A++,A+,A
464A-LO472F-00	263	A++,A+,A
464B-LO105F-00	262	A++,A+,A
464B-LO115F-00	262	A++,A+,A
464B-LO205F-00	262	A++,A+,A
464B-LO415F-00	263	A++,A+,A
464C-LO172F-00	262	A++,A+,A
464D-LO115F-00	262	A++,A+,A
465A-LO124F-29	265	A++,A+,A
465B-LO172F-29	264	A++,A+,A
465C-LO115F-29	264	A++,A+,A
465D-LO172F-29	264	A++,A+,A
465E-LO115F-29	264	A++,A+,A
465F-LO124F-29	264	A++,A+,A
465F-LO224F-29	264	A++,A+,A
465F-LO472F-29	265	A++,A+,A
465G-LO105F-29	264	A++,A+,A
465G-LO205F-29	264	A++,A+,A
465G-LO415F-29	265	A++,A+,A
493A-G04X1A-32	240	A++,A+,A,B,C,D,E
494A-G31X1A-32	245	A++,A+,A,B,C,D,E

REF.	PAG	ENERGY CLASS
495A-G04X1A-28	241	A++,A+,A,B,C,D,E
497A-LO105A-01	87	A++,A+,A
497A-LO105A-39	87	A++,A+,A
498A-LO105A-01	86	A++,A+,A
499A-G05X1A-39	154	A++,A+,A,B,C,D,E
500A-G05X1A-32	103	-
501A-G05X1A-28	102	A++,A+,A,B,C,D,E
501B-G05X1A-28	102	A++,A+,A,B,C,D,E
503A-F0340B-01	101	A+,A,B
503A-F0340B-32	101	A+,A,B
503B-F03G3B-32	101	A+,A,B
503B-LO150B-01	101	A++,A+,A
503B-LO150B-32	101	A++,A+,A
504A-LO108A-01	82	A++,A+,A
504A-LO108A-40	82	A++,A+,A
504B-LO124A-01	82	A++,A+,A
504B-LO124A-40	82	A++,A+,A
504C-LO105A-01	82	A++,A+,A
504C-LO105A-40	82	A++,A+,A
505A-F13B7B-35	100	A++,A+,A,B,C,D,E
505A-LO124A-35	100	A++,A+,A,B,C,D,E
505B-F02C5B-35	100	A++,A+,A,B,C,D,E
505B-LO148B-35	100	A++,A+,A,B,C,D,E
505C-F02F8B-35	100	A++,A+,A,B,C,D,E
507A-Y05X1B-35	38	A++,A+,A,B,C,D,E
507A-Y05X1B-46	38	A++,A+,A,B,C,D,E
507B-G05X1A-35	40	A++,A+,A,B,C,D,E
507C-G05X1A-35	188	A++,A+,A,B,C,D,E
507D-G05X1A-35	188	A++,A+,A,B,C,D,E
507E-Y05X1B-35	38	A++,A+,A,B,C,D,E
507F-Y05X1B-35	38	A++,A+,A,B,C,D,E
507F-Y05X1B-46	38	A++,A+,A,B,C,D,E
508A-F02B7B-32	242	A+,A
510A-Y04X1B-35	56	A++,A+,A
511A-LO103H-29	237	A++,A+,A
513A-LO109B-32	243	A++,A+,A
513B-LO112B-32	243	A++,A+,A
514A-LO109B-32	244	A++,A+,A
514B-LO112B-32	244	A++,A+,A
515A-LO1D2B-32	250	A++,A+,A
516A-Y04X1B-32	57	A++,A+,A,B,C,D,E
517B-LO103B-35	66	A++,A+,A
517B-LO103B-46	66	A++,A+,A
517D-LO103B-35	66	A++,A+,A
517E-LO103B-35	66	A++,A+,A
517E-LO103B-46	66	A++,A+,A
518A-LO103A-35	67	A++,A+,A

REF.	PAG	ENERGY CLASS
518B-LO103A-35	67	A++,A+,A
578A-L2104A-01	273	A++,A+,A
578A-L2104A-02	273	A++,A+,A
578A-L2105A-01	273	A++,A+,A
578A-L2105A-02	273	A++,A+,A
583A-LO140B-01	275	A++,A+,A
583A-LO240B-01	275	A++,A+,A
584A-LO105A-01	88	A++,A+,A
584B-LO1H4A-01	148	A++,A+,A
585A-G05X1A-02	162	A++,A+,A,B,C,D,E
586A-G05X1A-01	168	A++,A+,A,B,C,D,E
588A-LO104A-02	68	A++,A+,A
588B-LO104A-02	232	A++,A+,A
589A-G05X1A-35	92	-
590A-F0322B-32	99	-
591A-LO1H5A-32	238	A++,A+,A
591B-LO104A-32	238	A++,A+,A
592A-LO105A-03	74	A++,A+,A
593A-LO108A-01	172	A++,A+,A
593A-LO108A-03	172	A++,A+,A
594A-G05X1A-01	144	A++,A+,A,B,C,D,E
595A-G05X1A-35	36	A++,A+,A,B,C,D,E
596A-Y05X1A-32	58	A++,A+,A
596B-Y05X1A-32	190	A++,A+,A
596C-Y05X1A-32	190	A++,A+,A
597A-G05X1A-01	145	A++,A+,A,B,C,D,E
598A-LO124B-35	229	A++,A+,A
599A-LO118B-01	275	A++,A+,A
599A-LO124B-01	275	A++,A+,A
599A-LO218B-01	275	A++,A+,A
599A-LO224B-01	275	A++,A+,A
599A-LO318B-01	275	A++,A+,A
600A-Y05X1A-35	48	A++,A+,A
600B-G05X1A-35	48	A++,A+,A,B,C,D,E
600C-G05X1A-35	48	A++,A+,A,B,C,D,E
600D-G05X1A-35	197	A++,A+,A,B,C,D,E
600E-G05X1A-35	196	A++,A+,A,B,C,D,E
600F-G05X1A-35	196	A++,A+,A,B,C,D,E
600G-G05X1A-35	49	A++,A+,A
601A-G05X1A-32	170	-
601A-G05X1A-37	170	-
602A-G05X1A-32	198	A++,A+,A,B,C,D,E
602B-G05X1A-32	199	A++,A+,A,B,C,D,E
603A-LO105A-32	68	A++,A+,A
605A-G04X1A-10	155	A++,A+,A,B,C,D,E
606A-LO105A-01	247	A++,A+,A
606B-LO1G2A-01	247	A++,A+,A

REF.	PAG	ENERGY CLASS
607A-G05X1A-35	216	A++,A+,A,B,C,D,E
608A-G05X1A-40	171	A++,A+,A,B,C,D,E
610A-G05X1A-01	168	A++,A+,A,B,C,D,E
610A-G05X1A-02	168	A++,A+,A,B,C,D,E
610A-G05X1A-42	168	A++,A+,A,B,C,D,E
611A-Y05X1A-35	46	A++,A+,A,B,C,D,E
611B-G05X1A-35	44	A++,A+,A,B,C,D,E
611C-G05X1A-35	42	A++,A+,A,B,C,D,E
611D-G05X1A-35	194	A++,A+,A,B,C,D,E
611E-G05X1A-35	192	A++,A+,A,B,C,D,E
611F-G05X1A-35	192	A++,A+,A,B,C,D,E
612A-G05X1A-32	90	A++,A+,A,B,C,D,E
613A-LO105A-01	87	A++,A+,A
614A-G05X1A-02	226	A++,A+,A,B,C,D,E
614B-G05X1A-02	226	A++,A+,A,B,C,D,E
615A-G05X1A-32	212	A++,A+,A,B,C,D,E
616A-LO103A-40	60	A++,A+,A
617A-LO105A-39	232	A++,A+,A
618A-G05X1A-02	166	A++,A+,A,B,C,D,E
620A-G05X1A-02	162	A++,A+,A,B,C,D,E
621A-G05X1A-50	204	A++,A+,A,B,C,D,E
621B-G05X1A-50	204	A++,A+,A,B,C,D,E
621C-G05X1A-50-CA	28	A++,A+,A,B,C,D,E
621C-G05X1A-50-CG	28	A++,A+,A,B,C,D,E
621C-G05X1A-50-DC	28	A++,A+,A,B,C,D,E
622A-G05X1A-02	214	A++,A+,A,B,C,D,E
623A-LO103A-32	238	A++,A+,A
624A-LO103A-35	70	A++,A+,A
625A-LO106A-35	70	A++,A+,A
625B-LO112A-35	70	A++,A+,A
626A-G05X1A-32	91	A++,A+,A,B,C,D,E
632C-LO504B-01	272	A++,A+,A
632C-LO506B-01	272	A++,A+,A
632C-LO506B-02	272	A++,A+,A
632D-LO404B-01	272	A++,A+,A
632E-LO404B-01	272	A++,A+,A
632F-LO504B-01	272	A++,A+,A
632G-LO504B-01	272	A++,A+,A
632H-LO504B-01	272	A++,A+,A
633A-LO1H8A-35	230	A++,A+,A
634A-H35X1A-01	81	A++,A+,A
634A-H35X1A-03	81	A++,A+,A
634A-LO113B-01	81	A++,A+,A
634A-LO113B-03	81	A++,A+,A
634B-LO113B-01	81	A++,A+,A
634B-LO113B-03	81	A++,A+,A
635A-WL58B-01	258	A++,A+,A

REF.	PAG	ENERGY CLASS
635A-WL58B-03	258	A++,A+,A
636A-WL75B-5 I	256	A++,A+,A
637A-WL90B-07	255	-
638A-VX60B-0 I	254	-
638B-VX82B-0 I	254	-
677A-LO205B-32	248	A++,A+,A
678A-LO206B-32	248	A++,A+,A
679A-LO129B-35	228	A++,A+,A
680A-G04X1A-13	72	-
680B-G04X1A-13	156	-
680C-G05X1A-13	156	-
680D-G04X1A-13	218	-
680E-G04X1A-13	218	-
681A-G05X1A-02	34	A++,A+,A,B,C,D,E
681B-G05X1A-02	208	A++,A+,A,B,C,D,E
681C-G05X1A-02	208	A++,A+,A,B,C,D,E
682A-G05X1A-91	164	A++,A+,A,B,C,D,E
683A-G04X1A-03	140	A++,A+,A,B,C,D,E
683B-G04X1A-03	140	A++,A+,A,B,C,D,E
684A-G05X1A-02	134	A++,A+,A,B,C,D,E
685A-G05X1A-02	132	A++,A+,A,B,C,D,E
685B-G05X1A-02	132	A++,A+,A,B,C,D,E
686A-G05X1A-44	136	A++,A+,A,B,C,D,E
687A-G05X1A-01	138	A++,A+,A,B,C,D,E
687A-G05X1A-37	138	A++,A+,A,B,C,D,E
688A-G05X1A-51	210	A++,A+,A,B,C,D,E
689A-LO124A-40	94	A++,A+,A
690A-LO112A-35	94	A++,A+,A,B,C,D,E
691A-LO116A-40	84	-
692A-LO106A-01	95	A++,A+,A
692A-LO106A-32	95	A++,A+,A
693A-LO112A-35	91	A++,A+,A
694A-LO112A-35	93	A++,A+,A
695A-LO112A-01	84	A++,A+,A
695A-LO112A-32	84	A++,A+,A
696A-LO107A-32	246	A++,A+,A
697A-LO106B-01	89	A++,A+,A
698A-LO105B-37	147	A++,A+,A
699A-LO105B-37	146	A++,A+,A
700A-LO106B-32	61	A++,A+,A
701A-G05X1A-91	222	A++,A+,A,B,C,D,E
701B-G05X1A-91	222	A++,A+,A,B,C,D,E
702A-G05X1A-91	220	A++,A+,A,B,C,D,E
702B-G05X1A-91	220	A++,A+,A,B,C,D,E
703A-G05X1A-51	206	A++,A+,A,B,C,D,E
704A-LO103B-01	59	A++,A+,A
705A-LO103B-01	60	A++,A+,A

REF.	PAG	ENERGY CLASS
705A-LO103B-02	60	A++,A+,A
707A-LO105A-32	246	A++,A+,A
708A-Y05X1A-32	53	A++,A+,A,B,C,D,E
709A-Y05X1A-35	55	A++,A+,A,B,C,D,E
710A-LO103A-02	65	A++,A+,A
710A-LO103A-07	65	A++,A+,A
710B-LO103A-02	65	A++,A+,A
710B-LO103A-07	65	A++,A+,A
711A-LO106A-01	76	A++,A+,A
712A-G04X1A-46	241	A++,A+,A,B,C,D,E
713A-LO106A-01	76	A++,A+,A
714A-G21X1A-32	74	A++,A+,A,B,C,D,E
714B-G21X1A-32	74	A++,A+,A,B,C,D,E
715A-LO125A-01	96, 149	A++,A+,A
715A-LO125A-02	96, 149	A++,A+,A
715A-LO125A-03	96, 149	A++,A+,A
715B-L3135A-01	96, 149	A+
715B-L3135A-02	96, 149	A+
715B-L3135A-03	96, 149	A+
716A-G05X1A-03	122	A++,A+,A,B,C,D,E
716A-G05X1A-07	122	A++,A+,A,B,C,D,E
716A-G05X1A-09	118, 120	A++,A+,A,B,C,D,E
716A-G05X1A-29	118, 120	A++,A+,A,B,C,D,E
716B-G05X1A-03	124	A++,A+,A,B,C,D,E
716B-G05X1A-07	124	A++,A+,A,B,C,D,E
716B-G05X1A-09	124	A++,A+,A,B,C,D,E
716B-G05X1A-29	124	A++,A+,A,B,C,D,E
717C-G05X1A-02	52	A++,A+,A,B,C,D,E
717C-G05X1A-32	52	A++,A+,A,B,C,D,E
717D-G05X1A-01	150	A++,A+,A,B,C,D,E
717D-G05X1A-02	150	A++,A+,A,B,C,D,E
717D-G05X1A-32	150	A++,A+,A,B,C,D,E
717E-G05X1A-01	150	A++,A+,A,B,C,D,E
717E-G05X1A-02	150	A++,A+,A,B,C,D,E
717E-G05X1A-32	150	A++,A+,A,B,C,D,E
717F-G05X1A-01	150	A++,A+,A,B,C,D,E
717F-G05X1A-02	150	A++,A+,A,B,C,D,E
717F-G05X1A-32	150	A++,A+,A,B,C,D,E
717G-G05X1A-02	50	A++,A+,A,B,C,D,E
717G-G05X1A-03	50	A++,A+,A,B,C,D,E
720A-G05X1A-50	128	A++,A+,A,B,C,D,E
720B-G05X1A-50	128	A++,A+,A,B,C,D,E
723A-G04X1A-CM	121	A++,A+,A,B,C,D,E
723B-G04X1A-CM	34	A++,A+,A,B,C,D,E
724A-G05X1A-53	126	A++,A+,A,B,C,D,E
724A-G05X1A-54	126	A++,A+,A,B,C,D,E
725A-G05X1A-29	146	A++,A+,A,B,C,D,E

REF.	PAG	ENERGY CLASS
727A-Y05X1B-01	62	A++,A+,A,B,C,D,E
727B-G05X1A-01	62	A++,A+,A,B,C,D,E
727C-Y05X1B-01	62	A++,A+,A,B,C,D,E
728A-G05X1A-02	152	A++,A+,A,B,C,D,E
728A-G05X1A-35	152	A++,A+,A,B,C,D,E
728A-G05X1A-37	152	A++,A+,A,B,C,D,E
797A-LO121B-92	142	A+
837A-G05X1A-01	182	A++,A+,A,B,C,D,E
837B-G05X1A-01	182	A++,A+,A,B,C,D,E
837C-G05X1A-01	130	A++,A+,A,B,C,D,E
840A-G05X1A-55	112	A++,A+,A,B,C,D,E
840A-G05X1A-56	112	A++,A+,A,B,C,D,E
840B-G05X1A-55	110	A++,A+,A,B,C,D,E
840B-G05X1A-56	110	A++,A+,A,B,C,D,E
841A-Y05X1A-35	54	A++,A+,A,B,C,D,E
842A-LO103B-01	59	A++,A+,A
842A-LO103B-35	59	A++,A+,A
843A-G05X1A-01	160	A++,A+,A,B,C,D,E
844A-G05X1A-01	158	A++,A+,A,B,C,D,E
844A-G05X1A-03	158	A++,A+,A,B,C,D,E
845A-G05X1A-50	202	A++,A+,A,B,C,D,E
845B-G05X1A-50	202	A++,A+,A,B,C,D,E
846A-G05X1A-01	160	A++,A+,A,B,C,D,E
846B-G05X1A-01	72	A++,A+,A,B,C,D,E
846C-G05X1A-01	224	A++,A+,A,B,C,D,E
852A-LO100L-50	200	A+
855A-G05X1A-01	176	A++,A+,A,B,C,D,E
855A-G05X1A-02	176	A++,A+,A,B,C,D,E
855A-G05X1A-37	176	A++,A+,A,B,C,D,E
855B-G05X1A-01	178	A++,A+,A,B,C,D,E
855B-G05X1A-02	178	A++,A+,A,B,C,D,E
855B-G05X1A-37	178	A++,A+,A,B,C,D,E
855C-G05X1A-01	178	A++,A+,A,B,C,D,E
855C-G05X1A-02	178	A++,A+,A,B,C,D,E
855C-G05X1A-37	178	A++,A+,A,B,C,D,E
855D-G05X1A-01	106	A++,A+,A,B,C,D,E
855D-G05X1A-02	106	A++,A+,A,B,C,D,E
855D-G05X1A-37	106	A++,A+,A,B,C,D,E
855E-G05X1A-01	26	A++,A+,A,B,C,D,E
855E-G05X1A-02	26	A++,A+,A,B,C,D,E
855E-G05X1A-37	26	A++,A+,A,B,C,D,E
856A-G05X1A-43	180	A++,A+,A,B,C,D,E
856B-G05X1A-43	180	A++,A+,A,B,C,D,E
856C-G05X1A-43	35	A++,A+,A,B,C,D,E
859A-G05X1A-35-RA	116	A++,A+,A,B,C,D,E
859A-G05X1A-35-RB	116	A++,A+,A,B,C,D,E
859A-G05X1A-35-RC	116	A++,A+,A,B,C,D,E

REF.	PAG	ENERGY CLASS
906A-G21X1A-01	77	A++,A+,A,B,C,D,E
906A-G21X1A-02	77	A++,A+,A,B,C,D,E
906A-G21X1A-37	77	A++,A+,A,B,C,D,E
906B-G21X1A-01	108	A++,A+,A,B,C,D,E
906B-G21X1A-02	108	A++,A+,A,B,C,D,E
906B-G21X1A-37	108	A++,A+,A,B,C,D,E
906C-G21X1A-01	108	A++,A+,A,B,C,D,E
906C-G21X1A-02	108	A++,A+,A,B,C,D,E
906C-G21X1A-37	108	A++,A+,A,B,C,D,E
907A-G05X1A-02-CB	225	A++,A+,A,B,C,D,E
907B-G05X1A-02-CB	64	A++,A+,A,B,C,D,E
908A-LO112B-RA	32	A
908A-LO112B-RB	32	A
908A-LO112B-RC	32	A
908B-LO125B-RA	32	A+
908B-LO125B-RB	32	A+
908B-LO125B-RC	32	A+
908C-LO129B-RA	32	A+
908C-LO129B-RB	32	A+
908C-LO129B-RC	32	A+
908D-LO112B-RA	114	A
908D-LO112B-RB	114	A
908D-LO112B-RC	114	A
908E-LO125B-RA	114	A+
908E-LO125B-RB	114	A+
908E-LO125B-RC	114	A+
908F-LO129B-RA	114	A+
908F-LO129B-RB	114	A+
908F-LO129B-RC	114	A+
908G-G05X1A-35-RA	31	A++,A+,A,B,C,D,E
908G-G05X1A-35-RB	31	A++,A+,A,B,C,D,E
908G-G05X1A-35-RC	31	A++,A+,A,B,C,D,E
909A-G05X1A-01	186	A++,A+,A,B,C,D,E
909A-G05X1A-02	186	A++,A+,A,B,C,D,E
909B-G05X1A-01	186	A++,A+,A,B,C,D,E
909B-G05X1A-02	186	A++,A+,A,B,C,D,E
909C-G05X1A-35-CA	30	A++,A+,A,B,C,D,E
909C-G05X1A-35-CB	30	A++,A+,A,B,C,D,E
909C-G05X1A-35-CG	30	A++,A+,A,B,C,D,E
917A-G05X1A-02-CA	184	A++,A+,A,B,C,D,E
917B-G05X1A-02-CA	184	A++,A+,A,B,C,D,E
A17A-322-03	277	-
A17B-322-01	277	-
A17C-322-01	277	-
A17C-322-02	277	-
A17D-322-01	277	-
A17D-322-02	277	-

REF.	PAG	ENERGY CLASS
A17E-322-01	277	-
A17E-322-02	277	-
A17E-322-03	277	-
A20A-715-01	149	-
A20A-715-02	149	-
A20A-715-03	149	-
A20B-583-01	275	-
A20B-583-38	275	-
A20B-715-01	96	-
A20C-715-01	96	-
A26A-004-CA	38	-
A26A-004-CB	38	-
A26A-004-CC	38	-
A26A-516-CC	57	-
A26B-004-CA	188, 190	-
A26B-004-CB	188, 190	-
A26B-004-CC	188, 190	-
A26C-004-CA	188	-
A26C-004-CB	188	-
A26C-004-CC	188	-
A26D-004-CA	58	-
A26D-004-CC	58	-
A26E-004-CA	52	-
A26E-004-CC	52	-
A26E-004-CE	52	-
A26E-004-CJ	52	-
A26E-004-CK	52	-
A26E-004-HC	52	-
A26G-004-CA	202	-
A26G-004-CC	202	-
A27A-004-CA	38	-
A27A-004-CB	38	-
A27A-004-CC	38	-
A27B-004-CA	188	-
A27B-004-CB	188	-
A27B-004-CC	188	-
A27C-004-CA	188	-
A27C-004-CB	188	-
A27C-004-CC	188	-
A28A-004-CA	42, 192	-
A28A-004-CB	42, 194	-
A28A-004-CC	42, 192	-
A28A-004-RA	42	-
A28A-004-RC	42	-
A28A-004-SA	42	-
A28A-004-SB	42	-
A28B-004-CA	118, 194	-

REF.	PAG	ENERGY CLASS
A28B-004-CB	118, 194	-
A28B-004-CC	118, 194	-
A28B-004-RA	118, 194	-
A28B-004-RC	118, 194	-
A28B-004-SA	118, 194	-
A28B-004-SB	118, 194	-
A28C-004-CA	192	-
A28C-004-CB	192	-
A28C-004-CC	192	-
A28C-004-RA	192	-
A28C-004-RC	192	-
A28C-004-SA	192	-
A28C-004-SB	192	-
A28E-004-CA	53	-
A28E-004-CC	53	-
A29A-004-CA	56	-
A29A-004-CC	56	-
A29B-004-CA	186, 204	-
A29B-004-CB	186	-
A29B-004-CG	186, 204	-
A29B-004-DC	204	-
A29C-004-CA	204	-
A29C-004-CB	186	-
A29C-004-CG	186, 204	-
A29C-004-DC	204	-
A29D-004-CA	206, 210	-
A29E-004-SA	26	-
A29E-004-SB	26	-
A29E-004-SM	26	-
A30A-004-CA	56	-
A30A-004-CC	56	-
A30B-004-CA	48	-
A30B-004-CC	48	-
A30C-004-CA	54	-
A30C-004-CC	54	-
A31A-004-SA	176	-
A31A-004-SB	176	-
A31A-004-SM	176	-
A31B-004-SA	178	-
A31B-004-SB	178	-
A31B-004-SM	178	-
A31C-004-SA	178	-
A31C-004-SB	178	-
A31C-004-SM	178	-
A32A-004-CA	36, 120	-
A32A-004-CB	36, 120	-
A32A-004-CC	36, 120	-



REF.	PAG	ENERGY CLASS
A32B-004-CA	50, 122	-
A32B-004-CC	50, 122	-
A32B-004-CE	50, 122	-
A32B-004-CJ	50, 122	-
A32B-004-CK	50, 122	-
A32B-004-HC	50, 122	-
A32C-004-CA	50, 122	-
A32C-004-CC	50, 122	-
A32C-004-CE	50, 122	-
A32C-004-CJ	50, 122	-
A32C-004-CK	50, 122	-
A32C-004-HC	50, 122	-
A32D-004-CA	122	-
A32D-004-CC	122	-
A32D-004-CE	122	-
A32D-004-CJ	122	-
A32D-004-CK	122	-
A32D-004-HC	122	-
A33A-004-CA	198	-
A33A-004-CB	198	-
A33B-004-CA	199	-
A33B-004-CB	199	-
A35A-004-CA	208	-
A35C-004-CA	34, 208	-
A36A-004-CA	197	-
A36A-004-CC	197	-
A36B-004-CA	196	-
A36B-004-CC	196	-
A36C-004-CA	196	-
A36C-004-CC	196	-
A36D-004-CA	49	-
A36D-004-CC	49	-
A36E-004-CA	55	-
A36E-004-CC	55	-
A37A-004-SA	106	-
A37A-004-SB	106	-
A37A-004-SM	106	-
A50A-778-39	268	-
A50B-778-39	268	-
A50C-778-00	268	-
A50D-778-00	268	-
A50E-778-39	268	-
A50F-778-39	268	-
A50G-778-03	268	-
A50H-778-03	268	-
A50I-778-00	268	-
A51A-778-39	269	-

REF.	PAG	ENERGY CLASS
A51B-778-39	269	-
A51C-778-00	269	-
A51D-778-00	269	-
A51E-778-39	269	-
A51F-778-39	269	-
A51G-778-03	269	-
A51H-778-03	269	-
A51I-778-00	269	-
A52A-778-39	270	-
A52B-778-39	270	-
A52C-778-00	270	-
A52D-778-00	270	-
A52E-778-39	270	-
A52F-778-39	270	-
A52G-778-03	270	-
A52H-778-03	270	-
A52I-778-00	270	-
B02A-X3317H-01	278	-
B02A-X3317J-01	278	-
B02A-X3320I-01	278	-
B02A-X33X2F-01	279	-
B02B-X3360B-01	278	-
B02B-X33A2B-01	278	-
B02B-X33A4B-01	278	-
B02C-X33A7D-02	278	-
B02F-X33A8D-32	278	-
B02G-X3306J-01	278	-
B02I-X33F9D-02	278	-
B02I-X33G1D-02	278	-
B02J-X3350D-02	278	-
B02M-X33A5D-03	278	-
B02M-X33A9D-03	278	-
B02N-X3320M-01	278	-
B02O-X3340F-39	279	-
B02O-X3380F-39	279	-
B02O-X33A1F-39	279	-
B02O-X33A4F-39	279	-
B02Q-X3312F-01	279	-
B02Q-X3325F-01	279	-
B02R-X33A1F-01	279	-
B02V-X3335F-00	279	-
B02V-X3360F-00	279	-
B02V-X3396F-00	279	-
B02V-X33A4F-00	279	-
B02W-X3360F-00	279	-
B02X-X33J2F-00	266	-
B02Y-X3360F-00	279	-

REF.	PAG	ENERGY CLASS
B02Y-X33A1F-00	279	-
B02Y-X33A4F-00	279	-
B03A-X33X2A-02	274	-
B03B-X33X2A-02	274	-
B03C-X33X2A-02	274	-
B03D-X33X2A-02	274	-
B04A-X33X2B-01	274	-
B04A-X33X2B-02	274	-
B04B-X33X2B-01	274	-
B04B-X33X2B-02	274	-
B05E-G33A7F-39	265	-
B05F-G33A9F-39	263	-
B05G-G33A8F-39	265	-
B05H-G33A7F-39	263	-
B05I-X33J3F-00	266	-
B05J-X33J4F-00	267	-
B05K-X33J4F-00	267	-
B05L-X33X2E-00	266	-
B05M-X33X2F-00	266	-
B05N-X33X2X-00	267	-
B10A-X33X2A-01	276	-
B10A-X33X2A-02	276	-
B10A-X33X2A-03	276	-
B10B-X33X2A-01	276	-
B10B-X33X2A-02	276	-
B10B-X33X2A-03	276	-
B10C-X33X2A-01	276	-
B10C-X33X2A-02	276	-
B10C-X33X2A-03	276	-
B10D-X33X2A-01	276	-
B10D-X33X2A-02	276	-
B10D-X33X2A-03	276	-
B10E-X33X2A-01	277	-
B10E-X33X2A-02	277	-
B10E-X33X2A-03	277	-
B10F-X33X2A-01	277	-
B10F-X33X2A-02	277	-
B10F-X33X2A-03	277	-
B10G-X33X2A-01	277	-
B10G-X33X2A-02	277	-
B10G-X33X2A-03	277	-
B10H-X33X2A-01	277	-
B10H-X33X2A-02	277	-
B10H-X33X2A-03	277	-
B10I-X33X2A-01	277	-
B10I-X33X2A-02	277	-
B10I-X33X2A-03	277	-

REF.	PAG	ENERGY CLASS
B10J-X33X2A-01	277	-
B10J-X33X2A-02	277	-
B10J-X33X2A-03	277	-
B10K-X33X2A-01	277	-
B10K-X33X2A-02	277	-
B10K-X33X2A-03	277	-
B10L-X33X2A-01	277	-
B10L-X33X2A-02	277	-
B10L-X33X2A-03	277	-
B10N-X33X2A-01	277	-
B10N-X33X2A-02	277	-
B10N-X33X2A-03	277	-
B10O-X33X2A-01	277	-
B10O-X33X2A-02	277	-
B10P-X33X2A-01	277	-
B10P-X33X2A-02	277	-
B10P-X33X2A-03	277	-



Edición:  
Publication:  
Édition:  
Edição:

Concepto gráfico, maquetación y preimpresión:  
Graphic concept, layout and prepress:  
Concept graphique, mise en page et pré-impresion:  
Design gráfico, maqueteação e pré-impresão:

02/19

**NOVOLUX**  
by novotonic

# NOVOLUX

LIGHTING

**Cristher**<sup>lighting</sup>  
architectural outdoor

**Dopo**<sup>lighting</sup>  
residential outdoor

**exo**<sup>lighting</sup>  
decorative indoor

**indeluz**<sup>lighting</sup>  
technical indoor



[www.gruponovolux.com](http://www.gruponovolux.com)

Marcas registradas de: / Are registered trade marks of: / Ce sont des marques enregistrées de: / Marcas registradas de:  
GRUPO GESTIÓN INTEGRAL NOVOLUX INTERNACIONAL, S.L.