



Cable Management System

Tarifa de precios

303

Sistemas de Tubos, Racores y Prensaestopas



descarga  
PDF y Excel



NUEVA GAMA  
PRENSAESTOPAS

**IRIS**



## Grandes Retos. Grandes Soluciones

Tenemos la solución para la canalización de cables. Innovamos y crecemos desde hace más de 40 años.

### Fiabilidad

Confía en Pemsa. Reducimos sus costes, cumplimos especificaciones y plazos de entrega. Te ofrecemos la solución más adecuada. Amplio Stock de referencias y productos. Equipo de profesionales para atender cualquier consulta.

### Soluciones para profesionales

Sistemas de producto que hacen mejor tu instalación.  
Todas las Soluciones en Bandejas y Tubos. Diseñadas y ensayadas según los estándares internacionales. Soluciones específicas para Alimentaria, Petroquímica, Infraestructuras... Productos desarrollados a partir de nuestra experiencia y la tuya.

## Major Challenges. Great Solutions

We have the solution for cable trays. Innovations and growth for more than 40 years.

### Reliability

Trust in Pemsa. We reduce costs, meet specifications and deadlines. We offer the best solution. Large stock of references and products. Professional team to respond to your requests and enquiries.

### Solutions for professionals

Product systems for the best installation. Complete systems of trays and conduits. Designed and tested to International standards. Specific solutions for Food Industry, Petrochemical, Infrastructure... Products developed from our experience and yours.

## Grandes Desafios. Grandes Soluções

Temos a solução para a condução de cabos. Innovamos e crescemos há mais de 40 anos.

### Fiabilidade

Confie na Pemsa. Reduzimos os seus custos, cumprimos especificações e prazos de entrega. Oferecemos-lhe a solução mais adequada. Amplo Stock de referências e produtos. Equipa de profissionais para atender as suas encomendas e consultas.

### Soluções para profissionais

Sistemas de produto que melhoram a sua instalação. Todos os Sistemas de Calhas e Tubos. Desenhados e ensaiados segundo os standards internacionais. Soluções de produto para os Sectores: Alimentar, Petroquímico e Infra-estruturas... Produtos desenvolvidos a partir da experiência conjunta com os nossos clientes.

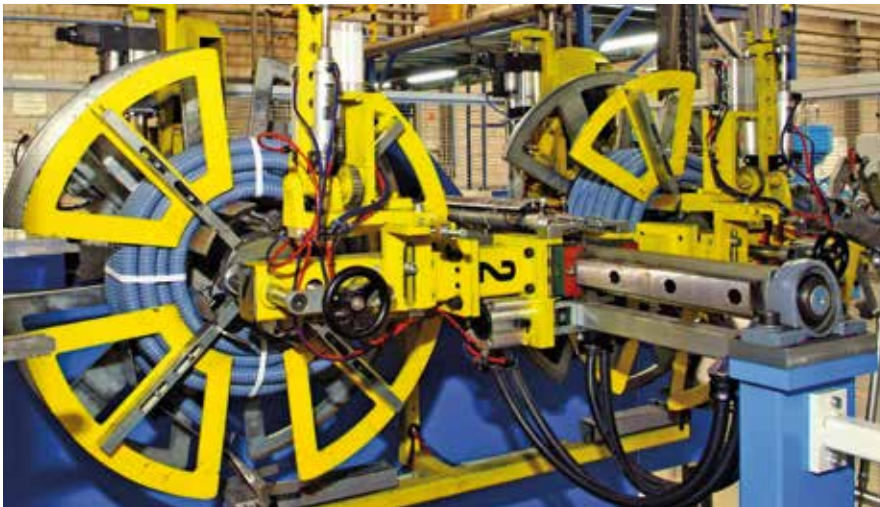

Certificaciones y Homologaciones obtenidas  
Certifications and Approvals obtained  
Certificações e homologações obtidas



Filiales / Branches / Filiais

Pemsa U.K.  
Pemsa France  
Pemsa Portugal

Pemsa Latam.

### Presencia Internacional

Pemsa desarrolla su vocación internacional a través de sus Filiales, **Pemsa UK, Pemsa France, Pemsa Portugal y Pemsa Latinoamérica.** y clientes de los 5 continentes, Oriente Medio, Dubai, Arabia Saudí, Alemania, Bélgica, Italia, Grecia, Marruecos, Senegal, Sudáfrica, Nueva Zelanda, Estados Unidos, Panamá, Costa Rica, Colombia, Ecuador, Perú, Bolivia.

### International Presence

Pemsa develop its international presence through its Branches, **Pemsa UK, Pemsa France, Pemsa Portugal and Pemsa Latin America,** and customers established in the five continents: Middle East, Dubai, Saudi Arabia, Germany, Belgium, Italy, Greece, Morocco, Senegal, South Africa, New Zealand, U.S.A., Panama, Costa Rica, Colombia, Ecuador, Peru, Bolivia...

### Presença Internacional

Pemsa desenvolve a sua vocação internacional através de suas Filiais, **Pemsa UK, Pemsa França, Pemsa Portugal, Pemsa Latinoamérica,** e clientes em 5 continentes, Oriente Médio, Dubai, Arábia Saudita, Bélgica, Itália, Grécia, Marrocos, Senegal, África do Sul, Nova Zelândia, Estados Unidos, Panamá, Costa Rica, Colômbia, Equador, Peru, Bolívia, ...



**Sistema de Tubos Pemsa**  
**Guía de selección**

**Pemsa Conduits System**  
**Selection guide**

**Sistemas de Tubos Pemsa**  
**Guia de Seleção**



	Pemsa Plastic 7035 System					Pemsa Metal Rigid					
Denominación <i>Designation</i> <i>Designação</i>	RLH	RPVC	TM-PVC 7035	CLH	TFA 7035	RL / RLGC	RR / RRG	RAL	RINOX		
Tubo <i>Conduit</i> <i>Tubo</i>											
Características / Features / Características											
	LH	PVC	PG	LH	PVC	EZ	GC	EZ	GC	Aluminio/ Aluminium	304
			PVC		PVC						
<b>DN/SW min.</b>	DN16	DN16	DN7	DN16	DN7	DN16	DN16	DN16	DN16	DN16	DN20
<b>DN/SW max.</b>	DN63	DN63	DN48	DN63	DN48	DN63	DN63	DN63	DN63	DN63	DN40
	-15°C	-15°C	-5°C	-15 °C	-5°C	-45°C	-45°C	-45°C	-45°C	-45°C	-45°C
	+90°C	+90°C	+60°C	+90 °C	+60°C	+400°C	+400°C	+400°C	+400°C	+250°C	+250°C
	Alta / High / Alta		Media Medium Média	Alta High Alta	Media Medium Média	Muy Alta / Very High / Muito alta					
	Rígido / Rigid / Rígido			Media / Medium / Média		Rígido / Rigid / Rígido					
	OK according to IEC 60754-1	OK according to IEC 60754-1		OK according to IEC 60754-1		OK	OK	OK	OK	OK	OK
	OK	OK	OK	OK	OK	OK	OK	OK	OK	OK	OK
	IP54	IP54	IP54	IP67	IP40 / IP65	IP54	IP54	IP54	IP54	IP54	IP54
	4432	4432	4421	2243	2421	5557	5557	4456	5556	5556	5556
Homologaciones / Approvals / Homologações											
Aplicaciones / Applications / Aplicações											
	•	•	•	•	•	•	•	•	•	•	•
	•	•	•	•	•	•	•	•	•	•	•
	•	•	•	•	•	•	•	•	•	•	•
	•	•	•	•	•	•	•	•	•	•	•
	•	•	•	•	•	•	•	•	•	•	•
	•	•	•	•	•	•	•	•	•	•	•
	•	•	•	•	•	•	•	•	•	•	•
	10	11	13	13	13	14-16	14-16	17	17	17	18



Sistema de Tubos Pensa  
Guía de selección

Pemsa Conduits System  
Selection guide

Sistemas de Tubos Pensa  
Guia de Seleção

Pemsa Flexible Metal & Plastic				Pemsaflex /Polyamide System							
TFA	TM	TM-PVC	ECOFLEX	LG-PA	ST-PA	RF-PA	RB-PA	RB-PU	MACRO FLEX	Denominación Designation Designação	Tubo Conduit Tubo
Características / Features / Características											
PVC	PG	PG	PG	Poliamida/ Polyamide 6	Poliamida/ Polyamide 6	Poliamida/ Polyamide 6	Poliamida/ Polyamide 12	Poliuretano/ Polyurethane	Poliamida/ Polyamide 6	(M)	
PVC	PG	PVC	PVC							(M)	
07	07	07	07	07	07	07	07	17	52		<b>DN/SW min.</b>
48	48	48	48	48	48	48	70	70	90		<b>DN/SW max.</b>
-5°C	-45°C	-5°C	-5°C	-40°C	-40°C	-40°C	-50°C	-5°C	-40°C		
+60°C	+150°C	+60°C	+60°C	+105°C	+105°C	+105°C	+105°C	+90°C	+105°C		
Media Medium Média	Muy Alta Very High Muito alta	Media Medium Média	Media Medium Média	Alta High Alta	Muy Alta Very High Muito alta	Muy Alta Very High Muito alta	Muy Alta Very High Muito alta	Muy Alta Very High Muito alta	Muy Alta Very High Muito alta		
Alta High Alta	Alta High Alta	Alta High Alta	Alta High Alta	Alta High Alta	Alta High Alta	Media Medium Média	Muy Alta Very High Muito alta	Muy Alta Very High Muito alta	Media Medium Média		
	OK			OK	OK	OK	OK	OK	OK		
OK	OK	OK	OK	OK	OK	OK	OK	OK	OK		
IP40 / IP65	IP40	IP65	IP65	IP54 / IP67	IP54 / IP67	IP54 / IP67	IP54 / IP67	IP54 / IP67	IP54 / IP67		
2421	4455	4421	3421	2443	2443	3443	2422	1522	2453		
Homologaciones / Approvals / Homologações											
Aplicaciones / Applications / Aplicações											
•	•	•	•	•	•				•		
•	•	•	•	•	•						
		•	•	•	•	•	•	•	•		
•				•	•	•	•	•	•		
		•	•	•	•	•			•		
•	•	•	•	•	•	•	•	•	•		
				•	•	•	•	•	•		
19	19	19	19	23	23	23-24	24	24	24		

**Gama de Prensaestopas. Guía de selección**
*Cable Glands Range. Selection guide*
*Gamme de Presse-Étoupes. Guide de Selection*
*Gama de Bucins. Guia de seleção*

**Nueva Gama IRIS**
**Prensaestopas Plásticos / Plastic Cable Glands / Presse-Étoupes Plastiques / Bucins Plásticos**

Denominación <i>Ranges</i> <i>Désignation</i> <i>Designação</i>	HEXADIN -P	IRIS-P IRIS-P LONG	IRIS -P FLEX IRIS-P FLEX LONG	IRIS -P IP Inserto Plano	IRIS -P IMC Inserto Multi cable	IRIS -P IA Inserto Abierto
Prensaestopa <i>Cable Gland</i> <i>Presse-Étoupe</i> <i>Bucim</i>						

**Características / Features / Caractéristiques / Caraterísticas**

(M)	Poliamida / Polyamide / Polyamide / Poliamida					
(M) Junta / Joint	TPV	TPV	TPV	TPV	TPV	TPV
M	M12-M40	M12-M63	M12-M25	M16-M32	M20-M25	M20-M25
PG	PG7-PG36	PG7-PG48	PG07-PG21	PG09-PG21	PG13-PG21	PG13-PG21
DN Ø	3,5 / 32	3,0 / 44,0	3,0 / 18	2x3 - 16x3 cables	5	5
°C	-20C +100C	-300C +100C	-20 °C +100 °C	-20 °C +100 °C	-20 °C +100 °C	-20 °C +100 °C
UV	Buena/Good/Bon/Bom			Alta/High/Haute/Alta		
🔥	OK	OK	OK	OK	OK	OK
HF	OK	OK	OK	OK	OK	OK
⚡	OK	OK	OK	OK	OK	OK
	RAL 7035	RAL 7035 RAL 7031 RAL 9005	RAL 7035 RAL 7031 RAL 9005	RAL 7035 RAL 7031 RAL 9005	RAL 7035 RAL 7031 RAL 9005	RAL 7035 RAL 7031 RAL 9005
IP	IP54	IP68 - 5 bar	IP68 - 5 bar	IP65	IP65	IP65

**Homologaciones EN 60259 / Approvals EN 60259 / Homologations EN 60259 / Homologações EN 60259**

--	--	--	--	--	--	--

**Aplicaciones / Applications / Applications / Aplicações**

	•	•	•	•	•	•
		•	•	•	•	•
		•	•	•	•	•
		•	•	•	•	•
	39	40-41	41-42	43	44-45	46



Gama de Prensaestopas. Guía de selección  
 Cable Glands Range. Selection guide  
 Gamme de Presse-Étoupes. Guide de Selection  
 Gama de Bucins. Guia de Seleçõ



**Nueva Gama IRIS**

**Prensaestopas Metálicos / Metal Cable Glands / Presse-Étoupes Metalliques / Bucins Metálicos**



Características / Features / Caractéristiques / Caraterísticas

Latón Niquelado / Nickel-Plated Brass / Laiton Nickelé / Latão Niquelado

304

Neopreno	NBR	TPV	SILICONE	TPV	TPV	TPV	TPV
M12-M63	M12-M63	M12-M63	M12-M63	M63-M90	M12-M32	M12-M63	M12-M63
PG7-PG36	PG7-PG36	PG07-PG48	PG07-PG48	-	PG07-PG21	PG09-PG29	PG07-PG48
4,0 / 46,0	3,0 / 48,0	3,5 / 44	3,5 / 44	45 / 70	4 / 18	7x13-14x45 mm 2x3/16x3 cables 5 mm	3,5 / 44
-25°C	-40°C	-20 °C	-60 °C	-20 °C	-20 °C	-40°C	-20 °C
+60°C	+100°C	+100 °C	+180°C	+100°C	+100°C	+100°C	+100°C
Alta/High/Haute/ Alta	Muy Alta/Very High/ Très Haute/Muito Alta				Alta / High / Haute /Alta		
OK	OK	OK	OK	OK	OK	OK	OK
OK	OK	OK	OK	OK	OK	OK	OK
	OK	OK	OK	OK	OK	OK	OK
Metal	Metal	Metal	Metal	Metal	Metal	Metal	Metal
IP54	IP68 - 5 bar	IP68 - 5 bar	IP68 - 5 bar	IP68 - 5 bar	IP68 - 5 bar	IP68	IP68 - 5 bar

Homologaciones EN 60259 / Approvals EN 60259 / Homologations EN 60259 / Homologações EN 60259

--	--	--	--	--	--	--	--

Aplicaciones / Applications / Applications / Aplicações

•	•	•	•			•	•
			•	•	•		
	•	•	•	•	•	•	•
	•	•	•	•	•	•	•
	•	•		•	•	•	•
39	46-47	47	48	48	47-48	49-50	48

**Gama de Prensaestopas. Guía de selección**
*Cable Glands Range. Selection guide*
*Gamme de Presse-Étoupes. Guide de Selection*
*Gama de Bucins. Guia de seleção*

**Nueva Gama IRIS AIR**
**Prensaestopas Plásticos / Plastic Cable Glands / Presse-Étoupes Plastiques / Bucins Plásticos**

Denominación <i>Ranges</i> <i>Désignation</i> <i>Designação</i>	IRIS -P AIR	IRIS -M AIR IRIS-M AIR LONG	IRIS -M AIR INOX IRIS-M AIR INOX LONG	TPK AIR	TPM AIR	TPM AIR INOX
Prensaestopa <i>Cable Gland</i> <i>Presse-Étoupe</i> <i>Bucim</i>						

Características / Features / Caractéristiques / Caraterísticas						
	Poliamida / Polyamide / Poliamida	Latón Niquelado / Nickel-Plated Brass / Laiton Niquelé / Latão Niquelado	AISI 304	Poliamida / Polyamide / Polyamide / Poliamida	Latón Niquelado / Nickel-Plated Brass / Laiton Niquelé / Latão Niquelado	AISI 304
Junta / Joint	TPV	TPV	TPV	NBR	NBR	NBR
M	M12-M16	M12-M20	M12-M16	M12	M12	M12
PG	PG07-PG09	PG07-PG13	PG07-PG13			
<b>DN Ø</b>	4 / 10	4 / 12	4 / 12	Presión a Intrusión de agua / Water Intrusion Pressure 0.8, 0.5, 0.2, 0.1 mbar		
	-20 °C +100 °C	-20 °C +100 °C	-20 °C +100 °C	-20 °C +100 °C	-20 °C +100 °C	-20 °C +100 °C
	Alta/High/Haute/Alta					
Flujo de Aire Air Flow l/h	70	70	70	16, 25, 150, 300	16, 25, 150, 300	16, 25, 150, 300
	OK	OK	OK			
	OK	OK	OK	OK	OK	OK
	RAL 7035 RAL 9005	Metal	Metal	RAL 7035 RAL 9005	Metal	Metal
	IP68	IP68	IP68	IP68	IP68	IP68

**Homologaciones EN 60259 / Approvals EN 60259 / Homologations EN 60259 / Homologações EN 60259**

--	--	--	--	--	--	--

**Aplicaciones / Applications / Applications / Aplicações**

				•	•	
	•	•	•	•	•	•
	•	•	•	•	•	•
	•	•	•	•	•	•
	•	•	•	•	•	•
	•	•	•			•
	50	50	51	60	60	61





Gama de Prensaestopas. Guía de selección  
 Cable Glands Range. Selection guide  
 Gamme de Presse-Étoupes. Guide de Selection  
 Gama de Bucins. Guia de Seleçao

GAMA HSK Prensaestopas industriales

Prensaestopas Metálicos / Metal Cable Glands / Presse-Étoupes Metalliques / Bucins Metálicos

HSK-K	HSK-K-EX	HSK-M	HSK-MZ	HSK-M-EX	HSK-M-EMV-D	HSK-INOX / HD	Denominación Ranges Désignation Designação
							Prensaestopa Cable Gland Presse-Étoupe Bucim
Características / Features / Caractéristiques / Caraterísticas							
Poliamida / Polyamide / Polyamide / Poliamida		Latón Niquelado / Nickel-Plated Brass / Laiton Nickelé / Latão Niquelado				304	(M)
NBR	NBR	NBR	NBR	NBR	NBR	NBR	(M) Junta / Joint
M12-M63	M12-M63	M12-M63	M12-M63	M12-M63	M12-M63	M12-M40	M
PG7-PG48	PG7-PG48	PG7-PG48		PG7-PG48			PG
3,0 / 44,0	3,0 / 44,0	3,0 / 44,0	3,0 / 44,0	3,0 / 44,0	3,0 / 44,0	3,0 / 32,0	DN Ø
-40°C	-40°C	-40°C	-40°C	-40°C	-40°C	-40°C	
+100°C	+100°C	+100°C	+100°C	+100°C	+100°C	+100°C	
Muy Alta / Very High / Très Haute / Muito Alta							UV
VO according to UL94							
OK	OK	OK	OK	OK	OK	OK	HF
OK	OK	OK	OK	OK	OK	OK	
RAL 7035 RAL 9005	RAL 5012 RAL 9005	Metal	Metal	Metal	Metal	Metal	
IP68 - 10 bar							IP
Homologaciones EN 60259 / Approvals EN 60259 / Homologations EN 60259 / Homologações EN 60259							
Aplicaciones / Applications / Applications / Aplicações							
		•					Tertiary
•	•		•	•	•	•	Petrochemical Industry
•			•	•	•		Railwav ann.
•			•	•	•		Energy
		•					Photovoltaic/ Energy
						•	Food Industry
52-53	54-55	53-54	54	55	55	54	

ABRAZADERA	37	FUNDA PROTECTORA PP GRIS	61	PRENSAESTOPAS IRIS -M ROSCA LARGA PG	46
ABRAZADERA I	22	INSERTO ABIERTO IP68	52	PRENSAESTOPAS IRIS PLÁSTICO INSERTO MULTICABLE PG IP65	44
ABRAZADERA PIE RAL	18	INSERTO MULTICABLE IP68	51	PRENSAESTOPAS IRIS PLÁSTICO INSERTO	46
ABRAZADERA PIE RGC	17	INSERTO PLANO IP68	51	PRENSAESTOPAS IRIS PLÁSTICO INSERTO ABIERTO PARA CABLE MÉTRICA IP65	46
ABRAZADERA PIE RINOX	18	JUNTA DE ESTANQUEIDAD TIPO I	38	PRENSAESTOPAS IRIS PLÁSTICO INSERTO ABIERTO PARA CABLE PG IP65	46
ABRAZADERA RGC	17	JUNTA DE ESTANQUEIDAD TIPO II	38	PRENSAESTOPAS IRIS PLÁSTICO INSERTO CABLE PLANO MÉTRICA IP65	43
ABRAZADERA RINOX	18	JUNTA EXTERIOR MÉTRICA	36	PRENSAESTOPAS IRIS PLÁSTICO INSERTO CABLE PLANO PG IP68	43
ABRAZADERA S	37	JUNTA EXTERIOR PG	36	PRENSAESTOPAS IRIS PLÁSTICO INSERTO MULTI-CABLE MÉTRICA IP65	45
ABRAZADERA TIPO II	38	JUNTA INTERIOR	36	PRENSAESTOPA IRIS-M ALTA TEMPERATURA MÉTRICA	48
ADAPTADOR RE-MS MÉTRICA-PG	59	JUNTA PLANA MÉTRICA	58	PRENSAESTOPAS IRIS-M AIR MÉTRICA	50
ADAPTADOR RE-MS PG-MÉTRICA	59	JUNTA PLANA PG	58	PRENSAESTOPAS IRIS-M AIR PG	50
AMPLIACIÓN E-MS MÉTRICA-MÉTRICA	59	JUNTA TORICA MÉTRICA	59	PRENSAESTOPAS IRIS-M AIR ROSCA LARGA	50
AMPLIACIÓN E-MS PG-PG	59	JUNTA TORICA PG	58	PRENSAESTOPAS IRIS-M AIR ROSCA LARGA	50
ANGULAR 90° GIRATORIO GRIS	38	MANGUITO ACOPLAMIENTO	14	PRENSAESTOPAS IRIS-M AIR-INOX MÉTRICA	51
ANGULAR 90° GIRATORIO NEGRO	38	MANGUITO ACOPLAMIENTO CLH (TUERCA INCORPORADA)	12	PRENSAESTOPAS IRIS-M AIR-INOX PG	51
ANGULAR 90° GRIS	38	MANGUITO DE CONEXIÓN RLH	10	PRENSAESTOPAS IRIS-M AIR-INOX ROSCA LARGA MÉTRICA	51
ANGULAR 90° NEGRO	38	MANGUITO DE CONEXIÓN RPVC	11	PRENSAESTOPAS IRIS-M AIR-INOX ROSCA LARGA PG	51
BRIDA FIJACIÓN	13	MANGUITO RAL	17	PRENSAESTOPAS IRIS-M ALTA TEMPERATURA PG	48
CASQUILLO RP PG GRIS	22	MANGUITO RE	14	PRENSAESTOPAS IRIS-M EMC MÉTRICA	47
CINTA HELICOIDAL BLANCA	61	MANGUITO RINOX	18	PRENSAESTOPAS IRIS-M EMC PG	47
CINTA HELICOIDAL NEGRO	61	MANGUITO RL	14	PRENSAESTOPAS IRIS-M FLEX MÉTRICA	47
CLIP FIJACIÓN	13	MANGUITO RLGC	16	PRENSAESTOPAS IRIS-M FLEX PG	47
CLIP PRESION	13	MANGUITO RR	14	PRENSAESTOPAS IRIS-M FLEX ROSCA LARGA MÉTRICA	48
CLIP RAIL	25	MANGUITO RRG	16	PRENSAESTOPAS IRIS-M FLEX ROSCA LARGA PG	47
CLIP RAL	18	PRENSAESTOPA HSK -FLEX MÉTRICA IP68	55	PRENSAESTOPAS IRIS-M INOX MÉTRICA	48
CLIP UNIÓN	25	PRENSAESTOPAS HEXADIN-M MÉTRICA	39	PRENSAESTOPAS IRIS-M INOX PG	48
CODO L	15	PRENSAESTOPAS HEXADIN-M PG	39	PRENSAESTOPAS IRIS-M METÁLICO INSERTO CABLE PLANO MÉTRICA PG IP68	49
CODO R	15	PRENSAESTOPAS HEXADIN-M ROSCA LARGA	39	PRENSAESTOPAS IRIS-M METÁLICO INSERTO CABLE PLANO PG IP68	49
CODO REGISTRABLE DE 90 RPVC	12	PRENSAESTOPAS HEXADIN-P MÉTRICA	39	PRENSAESTOPAS IRIS-M METÁLICO INSERTO MULTICABLE MÉTRICA IP68	49
CURVA 90° RAL	17	PRENSAESTOPAS HEXADIN-P PG	39	PRENSAESTOPAS IRIS-M METÁLICO INSERTO PARA CABLE ABIERTO MÉTRICA IP68	50
CURVA 90° RINOX	18	PRENSAESTOPAS HSK -FLEX MÉTRICA IP68	55	PRENSAESTOPAS IRIS-M METÁLICO INSERTO PARA CABLE ABIERTO PG IP68	50
CURVA 90° RL	15	PRENSAESTOPAS HSK -INOX MÉTRICA IP68	54	PRENSAESTOPAS IRIS-M MÉTRICA IP68	46
CURVA 90° RLH	10	PRENSAESTOPAS HSK -INOX-HD MÉTRICA IP68	54	PRENSAESTOPAS IRIS-M PG IP68	46
CURVA 90° RPVC	11	PRENSAESTOPAS HSK -K -EX MÉTRICA IP68	55	PRENSAESTOPAS IRIS-M XL	48
CURVA 90° RR	15	PRENSAESTOPAS HSK -K -EX PG IP68	54	PRENSAESTOPAS IRIS-P AIR MÉTRICA	50
CURVA DE 90 RPVC	12	PRENSAESTOPAS HSK -K MÉTRICA NEGRO IP68	53	PRENSAESTOPAS IRIS-P AIR PG	50
CURVA FLEXIBLE RLH	11	PRENSAESTOPAS HSK -K ROSCA LARGA MÉTRICA GRIS IP68	53	PRENSAESTOPAS IRIS-P FLEX GRIS MÉTRICA	41
CURVA FLEXIBLE RPVC	12	PRENSAESTOPAS HSK -K ROSCA LARGA PG GRIS IP68	53	PRENSAESTOPAS IRIS-P FLEX GRIS PG	41
CURVA RLGC	16	PRENSAESTOPAS HSK -M -EMV -D MÉTRICA IP68	55	PRENSAESTOPAS IRIS-P FLEX NEGRO MÉTRICA	42
CURVA RRG	17	PRENSAESTOPAS HSK -M -EX MÉTRICA IP68	55	PRENSAESTOPAS IRIS-P FLEX NEGRO PG	41
DERIVACIÓN DT GRIS	35	PRENSAESTOPAS HSK -M -EX PG IP68	55		
DERIVACIÓN DT NEGRO	36	PRENSAESTOPAS HSK -M MÉTRICA IP68	54		
DERIVACIÓN DY GRIS	35	PRENSAESTOPAS HSK -M PG IP68	53		
DERIVACIÓN DY NEGRO	35	PRENSAESTOPAS HSK -MZ MÉTRICA IP68	54		
DERIVACION TL	15	PRENSAESTOPAS HSK-K MÉTRICA GRIS IP68	53		
DERIVACION TR	15	PRENSAESTOPAS HSK-K PG GRIS IP68	52		
FUNDA PROTECTORA PA GRIS	61	PRENSAESTOPAS HSK-K PG NEGRO IP68	52		
FUNDA PROTECTORA PA NEGRO	61	PRENSAESTOPAS IRIS -M ROSCA LARGA MÉTRICA	47		

## Índice de Productos

PRENSAESTOPAS IRIS-P FLEX ROSCA LARGA GRIS MÉTRICA	42	RACOR REP MÉTRICA GRIS IP67	26	TERMINAL PROTECTOR	25
PRENSAESTOPAS IRIS-P FLEX ROSCA LARGA GRIS PG	42	RACOR REP MÉTRICA NEGRO IP67	26	TERMINAL TUBO	15
PRENSAESTOPAS IRIS-P FLEX ROSCA LARGA NEGRO MÉTRICA	42	RACOR REP PG GRIS	26	TOPE PROTECTOR NEGRO	52
PRENSAESTOPAS IRIS-P FLEX ROSCA LARGA NEGRO PG	42	RACOR REP PG NEGRO IP67	27	TOPE PROTECTOR ROJO	52
PRENSAESTOPAS IRIS-P MÉTRICA GRIS IP68	40	RACOR RGM GIRATORIO MÉTRICA	21	TUBO CLH	12
PRENSAESTOPAS IRIS-P MÉTRICA GRIS OSCURO IP68	40	RACOR RGM GIRATORIO PG	20	TUBO ECOFLEX	19
PRENSAESTOPAS IRIS-P MÉTRICA NEGRO IP68	41	RACOR RGP GIRATORIO GRIS CLARO 7035	13	TUBO FLEXIBLE LG-PA GRIS	23
PRENSAESTOPAS IRIS-P PG GRIS IP68	40	RACOR RGP GIRATORIO MÉTRICA	20	TUBO FLEXIBLE LG-PA NEGRO	23
PRENSAESTOPAS IRIS-P PG GRIS OSCURO IP68	40	RACOR RGP GIRATORIO PG	20	TUBO FLEXIBLE RB-PA GRIS	24
PRENSAESTOPAS IRIS-P PG NEGRO IP68	40	RACOR RM MÉTRICA	21	TUBO FLEXIBLE RB-PA GRIS	37
PRENSAESTOPAS IRIS-P ROSCA LARGA MÉTRICA	41	RACOR RM PG	21	TUBO FLEXIBLE RB-PA NEGRO	24
PRENSAESTOPAS IRIS-P ROSCA LARGA PG GRIS	41	RACOR RMH MÉTRICA	22	TUBO FLEXIBLE RB-PA NEGRO	37
PROTECTOR DE TUBO	37	RACOR RMM MÉTRICA	21	TUBO FLEXIBLE RB-PU NEGRO	24
RACOR AB 90 GRIS IP67	31	RACOR RMM PG	21	TUBO FLEXIBLE RB-PU NEGRO	37
RACOR AB 90 NEGRO IP67	31	RACOR RMMH MÉTRICA	22	TUBO FLEXIBLE RF-PA GRIS.	23
RACOR AD IP54 GRIS	30	RACOR RMT	16	TUBO FLEXIBLE RF-PA NEGRO.	24
RACOR AD IP54 NEGRO	30	RACOR RPM MÉTRICA GRIS IP67	35	TUBO FLEXIBLE ST-PA GRIS	23
RACOR AT IP67 GRIS	30	RACOR RPM MÉTRICA NEGR IP67	35	TUBO FLEXIBLE ST-PA NEGRO	23
RACOR AT IP67 NEGRO	30	RACOR RPM PG GRIS IP67	35	TUBO MACROFLEX GRIS	38
RACOR CAJA RLH	10	RACOR RPP MÉTRICA GRIS IP67	34	TUBO MACROFLEX NEGRO	38
RACOR CAJA RLH IP65	10	RACOR RPP MÉTRICA NEGR IP67	34	TUBO PEMSA RLH1250 LIBRE DE HALÓGENOS	10
RACOR CAJA RPVC	11	RACOR RPP PG GRIS IP67	34	TUBO PEMSA RLH750V LIBRE DE HALÓGENOS	10
RACOR P MÉTRICA	20	RACOR RREM MÉTRICA GRIS IP67	29	TUBO PEMSA RPVC RÍDIDO DE PVC	11
RACOR P PG	20	RACOR RREM MÉTRICA NEGRO IP67	29	TUBO PEMSA RPVC750 RÍDIDO DE PVC	11
RACOR PI IP67 GRIS	30	RACOR RREP MÉTRICA GRIS IP67	27	TUBO RAL	17
RACOR PI IP67 NEGRO	30	RACOR RREP MÉTRICA NEGRO IP67	28	TUBO RINOX	18
RACOR RA 45 PG GRIS IP67	31	RACOR RREP PG GRIS IP67	28	TUBO RL	14
RACOR RA 45 PG NEGRO IP67	31	RACOR RREP PG NEGRO IP67	28	TUBO RLGC	16
RACOR RA 90 MÉTRICA GRIS IP67	31	RACOR RRIP MÉTRICA GRIS IP67	28	TUBO RR	14
RACOR RA 90 MÉTRICA NEGRO IP67	31	RACOR RRIP MÉTRICA NEGRO IP67	29	TUBO RRGC	16
RACOR RA 90 PG GRIS IP67	32	RACOR RRIP PG GRIS IP67	29	TUBO TFA GRIS	19
RACOR RA 90 PG NEGRO IP67	32	RACOR RRIP PG NEGRO IP67	29	TUBO TFA GRIS CLARO 7035	13
RACOR RAM 45 MÉTRICA GRIS IP67	33	REDUCCION R-H MÉTRICA-MÉTRICA	59	TUBO TFA NEGRO	19
RACOR RAM 45 MÉTRICA NEGRO IP67	33	SOPORTE MEDIO/FINAL DE TUBO	37	TUBO TM	19
RACOR RAM 90 MÉTRICA GRIS IP67	34	SOPORTE TUBO GRIS	25	TUBO TM-PVC	19
RACOR RAM 90 MÉTRICA NEGRO IP67	34	SOPORTE TUBO NEGRO	25	TUBO TM-PVC GRIS CLARO 7035	12
RACOR RAP 45 MÉTRICA GRIS IP67	32	TAPA SOPORTE GRIS	25	TUERCA TCM ECM MÉTRICA	58
RACOR RAP 45 MÉTRICA NEGRO IP67	32	TAPA SOPORTE NEGRO	25	TUERCA TCM ECM PG	58
RACOR RAP 90 MÉTRICA GRIS IP67	33	TAPON TPK AIR MÉTRICA GRIS	60	TUERCA TCM INOX MÉTRICA	57
RACOR RAP 90 MÉTRICA NEGRO IP67	33	TAPON TPK AIR MÉTRICA NEGRO	60	TUERCA TCM INOX PG	57
RACOR RECTO GRIS	38	TAPON TPK MÉTRICA GRIS IP68	60	TUERCA TCM MÉTRICA	57
RACOR RECTO INTERIOR NEGRO IP65	30	TAPON TPK PG GRIS IP68	60	TUERCA TCM PG	57
RACOR RECTO INTERIOR PG GRIS IP65 30	30	TAPON TPM AIR INOX MÉTRICA	61	TUERCA TCP MÉTRICA GRIS	56
RACOR RECTO NEGRO	38	TAPON TPM AIR MÉTRICA	60	TUERCA TCP MÉTRICA GRIS OSCURO	56
RACOR REM MÉTRICA GRIS IP67	27	TAPON TPM MÉTRICA IP68	60	TUERCA TCP MÉTRICA NEGRO	57
RACOR REM MÉTRICA NEGRO IP67	27	TAPON TPM PG IP68	60	TUERCA TCP PG GRIS	56
		TE REGISTRABLE DE 90 RLH	11	TUERCA TCP PG GRIS OSCURO	56
		TE REGISTRABLE DE 90 RPVC	12	TUERCA TCP PG NEGRO	56

# SISTEMA PLASTIC 7035

## TUBOS RÍGIDOS Y FLEXIBLES PEMSA-LIBRE DE HALÓGENOS

### TUBO PEMSA RLH1250 LIBRE DE HALÓGENOS

Ref.	Descripción	SERIE	GTV	€/m	Unidad Venta	Unidad Embala.	Embalaje	Código EAN
13005116	TUBO RLH1250+MANGUITO DN16 GRIS	0101	1615	<b>2,740</b>	m	57	PAQUETE	8431927067333
13005120	TUBO RLH1250+MANGUITO DN20 GRIS	0101	1615	<b>3,350</b>	m	57	PAQUETE	8431927067340
13005125	TUBO RLH1250+MANGUITO DN25 GRIS	0101	1615	<b>4,620</b>	m	57	PAQUETE	8431927067357
13005132	TUBO RLH1250+MANGUITO DN32 GRIS	0101	1615	<b>6,390</b>	m	30	PAQUETE	8431927067364
13005140	TUBO RLH1250+MANGUITO DN40 GRIS	0101	1615	<b>9,280</b>	m	30	PAQUETE	8431927067371
13005150	TUBO RLH1250+MANGUITO DN50 GRIS	0101	1615	<b>12,460</b>	m	15	PAQUETE	8431927067388
13005163	TUBO RLH1250+MANGUITO DN63 GRIS	0101	1615	<b>16,680</b>	m	15	PAQUETE	8431927067395

### TUBO PEMSA RLH750v LIBRE DE HALÓGENOS

Ref.	Descripción	SERIE	GTV	€/m	Unidad Venta	Unidad Embala.	Embalaje	Código EAN
13006116	TUBO RLH 750+MANGUITO DN16 GRIS	0101	1615	<b>2,280</b>	m	57	PAQUETE	8431927067401
13006120	TUBO RLH 750+MANGUITO DN20 GRIS	0101	1615	<b>2,780</b>	m	57	PAQUETE	8431927067418
13006125	TUBO RLH 750+MANGUITO DN25 GRIS	0101	1615	<b>3,620</b>	m	57	PAQUETE	8431927067425
13006132	TUBO RLH 750+MANGUITO DN32 GRIS	0101	1615	<b>4,760</b>	m	30	PAQUETE	8431927067432
13006140	TUBO RLH 750+MANGUITO DN40 GRIS	0101	1615	<b>6,830</b>	m	30	PAQUETE	8431927067449
13006150	TUBO RLH 750+MANGUITO DN50 GRIS	0101	1615	<b>9,690</b>	m	15	PAQUETE	8431927067456
13006163	TUBO RLH 750+MANGUITO DN63 GRIS	0101	1615	<b>12,880</b>	m	15	PAQUETE	8431927067463

### MANGUITO DE CONEXIÓN RLH

Ref.	Descripción	SERIE	GTV	€/ud	Unidad Venta	Unidad Embala.	Embalaje	Código EAN
55008016	MANGUITO RLH DN16 GRIS	0101	1620	<b>0,900</b>	ud	19	BOLSA	8431927067548
55008020	MANGUITO RLH DN20 GRIS	0101	1620	<b>1,060</b>	ud	19	BOLSA	8431927067555
55008025	MANGUITO RLH DN25 GRIS	0101	1620	<b>1,210</b>	ud	19	BOLSA	8431927067562
55008032	MANGUITO RLH DN32 GRIS	0101	1620	<b>2,210</b>	ud	10	BOLSA	8431927067579
55008040	MANGUITO RLH DN40 GRIS	0101	1620	<b>2,950</b>	ud	10	BOLSA	8431927067586
55008050	MANGUITO RLH DN50 GRIS	0101	1620	<b>4,090</b>	ud	5	BOLSA	8431927067593
55008063	MANGUITO RLH DN63 GRIS	0101	1620	<b>5,290</b>	ud	5	BOLSA	8431927067609

### RACOR CAJA RLH

Ref.	Descripción	SERIE	GTV	€/ud	Unidad Venta	Unidad Embala.	Embalaje	Código EAN
55042016	RACOR CAJA RLH M16 (DN16)	0101	1620	<b>0,389</b>	ud	100	BOLSA	8431927092243
55042020	RACOR CAJA RLH M20 (DN20)	0101	1620	<b>0,499</b>	ud	100	BOLSA	8431927092250
55042025	RACOR CAJA RLH M25 (DN25)	0101	1620	<b>0,662</b>	ud	100	BOLSA	8431927092267
55042032	RACOR CAJA RLH M32 (DN32)	0101	1620	<b>0,845</b>	ud	50	BOLSA	8431927092274
55042040	RACOR CAJA RLH M40 (DN40)	0101	1620	<b>1,045</b>	ud	10	BOLSA	8431927095145
55042050	RACOR CAJA RLH M50 (DN50)	0101	1620	<b>1,412</b>	ud	5	BOLSA	8431927095152
55042063	RACOR CAJA RLH M63 (DN63)	0101	1620	<b>2,888</b>	ud	5	BOLSA	8431927095169

### RACOR CAJA RLH IP65

Ref.	Descripción	SERIE	GTV	€/ud	Unidad Venta	Unidad Embala.	Embalaje	Código EAN
55044016	RACOR CAJA RLH IP65 M16 (DN16)	0101	1620	<b>0,970</b>	ud	19	BOLSA	8431927095244
55044020	RACOR CAJA RLH IP65 M20 (DN20)	0101	1620	<b>1,150</b>	ud	19	BOLSA	8431927095183
55044025	RACOR CAJA RLH IP65 M25 (DN25)	0101	1620	<b>1,420</b>	ud	19	BOLSA	8431927095190
55044032	RACOR CAJA RLH IP65 M32 (DN32)	0101	1620	<b>1,920</b>	ud	10	BOLSA	8431927095206
55044040	RACOR CAJA RLH IP65 M40 (DN40)	0101	1620	<b>2,400</b>	ud	10	BOLSA	8431927095213
55044050	RACOR CAJA RLH IP65 M50 (DN50)	0101	1620	<b>2,950</b>	ud	5	BOLSA	8431927095220
55044063	RACOR CAJA RLH IP65 M63 (DN63)	0101	1620	<b>3,400</b>	ud	5	BOLSA	8431927095237

### CURVA 90° RLH

Ref.	Descripción	SERIE	GTV	€/ud	Unidad Venta	Unidad Embala.	Embalaje	Código EAN
55016016	CURVA 90° RLH DN16 GRIS	0101	1620	<b>7,480</b>	ud	25	BOLSA	8431927067685
55016020	CURVA 90° RLH DN20 GRIS	0101	1620	<b>8,870</b>	ud	25	BOLSA	8431927067692
55016025	CURVA 90° RLH DN25 GRIS	0101	1620	<b>10,200</b>	ud	25	BOLSA	8431927067708
55016032	CURVA 90° RLH DN32 GRIS	0101	1620	<b>18,350</b>	ud	10	BOLSA	8431927067715

**CURVA 90° RPVC**

Ref.	Descripción	SERIE	GTV	€/ud	Unidad Venta	Unidad Embala.	Embalaje	Código EAN
55072016	CODO RLH DN16 GRIS	0101	1620	<b>0,740</b>	ud	25	BOLSA	8431927067876
55072020	CODO RLH DN20 GRIS	0101	1620	<b>1,090</b>	ud	25	BOLSA	8431927067883
55072025	CODO RLH DN25 GRIS	0101	1620	<b>1,570</b>	ud	25	BOLSA	8431927067890
55072032	CODO RLH DN32 GRIS	0101	1620	<b>3,120</b>	ud	15	BOLSA	8431927067906

**TE REGISTRABLE DE 90 RLH**

Ref.	Descripción	SERIE	GTV	€/ud	Unidad Venta	Unidad Embala.	Embalaje	Código EAN
55082016	DERIVACION T RLH DN16 GRIS	0101	1620	<b>0,780</b>	ud	25	BOLSA	8431927068033
55082020	DERIVACION T RLH DN20 GRIS	0101	1620	<b>1,140</b>	ud	25	BOLSA	8431927068040
55082025	DERIVACION T RLH DN25 GRIS	0101	1620	<b>1,650</b>	ud	25	BOLSA	8431927068057
55082032	DERIVACION T RLH DN32 GRIS	0101	1620	<b>3,280</b>	ud	15	BOLSA	8431927068064

**CURVA FLEXIBLE RLH**

Ref.	Descripción	SERIE	GTV	€/ud	Unidad Venta	Unidad Embala.	Embalaje	Código EAN
55090016	CURVA FRLH DN16 GRIS	0101	1620	<b>2,010</b>	ud	20	BOLSA	8431927067951
55090020	CURVA FRLH DN20 GRIS	0101	1620	<b>2,960</b>	ud	20	BOLSA	8431927067968
55090025	CURVA FRLH DN25 GRIS	0101	1620	<b>5,100</b>	ud	10	BOLSA	8431927067975
55090032	CURVA FRLH DN32 GRIS	0101	1620	<b>7,490</b>	ud	10	BOLSA	8431927067982

## TUBOS RÍGIDOS PEMSA-PVC

**TUBO PEMSA RPVC RÍDIDO DE PVC**

Ref.	Descripción	SERIE	GTV	€/m	Unidad Venta	Unidad Embala.	Embalaje	Código EAN
13050116	TUBO RPVC1250+MANGUITO DN16 GRIS	0101	1515	<b>0,980</b>	m	57	PAQUETE	8431927067470
13050120	TUBO RPVC1250+MANGUITO DN20 GRIS	0101	1515	<b>1,310</b>	m	57	PAQUETE	8431927067487
13050125	TUBO RPVC1250+MANGUITO DN25 GRIS	0101	1515	<b>1,770</b>	m	57	PAQUETE	8431927067494
13050132	TUBO RPVC1250+MANGUITO DN32 GRIS	0101	1515	<b>2,490</b>	m	30	PAQUETE	8431927067500
13050140	TUBO RPVC1250+MANGUITO DN40 GRIS	0101	1515	<b>3,720</b>	m	30	PAQUETE	8431927067517
13050150	TUBO RPVC1250+MANGUITO DN50 GRIS	0101	1515	<b>5,110</b>	m	15	PAQUETE	8431927067524
13050163	TUBO RPVC1250+MANGUITO DN63 GRIS	0101	1515	<b>6,870</b>	m	15	PAQUETE	8431927067531

**TUBO PEMSA RPVC750 RÍDIDO DE PVC**

Ref.	Descripción	SERIE	GTV	€/m	Unidad Venta	Unidad Embala.	Embalaje	Código EAN
13060116	TUBO RPVC 750+MANGUITO DN16 GRIS	0101	1515	<b>0,620</b>	m	57	PAQUETE	8431927085337
13060120	TUBO RPVC 750+MANGUITO DN20 GRIS	0101	1515	<b>0,997</b>	m	57	PAQUETE	8431927085344
13060125	TUBO RPVC 750+MANGUITO DN25 GRIS	0101	1515	<b>1,398</b>	m	57	PAQUETE	8431927085351
13060132	TUBO RPVC 750+MANGUITO DN32 GRIS	0101	1515	<b>1,771</b>	m	30	PAQUETE	8431927085368
13060140	TUBO RPVC 750+MANGUITO DN40 GRIS	0101	1515	<b>2,907</b>	m	30	PAQUETE	8431927085375
13060150	TUBO RPVC 750+MANGUITO DN50 GRIS	0101	1515	<b>3,777</b>	m	15	PAQUETE	8431927085382
13060163	TUBO RPVC 750+MANGUITO DN63 GRIS	0101	1515	<b>5,720</b>	m	15	PAQUETE	8431927085399

**MANGUITO DE CONEXIÓN RPVC**

Ref.	Descripción	SERIE	GTV	€/ud	Unidad Venta	Unidad Embala.	Embalaje	Código EAN
55009016	MANGUITO RPVC DN16 GRIS	0101	1525	<b>0,550</b>	ud	19	BOLSA	8431927067616
55009020	MANGUITO RPVC DN20 GRIS	0101	1525	<b>0,570</b>	ud	19	BOLSA	8431927067623
55009025	MANGUITO RPVC DN25 GRIS	0101	1525	<b>0,620</b>	ud	19	BOLSA	8431927067630
55009032	MANGUITO RPVC DN32 GRIS	0101	1525	<b>0,650</b>	ud	10	BOLSA	8431927067647
55009040	MANGUITO RPVC DN40 GRIS	0101	1525	<b>1,490</b>	ud	10	BOLSA	8431927067654
55009050	MANGUITO RPVC DN50 GRIS	0101	1525	<b>2,100</b>	ud	5	BOLSA	8431927067661
55009063	MANGUITO RPVC DN63 GRIS	0101	1525	<b>2,380</b>	ud	5	BOLSA	8431927067678

**RACOR CAJA RPVC**

Ref.	Descripción	SERIE	GTV	€/ud	Unidad Venta	Unidad Embala.	Embalaje	Código EAN
55043016	RACOR CAJA RPVC M16 (DN16)	0101	1620	<b>0,370</b>	ud	19	BOLSA	8431927095176
55043020	RACOR CAJA RPVC M20 (DN20)	0101	1620	<b>0,475</b>	ud	19	BOLSA	8431927095183
55043025	RACOR CAJA RPVC M25 (DN25)	0101	1620	<b>0,630</b>	ud	19	BOLSA	8431927095190
55043032	RACOR CAJA RPVC M32 (DN32)	0101	1620	<b>0,805</b>	ud	10	BOLSA	8431927095206
55043040	RACOR CAJA RPVC M40 (DN40)	0101	1620	<b>0,995</b>	ud	10	BOLSA	8431927095213
55043050	RACOR CAJA RPVC M50 (DN50)	0101	1620	<b>1,345</b>	ud	5	BOLSA	8431927095220
55043063	RACOR CAJA RPVC M63 (DN63)	0101	1620	<b>2,750</b>	ud	5	BOLSA	8431927095237

### CURVA DE 90 RPVC

Ref.	Descripción	SERIE	GTV	€/ud	Unidad Venta	Unidad Embala.	Embalaje	Código EAN
55017016	CURVA 90° RPVC DN16 GRIS	0101	1525	<b>2,880</b>	ud	25	BOLSA	8431927067722
55017020	CURVA 90° RPVC DN20 GRIS	0101	1525	<b>3,420</b>	ud	25	BOLSA	8431927067739
55017025	CURVA 90° RPVC DN25 GRIS	0101	1525	<b>3,640</b>	ud	25	BOLSA	8431927067746
55017032	CURVA 90° RPVC DN32 GRIS	0101	1525	<b>4,450</b>	ud	10	BOLSA	8431927067753
55017040	CURVA 90° RPVC DN40 GRIS	0101	1525	<b>9,080</b>	ud	5	BOLSA	8431927093325
55017050	CURVA 90° RPVC DN50 GRIS	0101	1525	<b>17,920</b>	ud	5	BOLSA	8431927093332
55017063	CURVA 90° RPVC DN63 GRIS	0101	1525	<b>23,950</b>	ud	3	BOLSA	8431927093349

### CODO REGISTRABLE DE 90 RPVC

Ref.	Descripción	SERIE	GTV	€/ud	Unidad Venta	Unidad Embala.	Embalaje	Código EAN
55073016	CODO RPVC DN16 GRIS	0101	1525	<b>0,570</b>	ud	25	BOLSA	8431927067913
55073020	CODO RPVC DN20 GRIS	0101	1525	<b>0,820</b>	ud	25	BOLSA	8431927067920
55073025	CODO RPVC DN25 GRIS	0101	1525	<b>1,190</b>	ud	25	BOLSA	8431927067937
55073032	CODO RPVC DN32 GRIS	0101	1525	<b>2,390</b>	ud	15	BOLSA	8431927067944

### TE REGISTRABLE DE 90 RPVC

Ref.	Descripción	SERIE	GTV	€/ud	Unidad Venta	Unidad Embala.	Embalaje	Código EAN
55083016	DERIVACION T RPVC DN16 GRIS	0101	1525	<b>1,280</b>	ud	25	BOLSA	8431927068071
55083020	DERIVACION T RPVC DN20 GRIS	0101	1525	<b>1,510</b>	ud	25	BOLSA	8431927068088
55083025	DERIVACION T RPVC DN25 GRIS	0101	1525	<b>1,950</b>	ud	25	BOLSA	8431927068095
55083032	DERIVACION T RPVC DN32 GRIS	0101	1525	<b>2,300</b>	ud	15	BOLSA	8431927068101

### CURVA FLEXIBLE RPVC

Ref.	Descripción	SERIE	GTV	€/ud	Unidad Venta	Unidad Embala.	Embalaje	Código EAN
55091016	CURVA FRPVC DN16 GRIS	0101	1525	<b>1,340</b>	ud	20	BOLSA	8431927067999
55091020	CURVA FRPVC DN20 GRIS	0101	1525	<b>1,550</b>	ud	20	BOLSA	8431927068002
55091025	CURVA FRPVC DN25 GRIS	0101	1525	<b>2,050</b>	ud	10	BOLSA	8431927068019
55091032	CURVA FRPVC DN32 GRIS	0101	1525	<b>3,610</b>	ud	10	BOLSA	8431927068026

## TUBO CORRUGADO LIBRE DE HALÓGENOS

### TUBO CLH

Ref.	Descripción	SERIE	GTV	€/m	Unidad Venta	Unidad Embala.	Embalaje	Código EAN
10040216	TUBO CLH DN16 GRIS 7035	0101	1610	<b>0,720</b>	m	100	ROLLO	8431927080776
10040220	TUBO CLH DN20 GRIS 7035	0101	1610	<b>0,910</b>	m	100	ROLLO	8431927080783
10040225	TUBO CLH DN25 GRIS 7035	0101	1610	<b>1,390</b>	m	75	ROLLO	8431927080790
10040232	TUBO CLH DN32 GRIS 7035	0101	1610	<b>1,920</b>	m	50	ROLLO	8431927080806
10040240	TUBO CLH DN40 GRIS 7035	0101	1610	<b>3,140</b>	m	25	ROLLO	8431927080813
10040250	TUBO CLH DN50 GRIS 7035	0101	1610	<b>4,050</b>	m	25	ROLLO	8431927080820

### MANGUITO ACOPLAMIENTO CLH (tuerca incorporada)

Ref.	Descripción	SERIE	GTV	€/ud	Unidad Venta	Unidad Embala.	Embalaje	Código EAN
55007116	MANGUITO ACOPLAMIENTO CLH M16	0101	1620	<b>0,695</b>	ud	50	BOLSA	8431927082398
55007120	MANGUITO ACOPLAMIENTO CLH M20	0101	1620	<b>0,815</b>	ud	50	BOLSA	8431927082404
55007125	MANGUITO ACOPLAMIENTO CLH M25	0101	1620	<b>0,869</b>	ud	50	BOLSA	8431927082411

## TUBOS GRIS RAL 7035

### TUBO TM-PVC GRIS CLARO 7035

Ref.	Descripción	SERIE	GTV	€/m	Unidad Venta	Unidad Embala.	Embalaje	Código EAN
11060209	TUBO TM-PVC DN 9 GRIS C 7035	0101	1003	<b>3,584</b>	m	50	ROLLO	8431927087003
11060211	TUBO TM-PVC DN11 GRIS C 7035	0101	1003	<b>4,155</b>	m	50	ROLLO	8431927087010
11060213	TUBO TM-PVC DN13 GRIS C 7035	0101	1003	<b>4,491</b>	m	50	ROLLO	8431927087027
11060216	TUBO TM-PVC DN16 GRIS C 7035	0101	1003	<b>4,872</b>	m	50	ROLLO	8431927087034
11060221	TUBO TM-PVC DN21 GRIS C 7035	0101	1003	<b>6,619</b>	m	25	ROLLO	8431927087041
11060229	TUBO TM-PVC DN29 GRIS C 7035	0101	1003	<b>8,971</b>	m	25	ROLLO	8431927087058
11060236	TUBO TM-PVC DN36 GRIS C 7035	0101	1003	<b>12,690</b>	m	25	ROLLO	8431927087065
11060248	TUBO TM-PVC DN48 GRIS C 7035	0101	1003	<b>18,446</b>	m	20	ROLLO	8431927087072

**TUBO TFA GRIS CLARO 7035**

Ref.	Descripción	SERIE	GTV	€/m	Unidad Venta	Unidad Embala.	Embalaje	Código EAN
10011209	TUBO TFA DN 9 GRIS CLARO	0101	1001	<b>2,027</b>	m	25	ROLLO	8431927092410
10011211	TUBO TFA DN11 GRIS CLARO	0101	1001	<b>2,594</b>	m	25	ROLLO	8431927092427
10011213	TUBO TFA DN13 GRIS CLARO	0101	1001	<b>2,772</b>	m	25	ROLLO	8431927046307
10011216	TUBO TFA DN16 GRIS CLARO	0101	1001	<b>3,003</b>	m	25	ROLLO	8431927046314
10011221	TUBO TFA DN21 GRIS CLARO	0101	1001	<b>3,759</b>	m	25	ROLLO	8431927046321
10011229	TUBO TFA DN29 GRIS CLARO	0101	1001	<b>5,975</b>	m	25	ROLLO	8431927092434
10011236	TUBO TFA DN36 GRIS CLARO	0101	1001	<b>9,135</b>	m	25	ROLLO	8431927092441
10011248	TUBO TFA DN48 GRIS CLARO	0101	1001	<b>12,285</b>	m	20	ROLLO	8431927092458

**RACOR RGP GIRATORIO GRIS CLARO 7035**

Ref.	Descripción	SERIE	GTV	€/ud	Unidad Venta	Unidad Embala.	Embalaje	Código EAN
35012160	RACOR RGP GIRAT M16 (DN 9)GR C 7035	0101	1101	<b>1,690</b>	ud	100	CAJA	8431927046369
35012200	RACOR RGP GIRAT M20 (DN11)GR C 7035	0101	1101	<b>2,010</b>	ud	50	CAJA	8431927046376
35012201	RACOR RGP GIRAT M20 (DN13)GR C 7035	0101	1101	<b>2,180</b>	ud	50	CAJA	8431927046383
35012250	RACOR RGP GIRAT M25 (DN16)GR C 7035	0101	1101	<b>2,410</b>	ud	25	CAJA	8431927046406
35012320	RACOR RGP GIRAT M32 (DN21)GR C 7035	0101	1101	<b>4,280</b>	ud	25	CAJA	8431927046420
35012400	RACOR RGP GIRAT M40 (DN29)GR C 7035	0101	1101	<b>6,370</b>	ud	10	CAJA	8431927046444
35012500	RACOR RGP GIRAT M50 (DN36)GR C 7035	0101	1101	<b>14,570</b>	ud	8	CAJA	8431927046451
35012630	RACOR RGP GIRAT M63 (DN48)GR C 7035	0101	1101	<b>25,890</b>	ud	5	CAJA	8431927046468

## ELEMENTOS DE FIJACIÓN

**CLIP FIJACIÓN**

Ref.	Descripción	SERIE	GTV	€/ud	Unidad Venta	Unidad Embala.	Embalaje	Código EAN
55023016	CLIP DN16 GRIS	0101	1620	<b>0,240</b>	ud	100	CAJA	8431927091697
55023020	CLIP DN20 GRIS	0101	1620	<b>0,290</b>	ud	100	CAJA	8431927091703
55023025	CLIP DN25 GRIS	0101	1620	<b>0,310</b>	ud	100	CAJA	8431927091710
55023032	CLIP DN32 GRIS	0101	1620	<b>0,480</b>	ud	80	CAJA	8431927091727
55023040	CLIP DN40 GRIS	0101	1620	<b>0,660</b>	ud	30	CAJA	8431927091802
55023050	CLIP DN50 GRIS	0101	1620	<b>0,890</b>	ud	20	CAJA	8431927091819

**CLIP PRESION**

Ref.	Descripción	SERIE	GTV	€/ud	Unidad Venta	Unidad Embala.	Embalaje	Código EAN
55024012	CLIP PRESION DN12/20 GRIS	0101	1620	<b>0,600</b>	ud	50	CAJA	8431927091734
55024020	CLIP PRESION DN20/32 GRIS	0101	1620	<b>0,720</b>	ud	40	CAJA	8431927091741
55024032	CLIP PRESION DN32/50 GRIS	0101	1620	<b>1,560</b>	ud	20	CAJA	8431927091758

**BRIDA FIJACIÓN**

Ref.	Descripción	SERIE	GTV	€/ud	Unidad Venta	Unidad Embala.	Embalaje	Código EAN
55120032	BRIDA FIJACION DN 8/32 GRIS	0101	1620	<b>0,480</b>	ud	100	CAJA	8431927091772
55120063	BRIDA FIJACION DN16/63 GRIS	0101	1620	<b>0,840</b>	ud	50	CAJA	8431927091796

# SISTEMA METAL

## TUBOS RÍGIDOS DE ACERO ELECTROCINCADO

### TUBO RR



Ref.	Descripción	SERIE	GTV	€/m	Unidad Venta	Unidad Embala.	Embalaje	Código EAN
13030016	TUBO RR M16	0102	1510	<b>5,871</b>	m	51	PAQUETE	8431927019172
13030020	TUBO RR M20	0102	1510	<b>7,102</b>	m	51	PAQUETE	8431927019189
13030025	TUBO RR M25	0102	1510	<b>8,641</b>	m	30	PAQUETE	8431927019196
13030032	TUBO RR M32	0102	1510	<b>11,799</b>	m	21	PAQUETE	8431927019202
13030040	TUBO RR M40	0102	1510	<b>15,447</b>	m	15	PAQUETE	8431927019219
13030050	TUBO RR M50	0102	1510	<b>19,961</b>	m	15	PAQUETE	8431927019226
13030063	TUBO RR M63	0102	1510	<b>33,208</b>	m	9	PAQUETE	8431927019233

### TUBO RL



Ref.	Descripción	SERIE	GTV	€/m	Unidad Venta	Unidad Embala.	Embalaje	Código EAN
13040016	TUBO RL DN16	0102	1510	<b>4,868</b>	m	51	PAQUETE	8431927021748
13040020	TUBO RL DN20	0102	1510	<b>5,803</b>	m	51	PAQUETE	8431927021755
13040025	TUBO RL DN25	0102	1510	<b>7,228</b>	m	30	PAQUETE	8431927021762
13040032	TUBO RL DN32	0102	1510	<b>11,149</b>	m	21	PAQUETE	8431927021779
13040040	TUBO RL DN40	0102	1510	<b>14,558</b>	m	15	PAQUETE	8431927021786
13040050	TUBO RL DN50	0102	1510	<b>18,730</b>	m	15	PAQUETE	8431927021793
13040063	TUBO RL DN63	0102	1510	<b>24,111</b>	m	9	PAQUETE	8431927021809

## MANGUITOS Y ACCESORIOS

### MANGUITO RR



Ref.	Descripción	SERIE	GTV	€/ud	Unidad Venta	Unidad Embala.	Embalaje	Código EAN
55004016	MANGUITO RR M16	0102	1520	<b>1,380</b>	ud	50	CAJA	8431927026767
55004020	MANGUITO RR M20	0102	1520	<b>1,471</b>	ud	50	CAJA	8431927026774
55004025	MANGUITO RR M25	0102	1520	<b>1,653</b>	ud	50	CAJA	8431927026781
55004032	MANGUITO RR M32	0102	1520	<b>2,288</b>	ud	25	CAJA	8431927026798
55004040	MANGUITO RR M40	0102	1520	<b>2,871</b>	ud	20	CAJA	8431927026804
55004050	MANGUITO RR M50	0102	1520	<b>4,675</b>	ud	10	CAJA	8431927026811
55004063	MANGUITO RR M63	0102	1520	<b>7,875</b>	ud	6	CAJA	8431927026828

### MANGUITO RE



Ref.	Descripción	SERIE	GTV	€/ud	Unidad Venta	Unidad Embala.	Embalaje	Código EAN
55005016	MANGUITO RE M16	0102	1520	<b>1,436</b>	ud	50	CAJA	8431927026835
55005020	MANGUITO RE M20	0102	1520	<b>1,676</b>	ud	50	CAJA	8431927026842
55005025	MANGUITO RE M25	0102	1520	<b>2,052</b>	ud	50	CAJA	8431927026859
55005032	MANGUITO RE M32	0102	1520	<b>2,725</b>	ud	25	CAJA	8431927026866
55005040	MANGUITO RE M40	0102	1520	<b>3,990</b>	ud	20	CAJA	8431927026873
55005050	MANGUITO RE M50	0102	1520	<b>4,822</b>	ud	10	CAJA	8431927026880
55005063	MANGUITO RE M63	0102	1520	<b>8,664</b>	ud	6	CAJA	8431927026897

### MANGUITO RL



Ref.	Descripción	SERIE	GTV	€/ud	Unidad Venta	Unidad Embala.	Embalaje	Código EAN
55006016	MANGUITO RL DN16	0102	1520	<b>1,428</b>	ud	100	CAJA	8431927026903
55006020	MANGUITO RL DN20	0102	1520	<b>1,512</b>	ud	50	CAJA	8431927026910
55006025	MANGUITO RL DN25	0102	1520	<b>1,859</b>	ud	25	CAJA	8431927026927
55006032	MANGUITO RL DN32	0102	1520	<b>2,331</b>	ud	20	CAJA	8431927026934
55006040	MANGUITO RL DN40	0102	1520	<b>3,465</b>	ud	12	CAJA	8431927026941
55006050	MANGUITO RL DN50	0102	1520	<b>4,841</b>	ud	6	CAJA	8431927026958
55006063	MANGUITO RL DN63	0102	1520	<b>8,537</b>	ud	3	CAJA	8431927026965

### MANGUITO ACOPLAMIENTO



Ref.	Descripción	SERIE	GTV	€/ud	Unidad Venta	Unidad Embala.	Embalaje	Código EAN
55007016	MANGUITO ACOPLAMIENTO M16	0102	1520	<b>2,972</b>	ud	50	CAJA	8431927026972
55007020	MANGUITO ACOPLAMIENTO M20	0102	1520	<b>3,295</b>	ud	50	CAJA	8431927026989
55007025	MANGUITO ACOPLAMIENTO M25	0102	1520	<b>3,497</b>	ud	25	CAJA	8431927026996
55007032	MANGUITO ACOPLAMIENTO M32	0102	1520	<b>4,064</b>	ud	25	CAJA	8431927027009
55007040	MANGUITO ACOPLAMIENTO M40	0102	1520	<b>5,282</b>	ud	15	CAJA	8431927027016
55007050	MANGUITO ACOPLAMIENTO M50	0102	1520	<b>6,741</b>	ud	6	CAJA	8431927027023
55007063	MANGUITO ACOPLAMIENTO M63	0102	1520	<b>10,679</b>	ud	6	CAJA	8431927027030



**CURVA 90° RR**

Ref.	Descripción	SERIE	GTV	€/ud	Unidad Venta	Unidad Embala.	Embalaje	Código EAN
55014016	CURVA 90° RR M16	0102	1520	<b>5,754</b>	ud	10	PAQUETE	8431927027047
55014020	CURVA 90° RR M20	0102	1520	<b>5,951</b>	ud	10	PAQUETE	8431927027054
55014025	CURVA 90° RR M25	0102	1520	<b>6,357</b>	ud	10	PAQUETE	8431927027061
55014032	CURVA 90° RR M32	0102	1520	<b>9,257</b>	ud	10	PAQUETE	8431927027078
55014040	CURVA 90° RR M40	0102	1520	<b>13,850</b>	ud	5	PAQUETE	8431927027085
55014050	CURVA 90° RR M50	0102	1520	<b>26,083</b>	ud	3	PAQUETE	8431927027092
55014063	CURVA 90° RR M63	0102	1520	<b>40,641</b>	ud	3	PAQUETE	8431927027108

**CURVA 90° RL**

Ref.	Descripción	SERIE	GTV	€/ud	Unidad Venta	Unidad Embala.	Embalaje	Código EAN
55015016	CURVA 90° RL DN16	0102	1520	<b>3,462</b>	ud	10	PAQUETE	8431927027115
55015020	CURVA 90° RL DN20	0102	1520	<b>3,945</b>	ud	10	PAQUETE	8431927027122
55015025	CURVA 90° RL DN25	0102	1520	<b>4,140</b>	ud	10	PAQUETE	8431927027139
55015032	CURVA 90° RL DN32	0102	1520	<b>6,118</b>	ud	10	PAQUETE	8431927027146
55015040	CURVA 90° RL DN40	0102	1520	<b>9,798</b>	ud	5	PAQUETE	8431927027153
55015050	CURVA 90° RL DN50	0102	1520	<b>17,388</b>	ud	5	PAQUETE	8431927027160
55015063	CURVA 90° RL DN63	0102	1520	<b>24,369</b>	ud	3	PAQUETE	8431927027177

**TERMINAL TUBO**

Ref.	Descripción	SERIE	GTV	€/ud	Unidad Venta	Unidad Embala.	Embalaje	Código EAN
55111016	TERMINAL TUBO DN16 RAL7035	0102	1520	<b>0,825</b>	ud	CAJA	100	8431927091611
55111020	TERMINAL TUBO DN20 RAL7035	0102	1520	<b>0,878</b>	ud	CAJA	100	8431927091628
55111025	TERMINAL TUBO DN25 RAL7035	0102	1520	<b>0,997</b>	ud	CAJA	100	8431927091635
55111032	TERMINAL TUBO DN32 RAL7035	0102	1520	<b>1,419</b>	ud	CAJA	50	8431927091642
55111040	TERMINAL TUBO DN40 RAL7035	0102	1520	<b>1,617</b>	ud	CAJA	50	8431927091659
55111050	TERMINAL TUBO DN50 RAL7035	0102	1520	<b>1,960</b>	ud	CAJA	25	8431927091666
55111063	TERMINAL TUBO DN63 RAL7035	0102	1520	<b>2,284</b>	ud	CAJA	20	8431927091673

**DERIVACION TR**

Ref.	Descripción	SERIE	GTV	€/ud	Unidad Venta	Unidad Embala.	Embalaje	Código EAN
55080016	DERIVACIÓN TR M16	0102	1520	<b>13,266</b>	ud	10	CAJA	8431927027337
55080020	DERIVACIÓN TR M20	0102	1520	<b>14,571</b>	ud	10	CAJA	8431927027344
55080025	DERIVACIÓN TR M25	0102	1520	<b>16,638</b>	ud	8	CAJA	8431927027351
55080032	DERIVACIÓN TR M32	0102	1520	<b>20,956</b>	ud	2	CAJA	8431927027368
55080040	DERIVACIÓN TR M40	0102	1520	<b>30,019</b>	ud	2	CAJA	8431927027375
55080050	DERIVACIÓN TR M50	0102	1520	<b>44,022</b>	ud	1	CAJA	8431927027382

**DERIVACION TL**

Ref.	Descripción	SERIE	GTV	€/ud	Unidad Venta	Unidad Embala.	Embalaje	Código EAN
55081016	DERIVACIÓN TL DN16	0102	1520	<b>13,134</b>	ud	10	CAJA	8431927027399
55081020	DERIVACIÓN TL DN20	0102	1520	<b>15,060</b>	ud	10	CAJA	8431927027405
55081025	DERIVACIÓN TL DN25	0102	1520	<b>16,463</b>	ud	8	CAJA	8431927027412
55081032	DERIVACIÓN TL DN32	0102	1520	<b>20,761</b>	ud	2	CAJA	8431927027429
55081040	DERIVACIÓN TL DN40	0102	1520	<b>30,296</b>	ud	2	CAJA	8431927027436
55081050	DERIVACIÓN TL DN50	0102	1520	<b>44,453</b>	ud	1	CAJA	8431927027443

**CODO R**

Ref.	Descripción	SERIE	GTV	€/ud	Unidad Venta	Unidad Embala.	Embalaje	Código EAN
55070016	CODO R M16	0102	1520	<b>11,834</b>	ud	25	CAJA	8431927027214
55070020	CODO R M20	0102	1520	<b>12,765</b>	ud	20	CAJA	8431927027221
55070025	CODO R M25	0102	1520	<b>13,628</b>	ud	12	CAJA	8431927027238
55070032	CODO R M32	0102	1520	<b>18,113</b>	ud	4	CAJA	8431927027245
55070040	CODO R M40	0102	1520	<b>25,626</b>	ud	4	CAJA	8431927027252
55070050	CODO R M50	0102	1520	<b>35,347</b>	ud	2	CAJA	8431927027269

**CODO L**

Ref.	Descripción	SERIE	GTV	€/ud	Unidad Venta	Unidad Embala.	Embalaje	Código EAN
55071016	CODO L DN16	0102	1520	<b>11,231</b>	ud	20	CAJA	8431927027276
55071020	CODO L DN20	0102	1520	<b>12,662</b>	ud	20	CAJA	8431927027283
55071025	CODO L DN25	0102	1520	<b>13,501</b>	ud	12	CAJA	8431927027290
55071032	CODO L DN32	0102	1520	<b>17,220</b>	ud	4	CAJA	8431927027306
55071040	CODO L DN40	0102	1520	<b>24,948</b>	ud	4	CAJA	8431927027313
55071050	CODO L DN50	0102	1520	<b>35,000</b>	ud	2	CAJA	8431927027320

## Racor RMT



Ref.	Descripción	SERIE	GTV	€/ud	Unidad Venta	Unidad Embala.	Embalaje	Código EAN
37031160	RACOR RMT M16 (DN16)	0102	1520	<b>2,507</b>	ud	100	CAJA	8431927015068
37031201	RACOR RMT M20 (DN20)	0102	1520	<b>3,071</b>	ud	100	CAJA	8431927015075
37031250	RACOR RMT M25 (DN25)	0102	1520	<b>4,083</b>	ud	50	CAJA	8431927015082
37031320	RACOR RMT M32 (DN32)	0102	1520	<b>7,510</b>	ud	25	CAJA	8431927015099
37031400	RACOR RMT M40 (DN40)	0102	1520	<b>11,086</b>	ud	20	CAJA	8431927015105
37031500	RACOR RMT M50 (DN50)	0102	1520	<b>20,298</b>	ud	10	CAJA	8431927015112
37031630	RACOR RMT M63 (DN63)	0102	1520	<b>38,192</b>	ud	5	CAJA	8431927015129

# TUBOS RÍGIDOS DE ACERO GALVANIZADO EN CALIENTE

## TUBO RLGC



Ref.	Descripción	SERIE	GTV	€/m	Unidad Venta	Unidad Embala.	Embalaje	Código EAN
13040116	TUBO RLGC DN16	0102	1510	<b>8,547</b>	m	30	PAQUETE	8431927091062
13040120	TUBO RLGC DN20	0102	1510	<b>10,237</b>	m	30	PAQUETE	8431927091079
13040125	TUBO RLGC DN25	0102	1510	<b>13,398</b>	m	30	PAQUETE	8431927091086
13040132	TUBO RLGC DN32	0102	1510	<b>17,101</b>	m	21	PAQUETE	8431927091093
13040140	TUBO RLGC DN40	0102	1510	<b>21,638</b>	m	15	PAQUETE	8431927091109
13040150	TUBO RLGC DN50	0102	1510	<b>26,239</b>	m	15	PAQUETE	8431927091116
13040163	TUBO RLGC DN63	0102	1510	<b>39,857</b>	m	15	PAQUETE	8431927091123

## TUBO RRG



Ref.	Descripción	SERIE	GTV	€/m	Unidad Venta	Unidad Embala.	Embalaje	Código EAN
13030116	TUBO RRG M16	0102	1510	<b>11,729</b>	m	30	PAQUETE	8431927091031
13030120	TUBO RRG M20	0102	1510	<b>13,706</b>	m	30	PAQUETE	8431927087683
13030125	TUBO RRG M25	0102	1510	<b>17,535</b>	m	30	PAQUETE	8431927087690
13030132	TUBO RRG M32	0102	1510	<b>22,775</b>	m	21	PAQUETE	8431927087706
13030140	TUBO RRG M40	0102	1510	<b>28,620</b>	m	15	PAQUETE	8431927087713
13030150	TUBO RRG M50	0102	1510	<b>36,078</b>	m	15	PAQUETE	8431927091048
13030163	TUBO RRG M63	0102	1510	<b>48,776</b>	m	15	PAQUETE	8431927091055

## MANGUITO RLGC



Ref.	Descripción	SERIE	GTV	€/ud	Unidad Venta	Unidad Embala.	Embalaje	Código EAN
55006116	MANGUITO RLGC DN16	0102	1520	<b>1,496</b>	ud	25	CAJA	8431927091161
55006120	MANGUITO RLGC DN20	0102	1520	<b>1,709</b>	ud	50	CAJA	8431927091178
55006125	MANGUITO RLGC DN25	0102	1520	<b>2,187</b>	ud	50	CAJA	8431927091185
55006132	MANGUITO RLGC DN32	0102	1520	<b>2,999</b>	ud	50	CAJA	8431927091192
55006140	MANGUITO RLGC DN40	0102	1520	<b>4,805</b>	ud	25	CAJA	8431927091208
55006150	MANGUITO RLGC DN50	0102	1520	<b>6,411</b>	ud	10	CAJA	8431927091215
55006163	MANGUITO RLGC DN63	0102	1520	<b>9,675</b>	ud	5	CAJA	8431927091222

## MANGUITO RRG



Ref.	Descripción	SERIE	GTV	€/m	Unidad Venta	Unidad Embala.	Embalaje	Código EAN
55004116	MANGUITO RRG M16	0102	1520	<b>1,834</b>	ud	25	CAJA	8431927091130
55004120	MANGUITO RRG M20	0102	1520	<b>2,051</b>	ud	50	CAJA	8431927087645
55004125	MANGUITO RRG M25	0102	1520	<b>2,870</b>	ud	50	CAJA	8431927087652
55004132	MANGUITO RRG M32	0102	1520	<b>3,827</b>	ud	50	CAJA	8431927087669
55004140	MANGUITO RRG M40	0102	1520	<b>5,162</b>	ud	25	CAJA	8431927087676
55004150	MANGUITO RRG M50	0102	1520	<b>7,941</b>	ud	10	CAJA	8431927091147
55004163	MANGUITO RRG M63	0102	1520	<b>10,861</b>	ud	5	CAJA	8431927091154

## CURVA RLGC



Ref.	Descripción	SERIE	GTV	€/m	Unidad Venta	Unidad Embala.	Embalaje	Código EAN
55015116	CURVA 90° RLGC DN16	0102	1520	<b>7,486</b>	ud	15	PAQUETE	8431927091307
55015120	CURVA 90° RLGC DN20	0102	1520	<b>7,610</b>	ud	25	PAQUETE	8431927091314
55015125	CURVA 90° RLGC DN25	0102	1520	<b>8,356</b>	ud	25	PAQUETE	8431927091321
55015132	CURVA 90° RLGC DN32	0102	1520	<b>11,933</b>	ud	20	PAQUETE	8431927091338
55015140	CURVA 90° RLGC DN40	0102	1520	<b>19,159</b>	ud	15	PAQUETE	8431927091345
55015150	CURVA 90° RLGC DN50	0102	1520	<b>27,550</b>	ud	5	PAQUETE	8431927091352
55015163	CURVA 90° RLGC DN63	0102	1520	<b>39,534</b>	ud	3	PAQUETE	8431927091369

**CURVA RRG**

Ref.	Descripción	SERIE	GTV	€/ud	Unidad Venta	Unidad Embala.	Embalaje	Código EAN
55014116	CURVA 90° RRG M16	0102	1520	<b>8,858</b>	ud	15	PAQUETE	8431927091239
55014120	CURVA 90° RRG M20	0102	1520	<b>10,027</b>	ud	25	PAQUETE	8431927091246
55014125	CURVA 90° RRG M25	0102	1520	<b>11,164</b>	ud	25	PAQUETE	8431927091253
55014132	CURVA 90° RRG M32	0102	1520	<b>14,807</b>	ud	20	PAQUETE	8431927091260
55014140	CURVA 90° RRG M40	0102	1520	<b>21,479</b>	ud	15	PAQUETE	8431927091277
55014150	CURVA 90° RRG M50	0102	1520	<b>37,538</b>	ud	5	PAQUETE	8431927091284
55014163	CURVA 90° RRG M63	0102	1520	<b>51,491</b>	ud	3	PAQUETE	8431927091291

**ABRAZADERA RGC**

Ref.	Descripción	SERIE	GTV	€/ud	Unidad Venta	Unidad Embala.	Embalaje	Código EAN
55032116	ABRAZADERA RGC DN16	0102	1520	<b>1,646</b>	ud	100	CAJA	8431927091475
55032120	ABRAZADERA RGC DN20	0102	1520	<b>1,687</b>	ud	100	CAJA	8431927091482
55032125	ABRAZADERA RGC DN25	0102	1520	<b>1,781</b>	ud	100	CAJA	8431927091499
55032132	ABRAZADERA RGC DN32	0102	1520	<b>2,070</b>	ud	100	CAJA	8431927091505
55032140	ABRAZADERA RGC DN40	0102	1520	<b>2,782</b>	ud	50	CAJA	8431927091512
55032150	ABRAZADERA RGC DN50	0102	1520	<b>3,837</b>	ud	50	CAJA	8431927091529
55032163	ABRAZADERA RGC DN63	0102	1520	<b>6,424</b>	ud	50	CAJA	8431927091536

**ABRAZADERA PIE RGC**

Ref.	Descripción	SERIE	GTV	€/ud	Unidad Venta	Unidad Embala.	Embalaje	Código EAN
55033116	ABRAZADERA PIE RGC DN16	0102	1520	<b>1,808</b>	ud	50	CAJA	8431927091543
55033120	ABRAZADERA PIE RGC DN20	0102	1520	<b>1,855</b>	ud	50	CAJA	8431927091550
55033125	ABRAZADERA PIE RGC DN25	0102	1520	<b>1,962</b>	ud	50	CAJA	8431927091567
55033132	ABRAZADERA PIE RGC DN32	0102	1520	<b>2,278</b>	ud	25	CAJA	8431927091574
55033140	ABRAZADERA PIE RGC DN40	0102	1520	<b>3,058</b>	ud	25	CAJA	8431927091581
55033150	ABRAZADERA PIE RGC DN50	0102	1520	<b>4,220</b>	ud	25	CAJA	8431927091598
55033163	ABRAZADERA PIE RGC DN63	0102	1520	<b>7,063</b>	ud	20	CAJA	8431927091604

## TUBOS RÍGIDOS DE ALUMINIO

**TUBO RAL**

Ref.	Descripción	SERIE	GTV	€/m	Unidad Venta	Unidad Embala.	Embalaje	Código EAN
13020016	TUBO RAL DN16	0102	1510	<b>6,923</b>	m	15	PAQUETE	8431927026545
13020020	TUBO RAL DN20	0102	1510	<b>8,860</b>	m	15	PAQUETE	8431927026552
13020025	TUBO RAL DN25	0102	1510	<b>11,428</b>	m	15	PAQUETE	8431927026569
13020032	TUBO RAL DN32	0102	1510	<b>15,836</b>	m	15	PAQUETE	8431927026576
13020040	TUBO RAL DN40	0102	1510	<b>21,400</b>	m	15	PAQUETE	8431927026583
13020050	TUBO RAL DN50	0102	1510	<b>26,429</b>	m	15	PAQUETE	8431927026590
13020063	TUBO RAL DN63	0102	1510	<b>41,516</b>	m	15	PAQUETE	8431927026606

**MANGUITO RAL**

Ref.	Descripción	SERIE	GTV	€/ud	Unidad Venta	Unidad Embala.	Embalaje	Código EAN
55002016	MANGUITO RAL DN16	0102	1520	<b>3,179</b>	ud	50	CAJA	8431927026613
55002020	MANGUITO RAL DN20	0102	1520	<b>3,729</b>	ud	50	CAJA	8431927026620
55002025	MANGUITO RAL DN25	0102	1520	<b>4,477</b>	ud	50	CAJA	8431927026637
55002032	MANGUITO RAL DN32	0102	1520	<b>5,489</b>	ud	50	CAJA	8431927026644
55002040	MANGUITO RAL DN40	0102	1520	<b>6,776</b>	ud	20	CAJA	8431927026651
55002050	MANGUITO RAL DN50	0102	1520	<b>10,692</b>	ud	20	CAJA	8431927026668
55002063	MANGUITO RAL DN63	0102	1520	<b>13,057</b>	ud	15	CAJA	8431927026675

**CURVA 90° RAL**

Ref.	Descripción	SERIE	GTV	€/ud	Unidad Venta	Unidad Embala.	Embalaje	Código EAN
55012016	CURVA 90° RAL DN 16	0102	1520	<b>18,533</b>	ud	5	PAQUETE	8431927027597
55012020	CURVA 90° RAL DN 20	0102	1520	<b>20,265</b>	ud	5	PAQUETE	8431927027603
55012025	CURVA 90° RAL DN 25	0102	1520	<b>21,956</b>	ud	5	PAQUETE	8431927027610
55012032	CURVA 90° RAL DN 32	0102	1520	<b>26,450</b>	ud	5	PAQUETE	8431927027627
55012040	CURVA 90° RAL DN 40	0102	1520	<b>30,282</b>	ud	5	PAQUETE	8431927027634
55012050	CURVA 90° RAL DN 50	0102	1520	<b>36,288</b>	ud	5	PAQUETE	8431927027641
55012063	CURVA 90° RAL DN 63	0102	1520	<b>46,977</b>	ud	3	PAQUETE	8431927027658

### CLIP RAL



Ref.	Descripción	SERIE	GTV	€/ud	Unidad Venta	Unidad Embala.	Embalaje	Código EAN
55022016	CLIP RAL DN16	0102	1520	<b>1,310</b>	ud	50	CAJA	8431927091376
55022020	CLIP RAL DN20	0102	1520	<b>1,431</b>	ud	50	CAJA	8431927091383
55022025	CLIP RAL DN25	0102	1520	<b>1,525</b>	ud	50	CAJA	8431927091390
55022032	CLIP RAL DN32	0102	1520	<b>1,740</b>	ud	50	CAJA	8431927091406
55022040	CLIP RAL DN40	0102	1520	<b>2,023</b>	ud	25	CAJA	8431927091413

### ABRAZADERA PIE RAL



Ref.	Descripción	SERIE	GTV	€/ud	Unidad Venta	Unidad Embala.	Embalaje	Código EAN
55031016	ABRAZADERA PIE RAL DN16	0102	1520	<b>1,996</b>	ud	50	CAJA	8431927091420
55031020	ABRAZADERA PIE RAL DN20	0102	1520	<b>2,090</b>	ud	50	CAJA	8431927091437
55031025	ABRAZADERA PIE RAL DN25	0102	1520	<b>2,191</b>	ud	50	CAJA	8431927091444
55031032	ABRAZADERA PIE RAL DN32	0102	1520	<b>2,238</b>	ud	25	CAJA	8431927091451
55031040	ABRAZADERA PIE RAL DN40	0102	1520	<b>2,547</b>	ud	25	CAJA	8431927091468

## TUBOS RÍGIDOS DE ACERO INOXIDABLE

### TUBO RINOX



Ref.	Descripción	SERIE	GTV	€/m	Unidad Venta	Unidad Embala.	Embalaje	Código EAN
13021016	TUBO RINOX DN16	0102	1510	Consultar	m	15	PAQUETE	8431927091826
13021020	TUBO RINOX DN20	0102	1510	Consultar	m	15	PAQUETE	8431927026682
13021025	TUBO RINOX DN25	0102	1510	Consultar	m	15	PAQUETE	8431927026699
13021032	TUBO RINOX DN32	0102	1510	Consultar	m	15	PAQUETE	8431927026705
13021040	TUBO RINOX DN40	0102	1510	Consultar	m	9	PAQUETE	8431927026712
13021050	TUBO RINOX DN50	0102	1510	Consultar	m	9	PAQUETE	8431927091833

### MANGUITO RINOX



Ref.	Descripción	SERIE	GTV	€/ud	Unidad Venta	Unidad Embala.	Embalaje	Código EAN
55003016	MANGUITO RINOX DN16	0102	1520	Consultar	ud	25	CAJA	8431927091840
55003020	MANGUITO RINOX DN20	0102	1520	Consultar	ud	25	CAJA	8431927026729
55003025	MANGUITO RINOX DN25	0102	1520	Consultar	ud	25	CAJA	8431927026736
55003032	MANGUITO RINOX DN32	0102	1520	Consultar	ud	10	CAJA	8431927026743
55003040	MANGUITO RINOX DN40	0102	1520	Consultar	ud	10	CAJA	8431927026750
55003050	MANGUITO RINOX DN50	0102	1520	Consultar	ud	10	CAJA	8431927091857

### CURVA 90° RINOX



Ref.	Descripción	SERIE	GTV	€/ud	Unidad Venta	Unidad Embala.	Embalaje	Código EAN
55013016	CURVA 90° RINOX DN16	0102	1520	Consultar	ud	15	PAQUETE	8431927091864
55013020	CURVA 90° RINOX DN20	0102	1520	Consultar	ud	25	PAQUETE	8431927027696
55013025	CURVA 90° RINOX DN25	0102	1520	Consultar	ud	25	PAQUETE	8431927027702
55013032	CURVA 90° RINOX DN32	0102	1520	Consultar	ud	20	PAQUETE	8431927027719
55013040	CURVA 90° RINOX DN40	0102	1520	Consultar	ud	15	PAQUETE	8431927027726
55013050	CURVA 90° RINOX DN50	0102	1520	Consultar	ud	5	PAQUETE	8431927091871

### ABRAZADERA RINOX



Ref.	Descripción	SERIE	GTV	€/ud	Unidad Venta	Unidad Embala.	Embalaje	Código EAN
55034016	ABRAZADERA RINOX DN16	0102	1520	Consultar	ud	100	CAJA	8431927091888
55034020	ABRAZADERA RINOX DN20	0102	1520	Consultar	ud	100	CAJA	8431927091895
55034025	ABRAZADERA RINOX DN25	0102	1520	Consultar	ud	100	CAJA	8431927091901
55034032	ABRAZADERA RINOX DN32	0102	1520	Consultar	ud	100	CAJA	8431927091918
55034040	ABRAZADERA RINOX DN40	0102	1520	Consultar	ud	50	CAJA	8431927091925
55034050	ABRAZADERA RINOX DN50	0102	1520	Consultar	ud	50	CAJA	8431927091932

### ABRAZADERA PIE RINOX



Ref.	Descripción	SERIE	GTV	€/ud	Unidad Venta	Unidad Embala.	Embalaje	Código EAN
55035016	ABRAZADERA PIE RINOX DN16	0102	1520	Consultar	ud	50	CAJA	8431927091949
55035020	ABRAZADERA PIE RINOX DN20	0102	1520	Consultar	ud	50	CAJA	8431927091956
55035025	ABRAZADERA PIE RINOX DN25	0102	1520	Consultar	ud	50	CAJA	8431927091963
55035032	ABRAZADERA PIE RINOX DN32	0102	1520	Consultar	ud	50	CAJA	8431927091970
55035040	ABRAZADERA PIE RINOX DN40	0102	1520	Consultar	ud	25	CAJA	8431927091987
55035050	ABRAZADERA PIE RINOX DN50	0102	1520	Consultar	ud	25	CAJA	8431927091994

# SISTEMA FLEXIBL

## TUBOS FLEXIBLES PEMSA-CLÁSICO

### TUBO TFA GRIS



Ref.	Descripción	SERIE	GTV	€/m	Unidad Venta	Unidad Embala.	Embalaje	Código EAN
10011007	TUBO TFA DN 7 GRIS	0103	1001	<b>1,617</b>	m	25	ROLLO	8431927018311
10011009	TUBO TFA DN 9 GRIS	0103	1001	<b>1,712</b>	m	25	ROLLO	8431927018328
10011011	TUBO TFA DN11 GRIS	0103	1001	<b>2,195</b>	m	25	ROLLO	8431927018335
10011013	TUBO TFA DN13 GRIS	0103	1001	<b>2,431</b>	m	25	ROLLO	8431927018342
10011016	TUBO TFA DN16 GRIS	0103	1001	<b>2,678</b>	m	25	ROLLO	8431927018359
10011021	TUBO TFA DN21 GRIS	0103	1001	<b>3,296</b>	m	25	ROLLO	8431927018366
10011029	TUBO TFA DN29 GRIS	0103	1001	<b>4,715</b>	m	25	ROLLO	8431927018373
10011036	TUBO TFA DN36 GRIS	0103	1001	<b>6,388</b>	m	25	ROLLO	8431927018380
10011048	TUBO TFA DN48 GRIS	0103	1001	<b>9,198</b>	m	20	ROLLO	8431927018397

### TUBO TFA NEGRO (BAJO PEDIDO)



Ref.	Descripción	SERIE	GTV	€/m	Unidad Venta	Unidad Embala.	Embalaje	Código EAN
10011507	TUBO TFA DN 7 NEGR	0103	1001	<b>1,648</b>	m	25	ROLLO	8431927018915
10011509	TUBO TFA DN 9 NEGR	0103	1001	<b>1,712</b>	m	25	ROLLO	8431927018922
10011511	TUBO TFA DN11 NEGR	0103	1001	<b>2,195</b>	m	25	ROLLO	8431927018939
10011513	TUBO TFA DN13 NEGR	0103	1001	<b>2,431</b>	m	25	ROLLO	8431927018946
10011516	TUBO TFA DN16 NEGR	0103	1001	<b>2,678</b>	m	25	ROLLO	8431927018953
10011521	TUBO TFA DN21 NEGR	0103	1001	<b>3,296</b>	m	25	ROLLO	8431927018960
10011529	TUBO TFA DN29 NEGR	0103	1001	<b>4,715</b>	m	25	ROLLO	8431927018977
10011536	TUBO TFA DN36 NEGR	0103	1001	<b>6,388</b>	m	25	ROLLO	8431927018984
10011548	TUBO TFA DN48 NEGR	0103	1001	<b>9,198</b>	m	20	ROLLO	8431927018991

### TUBO TM



Ref.	Descripción	SERIE	GTV	€/m	Unidad Venta	Unidad Embala.	Embalaje	Código EAN
11010107	TUBO TM DN 7x50m	0103	1004	<b>1,927</b>	m	50	ROLLO	8431927000422
11010109	TUBO TM DN 9x50m	0103	1004	<b>2,189</b>	m	50	ROLLO	8431927000439
11010111	TUBO TM DN11x50m	0103	1004	<b>2,964</b>	m	50	ROLLO	8431927000446
11010113	TUBO TM DN13x50m	0103	1004	<b>3,295</b>	m	50	ROLLO	8431927000453
11010116	TUBO TM DN16x50m	0103	1004	<b>3,562</b>	m	50	ROLLO	8431927000460
11010021	TUBO TM DN21	0103	1004	<b>4,469</b>	m	25	ROLLO	8431927000477
11010029	TUBO TM DN29	0103	1004	<b>6,451</b>	m	25	ROLLO	8431927000484
11010036	TUBO TM DN36	0103	1004	<b>8,019</b>	m	25	ROLLO	8431927000491
11010048	TUBO TM DN48	0103	1004	<b>10,371</b>	m	20	ROLLO	8431927000507

### TUBO TM-PVC



Ref.	Descripción	SERIE	GTV	€/m	Unidad Venta	Unidad Embala.	Embalaje	Código EAN
11020107	TUBO TM-PVC DN 7x50m	0103	1003	<b>2,576</b>	m	50	ROLLO	8431927000514
11020109	TUBO TM-PVC DN 9x50m	0103	1003	<b>3,147</b>	m	50	ROLLO	8431927000521
11020111	TUBO TM-PVC DN11x50m	0103	1003	<b>3,674</b>	m	50	ROLLO	8431927000538
11020113	TUBO TM-PVC DN13x50m	0103	1003	<b>4,010</b>	m	50	ROLLO	8431927000545
11020116	TUBO TM-PVC DN16x50m	0103	1003	<b>4,346</b>	m	50	ROLLO	8431927000552
11020021	TUBO TM-PVC DN21	0103	1003	<b>5,914</b>	m	25	ROLLO	8431927000569
11020029	TUBO TM-PVC DN29	0103	1003	<b>7,941</b>	m	25	ROLLO	8431927000576
11020036	TUBO TM-PVC DN36	0103	1003	<b>11,133</b>	m	25	ROLLO	8431927000583
11020048	TUBO TM-PVC DN48	0103	1003	<b>15,752</b>	m	20	ROLLO	8431927000590

### TUBO ECOFLEX



Ref.	Descripción	SERIE	GTV	€/m	Unidad Venta	Unidad Embala.	Embalaje	Código EAN
11060107	TUBO ECOFLEX DN 7X50 m	0103	1002	<b>2,218</b>	m	50	ROLLO	8431927017475
11060109	TUBO ECOFLEX DN 9X50 m	0103	1002	<b>2,556</b>	m	50	ROLLO	8431927017482
11060111	TUBO ECOFLEX DN11X50 m	0103	1002	<b>3,105</b>	m	50	ROLLO	8431927017499
11060113	TUBO ECOFLEX DN13X50 m	0103	1002	<b>3,445</b>	m	50	ROLLO	8431927017505
11060116	TUBO ECOFLEX DN16X50 m	0103	1002	<b>3,795</b>	m	50	ROLLO	8431927017512
11060021	TUBO ECOFLEX DN21	0103	1002	<b>4,697</b>	m	25	ROLLO	8431927000712
11060029	TUBO ECOFLEX DN29	0103	1002	<b>7,034</b>	m	25	ROLLO	8431927000729
11060036	TUBO ECOFLEX DN36	0103	1002	<b>9,776</b>	m	25	ROLLO	8431927000736
11060048	TUBO ECOFLEX DN48	0103	1002	<b>12,750</b>	m	20	ROLLO	8431927000743

# RACORES

## RACOR P PG



Ref.	Descripción	SERIE	GTV	€/ud	Unidad Venta	Unidad Embala.	Embalaje	Código EAN
30010007	RACOR P PG 7 (DN 7)	0103	1101	<b>0,510</b>	ud	100	CAJA	8431927001795
30010009	RACOR P PG 9 (DN 9)	0103	1101	<b>0,540</b>	ud	100	CAJA	8431927001801
30010011	RACOR P PG11 (DN11)	0103	1101	<b>0,560</b>	ud	50	CAJA	8431927001818
30010013	RACOR P PG13 (DN13)	0103	1101	<b>0,620</b>	ud	50	CAJA	8431927001825
30010016	RACOR P PG16 (DN16)	0103	1101	<b>0,730</b>	ud	25	CAJA	8431927001832
30010021	RACOR P PG21 (DN21)	0103	1101	<b>1,040</b>	ud	25	CAJA	8431927001849
30010029	RACOR P PG29 (DN29)	0103	1101	<b>1,750</b>	ud	10	CAJA	8431927001856
30010036	RACOR P PG36 (DN36)	0103	1101	<b>3,000</b>	ud	8	CAJA	8431927001863
30010048	RACOR P PG48 (DN48)	0103	1101	<b>3,750</b>	ud	5	CAJA	8431927001870

## RACOR P Métrica



Ref.	Descripción	SERIE	GTV	€/ud	Unidad Venta	Unidad Embala.	Embalaje	Código EAN
30011160	RACOR P M16 (DN 9)	0103	1101	<b>0,540</b>	ud	100	CAJA	8431927001894
30011200	RACOR P M20 (DN11)	0103	1101	<b>0,560</b>	ud	50	CAJA	8431927001900
30011201	RACOR P M20 (DN13)	0103	1101	<b>0,620</b>	ud	50	CAJA	8431927001917
30011250	RACOR P M25 (DN16)	0103	1101	<b>0,730</b>	ud	25	CAJA	8431927001924
30011320	RACOR P M32 (DN21)	0103	1101	<b>1,040</b>	ud	25	CAJA	8431927001931
30011400	RACOR P M40 (DN29)	0103	1101	<b>1,720</b>	ud	10	CAJA	8431927001948
30011500	RACOR P M50 (DN36)	0103	1101	<b>3,000</b>	ud	8	CAJA	8431927001955
30011630	RACOR P M63 (DN48)	0103	1101	<b>3,860</b>	ud	5	CAJA	8431927001962

## RACOR RGP GIRATORIO PG



Ref.	Descripción	SERIE	GTV	€/ud	Unidad Venta	Unidad Embala.	Embalaje	Código EAN
35010007	RACOR RGP GIRATORIO PG 7 (DN 7)	0103	1101	<b>1,565</b>	ud	100	CAJA	8431927004208
35010009	RACOR RGP GIRATORIO PG 9 (DN 9)	0103	1101	<b>1,575</b>	ud	100	CAJA	8431927004215
35010011	RACOR RGP GIRATORIO PG11 (DN11)	0103	1101	<b>1,934</b>	ud	50	CAJA	8431927004222
35010013	RACOR RGP GIRATORIO PG13 (DN13)	0103	1101	<b>2,136</b>	ud	50	CAJA	8431927004239
35010016	RACOR RGP GIRATORIO PG16 (DN16)	0103	1101	<b>2,242</b>	ud	25	CAJA	8431927004246
35010021	RACOR RGP GIRATORIO PG21 (DN21)	0103	1101	<b>4,034</b>	ud	25	CAJA	8431927004253
35010029	RACOR RGP GIRATORIO PG29 (DN29)	0103	1101	<b>6,078</b>	ud	10	CAJA	8431927004260
35010036	RACOR RGP GIRATORIO PG36 (DN36)	0103	1101	<b>12,779</b>	ud	8	CAJA	8431927004277
35010048	RACOR RGP GIRATORIO PG48 (DN48)	0103	1101	<b>25,770</b>	ud	5	CAJA	8431927004284

## RACOR RGP GIRATORIO Métrica



Ref.	Descripción	SERIE	GTV	€/ud	Unidad Venta	Unidad Embala.	Embalaje	Código EAN
35011160	RACOR RGP GIRATORIO M16 (DN 9)	0103	1101	<b>1,681</b>	ud	100	CAJA	8431927004307
35011200	RACOR RGP GIRATORIO M20 (DN11)	0103	1101	<b>1,906</b>	ud	50	CAJA	8431927004314
35011201	RACOR RGP GIRATORIO M20 (DN13)	0103	1101	<b>2,095</b>	ud	50	CAJA	8431927004321
35011250	RACOR RGP GIRATORIO M25 (DN16)	0103	1101	<b>2,162</b>	ud	25	CAJA	8431927004338
35011320	RACOR RGP GIRATORIO M32 (DN21)	0103	1101	<b>3,822</b>	ud	25	CAJA	8431927004345
35011400	RACOR RGP GIRATORIO M40 (DN29)	0103	1101	<b>6,069</b>	ud	10	CAJA	8431927004352
35011500	RACOR RGP GIRATORIO M50 (DN36)	0103	1101	<b>12,779</b>	ud	8	CAJA	8431927004369
35011630	RACOR RGP GIRATORIO M63 (DN48)	0103	1101	<b>25,770</b>	ud	5	CAJA	8431927004376

## RACOR RGM GIRATORIO PG



Ref.	Descripción	SERIE	GTV	€/ud	Unidad Venta	Unidad Embala.	Embalaje	Código EAN
35020007	RACOR RGM GIRATORIO PG 7 (DN 7)	0103	1101	<b>2,410</b>	ud	100	CAJA	8431927004383
35020009	RACOR RGM GIRATORIO PG 9 (DN 9)	0103	1101	<b>2,425</b>	ud	100	CAJA	8431927004390
35020011	RACOR RGM GIRATORIO PG11 (DN11)	0103	1101	<b>3,025</b>	ud	50	CAJA	8431927004406
35020013	RACOR RGM GIRATORIO PG13 (DN13)	0103	1101	<b>3,358</b>	ud	50	CAJA	8431927004413
35020016	RACOR RGM GIRATORIO PG16 (DN16)	0103	1101	<b>3,532</b>	ud	25	CAJA	8431927004420
35020021	RACOR RGM GIRATORIO PG21 (DN21)	0103	1101	<b>6,164</b>	ud	25	CAJA	8431927004437
35020029	RACOR RGM GIRATORIO PG29 (DN29)	0103	1101	<b>9,427</b>	ud	10	CAJA	8431927004444
35020036	RACOR RGM GIRATORIO PG36 (DN36)	0103	1101	<b>19,769</b>	ud	8	CAJA	8431927004451
35020048	RACOR RGM GIRATORIO PG48 (DN48)	0103	1101	<b>39,885</b>	ud	5	CAJA	8431927004468

**RACOR RGM GIRATORIO Métrica**

Ref.	Descripción	SERIE	GTV	€/ud	Unidad Venta	Unidad Embala.	Embalaje	Código EAN
35021120	RACOR RGM GIRATORIO M12 (DN 7)	0103	1101	<b>2,754</b>	ud	100	CAJA	8431927004475
35021160	RACOR RGM GIRATORIO M16 (DN 9)	0103	1101	<b>2,985</b>	ud	100	CAJA	8431927004482
35021200	RACOR RGM GIRATORIO M20 (DN11)	0103	1101	<b>3,675</b>	ud	50	CAJA	8431927004499
35021201	RACOR RGM GIRATORIO M20 (DN13)	0103	1101	<b>3,985</b>	ud	50	CAJA	8431927004505
35021250	RACOR RGM GIRATORIO M25 (DN16)	0103	1101	<b>4,375</b>	ud	25	CAJA	8431927004512
35021320	RACOR RGM GIRATORIO M32 (DN21)	0103	1101	<b>6,275</b>	ud	25	CAJA	8431927004529
35021400	RACOR RGM GIRATORIO M40 (DN29)	0103	1101	<b>9,427</b>	ud	10	CAJA	8431927004536
35021500	RACOR RGM GIRATORIO M50 (DN36)	0103	1101	<b>18,909</b>	ud	8	CAJA	8431927004543
35021630	RACOR RGM GIRATORIO M63 (DN48)	0103	1101	<b>38,940</b>	ud	5	CAJA	8431927004550

**RACOR RM PG**

Ref.	Descripción	SERIE	GTV	€/ud	Unidad Venta	Unidad Embala.	Embalaje	Código EAN
37020007	RACOR RM PG 7 (DN 7)	0103	1102	<b>2,410</b>	ud	100	CAJA	8431927004727
37020009	RACOR RM PG 9 (DN 9)	0103	1102	<b>2,425</b>	ud	100	CAJA	8431927004734
37020011	RACOR RM PG11 (DN11)	0103	1102	<b>2,976</b>	ud	100	CAJA	8431927004741
37020013	RACOR RM PG13 (DN13)	0103	1102	<b>3,356</b>	ud	50	CAJA	8431927004758
37020016	RACOR RM PG16 (DN16)	0103	1102	<b>3,530</b>	ud	50	CAJA	8431927004765
37020021	RACOR RM PG21 (DN21)	0103	1102	<b>6,132</b>	ud	25	CAJA	8431927004772
37020029	RACOR RM PG29 (DN29)	0103	1102	<b>9,354</b>	ud	20	CAJA	8431927004789
37020036	RACOR RM PG36 (DN36)	0103	1102	<b>19,362</b>	ud	10	CAJA	8431927004796
37020048	RACOR RM PG48 (DN48)	0103	1102	<b>40,150</b>	ud	5	CAJA	8431927004802

**RACOR RM Métrica**

Ref.	Descripción	SERIE	GTV	€/ud	Unidad Venta	Unidad Embala.	Embalaje	Código EAN
37021120	RACOR RM M12 (DN 7)	0103	1102	<b>2,547</b>	ud	100	CAJA	8431927004819
37021160	RACOR RM M16 (DN 9)	0103	1102	<b>2,587</b>	ud	100	CAJA	8431927004826
37021200	RACOR RM M20 (DN11)	0103	1102	<b>2,951</b>	ud	100	CAJA	8431927004833
37021201	RACOR RM M20 (DN13)	0103	1102	<b>3,327</b>	ud	50	CAJA	8431927004840
37021250	RACOR RM M25 (DN16)	0103	1102	<b>3,328</b>	ud	50	CAJA	8431927004857
37021320	RACOR RM M32 (DN21)	0103	1102	<b>4,991</b>	ud	25	CAJA	8431927004864
37021400	RACOR RM M40 (DN29)	0103	1102	<b>9,601</b>	ud	20	CAJA	8431927004871
37021500	RACOR RM M50 (DN36)	0103	1102	<b>19,264</b>	ud	10	CAJA	8431927004888
37021630	RACOR RM M63 (DN48)	0103	1102	<b>39,652</b>	ud	5	CAJA	8431927004895

**RACOR RMM Métrica**

Ref.	Descripción	SERIE	GTV	€/ud	Unidad Venta	Unidad Embala.	Embalaje	Código EAN
37026120	RACOR RMM M12 (DN 7)	0103	1102	<b>3,275</b>	ud	100	CAJA	Consultar
37026160	RACOR RMM M16 (DN 9)	0103	1102	<b>3,655</b>	ud	100	CAJA	Consultar
37026200	RACOR RMM M20 (DN11)	0103	1102	<b>4,225</b>	ud	100	CAJA	Consultar
37026201	RACOR RMM M20 (DN13)	0103	1102	<b>4,577</b>	ud	50	CAJA	Consultar
37026250	RACOR RMM M25 (DN16)	0103	1102	<b>5,075</b>	ud	50	CAJA	Consultar
37026320	RACOR RMM M32 (DN21)	0103	1102	<b>7,925</b>	ud	25	CAJA	Consultar
37026400	RACOR RMM M40 (DN29)	0103	1102	<b>13,455</b>	ud	20	CAJA	Consultar
37026500	RACOR RMM M50 (DN36)	0103	1102	<b>30,155</b>	ud	10	CAJA	Consultar
37026630	RACOR RMM M63 (DN48)	0103	1102	<b>54,785</b>	ud	5	CAJA	Consultar

**RACOR RMM PG**

Ref.	Descripción	SERIE	GTV	€/ud	Unidad Venta	Unidad Embala.	Embalaje	Código EAN
37025007	RACOR RMM PG 7 (DN 7)	0103	1102	<b>3,385</b>	ud	100	CAJA	Consultar
37025009	RACOR RMM PG 9 (DN 9)	0103	1102	<b>4,255</b>	ud	100	CAJA	Consultar
37025011	RACOR RMM PG11 (DN11)	0103	1102	<b>4,465</b>	ud	100	CAJA	Consultar
37025013	RACOR RMM PG13 (DN13)	0103	1102	<b>4,855</b>	ud	50	CAJA	Consultar
37025016	RACOR RMM PG16 (DN16)	0103	1102	<b>7,951</b>	ud	50	CAJA	Consultar
37025021	RACOR RMM PG21 (DN21)	0103	1102	<b>13,545</b>	ud	25	CAJA	Consultar
37025029	RACOR RMM PG29 (DN29)	0103	1102	<b>28,458</b>	ud	20	CAJA	Consultar
37025036	RACOR RMM PG36 (DN36)	0103	1102	<b>49,948</b>	ud	10	CAJA	Consultar
37025048	RACOR RMM PG48 (DN48)	0103	1102	<b>54,775</b>	ud	5	CAJA	Consultar

**RACOR RMH Métrica**

Ref.	Descripción	SERIE	GTV	€/ud	Unidad Venta	Unidad Embala.	Embalaje	Código EAN
37041120	RACOR RMH M12 (DN7)	0103	1102	<b>2,495</b>	ud	100	CAJA	8431927096104
37041160	RACOR RMH M16 (DN9)	0103	1102	<b>3,091</b>	ud	100	CAJA	8431927096111
37041200	RACOR RMH M20 (DN11)	0103	1102	<b>3,640</b>	ud	100	CAJA	8431927096128
37041201	RACOR RMH M20 (DN13)	0103	1102	<b>4,116</b>	ud	50	CAJA	8431927096135
37041250	RACOR RMH M25 (DN16)	0103	1102	<b>4,675</b>	ud	50	CAJA	8431927096142
37041320	RACOR RMH M32 (DN21)	0103	1102	<b>7,174</b>	ud	25	CAJA	8431927096159
37041400	RACOR RMH M40 (DN29)	0103	1102	<b>11,467</b>	ud	20	CAJA	8431927096166
37041500	RACOR RMH M50 (DN36)	0103	1102	<b>23,006</b>	ud	10	CAJA	8431927096173
37041630	RACOR RMH M63 (DN48)	0103	1102	<b>47,354</b>	ud	5	CAJA	8431927096180

**RACOR RMMH MÉTRICA**

Ref.	Descripción	SERIE	GTV	€/ud	Unidad Venta	Unidad Embala.	Embalaje	Código EAN
37046120	RACOR RMMH M12 (DN7)	0103	1102	<b>3,379</b>	ud	100	CAJA	Consultar
37046160	RACOR RMMH M16 (DN9)	0103	1102	<b>4,463</b>	ud	100	CAJA	Consultar
37046200	RACOR RMMH M20 (DN11)	0103	1102	<b>5,068</b>	ud	100	CAJA	Consultar
37046201	RACOR RMMH M20 (DN13)	0103	1102	<b>5,731</b>	ud	50	CAJA	Consultar
37046250	RACOR RMMH M25 (DN16)	0103	1102	<b>6,611</b>	ud	50	CAJA	Consultar
37046320	RACOR RMMH M32 (DN21)	0103	1102	<b>10,462</b>	ud	25	CAJA	Consultar
37046400	RACOR RMMH M40 (DN29)	0103	1102	<b>16,855</b>	ud	20	CAJA	Consultar
37046500	RACOR RMMH M50 (DN36)	0103	1102	<b>27,575</b>	ud	10	CAJA	Consultar
37046630	RACOR RMMH M63 (DN48)	0103	1102	<b>65,220</b>	ud	5	CAJA	Consultar

## ACCESORIOS

**CASQUILLO RP PG GRIS**

Ref.	Descripción	SERIE	GTV	€/ud	Unidad Venta	Unidad Embala.	Embalaje	Código EAN
37003107	CASQUILLO RP PG 7 (DN 7)	0103	1102	<b>0,730</b>	ud	100	CAJA	8431927012296
37003109	CASQUILLO RP PG 9 (DN 9)	0103	1102	<b>0,790</b>	ud	100	CAJA	8431927012302
37003111	CASQUILLO RP PG11 (DN11)	0103	1102	<b>0,880</b>	ud	100	CAJA	8431927012319
37003113	CASQUILLO RP PG13 (DN13)	0103	1102	<b>0,910</b>	ud	50	CAJA	8431927012326
37003116	CASQUILLO RP PG16 (DN16)	0103	1102	<b>0,970</b>	ud	50	CAJA	8431927012333
37003121	CASQUILLO RP PG21 (DN21)	0103	1102	<b>1,140</b>	ud	25	CAJA	8431927012340
37003129	CASQUILLO RP PG29 (DN29)	0103	1102	<b>1,820</b>	ud	20	CAJA	8431927012357
37003136	CASQUILLO RP PG36 (DN36)	0103	1102	<b>1,990</b>	ud	10	CAJA	8431927012364
37003148	CASQUILLO RP PG48 (DN48)	0103	1102	<b>2,490</b>	ud	5	CAJA	8431927012371

**ABRAZADERA I**

Ref.	Descripción	SERIE	GTV	€/ud	Unidad Venta	Unidad Embala.	Embalaje	Código EAN
39095000	ABRAZADERA I DN 7	0103	1108	<b>1,712</b>	ud	100	BOLSA	8431927005380
39095100	ABRAZADERA I DN10	0103	1108	<b>1,765</b>	ud	100	BOLSA	8431927005397
39095200	ABRAZADERA I DN12	0103	1108	<b>1,825</b>	ud	100	BOLSA	8431927005403
39095400	ABRAZADERA I DN17	0103	1108	<b>2,075</b>	ud	100	BOLSA	8431927005410
39095500	ABRAZADERA I DN23	0103	1108	<b>2,183</b>	ud	50	BOLSA	8431927005427
39095600	ABRAZADERA I DN29	0103	1108	<b>2,540</b>	ud	30	BOLSA	8431927005434
39095700	ABRAZADERA I DN36	0103	1108	<b>3,017</b>	ud	20	BOLSA	8431927005441
39095800	ABRAZADERA I DN48	0103	1108	<b>4,360</b>	ud	20	BOLSA	8431927005458



# SISTEMA PEMSAFLEX

## TUBOS FLEXIBLES PEMSAFLEX

### TUBO FLEXIBLE LG-PA GRIS



Ref.	Descripción	SERIE	GTV	€/m	Unidad Venta	Unidad Embala.	Embalaje	Código EAN
10042007	TUBO FLEXIBLE LG-PA DN 7 GRIS	0104	1006	<b>0,774</b>	m	50	ROLLO	8431927017291
10042010	TUBO FLEXIBLE LG-PA DN10 GRIS	0104	1006	<b>0,912</b>	m	50	ROLLO	8431927017307
10042012	TUBO FLEXIBLE LG-PA DN12 GRIS	0104	1006	<b>1,124</b>	m	50	ROLLO	8431927017314
10042014	TUBO FLEXIBLE LG-PA DN14 GRIS	0104	1006	<b>1,700</b>	m	50	ROLLO	8431927017321
10042017	TUBO FLEXIBLE LG-PA DN17 GRIS	0104	1006	<b>1,855</b>	m	50	ROLLO	8431927017338
10042023	TUBO FLEXIBLE LG-PA DN23 GRIS	0104	1006	<b>2,809</b>	m	50	ROLLO	8431927017345
10042029	TUBO FLEXIBLE LG-PA DN29 GRIS	0104	1006	<b>3,742</b>	m	25	ROLLO	8431927017352
10042036	TUBO FLEXIBLE LG-PA DN36 GRIS	0104	1006	<b>4,834</b>	m	25	ROLLO	8431927017369
10042048	TUBO FLEXIBLE LG-PA DN48 GRIS	0104	1006	<b>6,858</b>	m	20	ROLLO	8431927017376

### TUBO FLEXIBLE LG-PA NEGRO



Ref.	Descripción	SERIE	GTV	€/m	Unidad Venta	Unidad Embala.	Embalaje	Código EAN
10043007	TUBO FLEXIBLE LG-PA DN 7 NEGR	0104	1006	<b>0,774</b>	m	50	ROLLO	8431927017383
10043010	TUBO FLEXIBLE LG-PA DN10 NEGR	0104	1006	<b>0,912</b>	m	50	ROLLO	8431927017390
10043012	TUBO FLEXIBLE LG-PA DN12 NEGR	0104	1006	<b>1,124</b>	m	50	ROLLO	8431927017406
10043014	TUBO FLEXIBLE LG-PA DN14 NEGR	0104	1006	<b>1,700</b>	m	50	ROLLO	8431927017413
10043017	TUBO FLEXIBLE LG-PA DN17 NEGR	0104	1006	<b>1,855</b>	m	50	ROLLO	8431927017420
10043023	TUBO FLEXIBLE LG-PA DN23 NEGR	0104	1006	<b>2,809</b>	m	50	ROLLO	8431927017437
10043029	TUBO FLEXIBLE LG-PA DN29 NEGR	0104	1006	<b>3,742</b>	m	25	ROLLO	8431927017444
10043036	TUBO FLEXIBLE LG-PA DN36 NEGR	0104	1006	<b>4,834</b>	m	25	ROLLO	8431927017451
10043048	TUBO FLEXIBLE LG-PA DN48 NEGR	0104	1006	<b>6,858</b>	m	20	ROLLO	8431927017468

### TUBO FLEXIBLE ST-PA GRIS



Ref.	Descripción	SERIE	GTV	€/m	Unidad Venta	Unidad Embala.	Embalaje	Código EAN
10040007	TUBO FLEXIBLE ST-PA DN 7 GRIS	0104	1006	<b>1,175</b>	m	50	ROLLO	8431927017116
10040010	TUBO FLEXIBLE ST-PA DN10 GRIS	0104	1006	<b>1,225</b>	m	50	ROLLO	8431927017123
10040012	TUBO FLEXIBLE ST-PA DN12 GRIS	0104	1006	<b>1,482</b>	m	50	ROLLO	8431927017130
10040014	TUBO FLEXIBLE ST-PA DN14 GRIS	0104	1006	<b>2,009</b>	m	50	ROLLO	8431927017147
10040017	TUBO FLEXIBLE ST-PA DN17 GRIS	0104	1006	<b>2,298</b>	m	50	ROLLO	8431927017154
10040023	TUBO FLEXIBLE ST-PA DN23 GRIS	0104	1006	<b>3,488</b>	m	50	ROLLO	8431927017161
10040029	TUBO FLEXIBLE ST-PA DN29 GRIS	0104	1006	<b>4,346</b>	m	25	ROLLO	8431927017178
10040036	TUBO FLEXIBLE ST-PA DN36 GRIS	0104	1006	<b>5,607</b>	m	25	ROLLO	8431927017185
10040048	TUBO FLEXIBLE ST-PA DN48 GRIS	0104	1006	<b>8,487</b>	m	20	ROLLO	8431927017192

### TUBO FLEXIBLE ST-PA NEGRO



Ref.	Descripción	SERIE	GTV	€/m	Unidad Venta	Unidad Embala.	Embalaje	Código EAN
10041007	TUBO FLEXIBLE ST-PA DN 7 NEGR	0104	1006	<b>1,025</b>	m	50	ROLLO	8431927017208
10041010	TUBO FLEXIBLE ST-PA DN10 NEGR	0104	1006	<b>1,120</b>	m	50	ROLLO	8431927017215
10041012	TUBO FLEXIBLE ST-PA DN12 NEGR	0104	1006	<b>1,390</b>	m	50	ROLLO	8431927017222
10041014	TUBO FLEXIBLE ST-PA DN14 NEGR	0104	1006	<b>2,009</b>	m	50	ROLLO	8431927017239
10041017	TUBO FLEXIBLE ST-PA DN17 NEGR	0104	1006	<b>2,297</b>	m	50	ROLLO	8431927017246
10041023	TUBO FLEXIBLE ST-PA DN23 NEGR	0104	1006	<b>3,460</b>	m	50	ROLLO	8431927017253
10041029	TUBO FLEXIBLE ST-PA DN29 NEGR	0104	1006	<b>4,346</b>	m	25	ROLLO	8431927017260
10041036	TUBO FLEXIBLE ST-PA DN36 NEGR	0104	1006	<b>5,607</b>	m	25	ROLLO	8431927017277
10041048	TUBO FLEXIBLE ST-PA DN48 NEGR	0104	1006	<b>8,464</b>	m	20	ROLLO	8431927017284

### TUBO FLEXIBLE RF-PA GRIS. PRODUCTO DESCATALOGADO CONSULTAR DISPONIBILIDAD.



Ref.	Descripción	SERIE	GTV	€/m	Unidad Venta	Unidad Embala.	Embalaje	Código EAN
10044007	TUBO FLEXIBLE RF-PA DN 7 GRIS	0104	1006	<b>4,590</b>	m	100	ROLLO	8431927022332
10044010	TUBO FLEXIBLE RF-PA DN10 GRIS	0104	1006	<b>4,851</b>	m	50	ROLLO	8431927022349
10044012	TUBO FLEXIBLE RF-PA DN12 GRIS	0104	1006	<b>6,427</b>	m	50	ROLLO	8431927022356
10044017	TUBO FLEXIBLE RF-PA DN17 GRIS	0104	1006	<b>11,309</b>	m	50	ROLLO	8431927022363
10044023	TUBO FLEXIBLE RF-PA DN23 GRIS	0104	1006	<b>17,067</b>	m	50	ROLLO	8431927022370
10044029	TUBO FLEXIBLE RF-PA DN29 GRIS	0104	1006	<b>19,920</b>	m	50	ROLLO	8431927022387
10044036	TUBO FLEXIBLE RF-PA DN36 GRIS	0104	1006	<b>34,536</b>	m	30	ROLLO	8431927022394
10044048	TUBO FLEXIBLE RF-PA DN48 GRIS	0104	1006	<b>38,069</b>	m	30	ROLLO	8431927022400

**TUBO FLEXIBLE RF-PA NEGRO PRODUCTO DESCATALOGADO CONSULTAR DISPONIBILIDAD.**

Ref.	Descripción	SERIE	GTV	€/m	Unidad Venta	Unidad Embala.	Embalaje	Código EAN
10045007	TUBO FLEXIBLE RF-PA DN 7 NEGR	0104	1006	<b>4,460</b>	m	100	ROLLO	8431927022417
10045010	TUBO FLEXIBLE RF-PA DN10 NEGR	0104	1006	<b>4,851</b>	m	50	ROLLO	8431927022424
10045012	TUBO FLEXIBLE RF-PA DN12 NEGR	0104	1006	<b>6,427</b>	m	50	ROLLO	8431927022431
10045017	TUBO FLEXIBLE RF-PA DN17 NEGR	0104	1006	<b>11,309</b>	m	50	ROLLO	8431927022448
10045023	TUBO FLEXIBLE RF-PA DN23 NEGR	0104	1006	<b>17,067</b>	m	50	ROLLO	8431927022455
10045029	TUBO FLEXIBLE RF-PA DN29 NEGR	0104	1006	<b>19,920</b>	m	50	ROLLO	8431927022462
10045036	TUBO FLEXIBLE RF-PA DN36 NEGR	0104	1006	<b>34,536</b>	m	30	ROLLO	8431927022479
10045048	TUBO FLEXIBLE RF-PA DN48 NEGR	0104	1006	<b>38,069</b>	m	30	ROLLO	8431927022486

**TUBO FLEXIBLE RB-PA GRIS**

Ref.	Descripción	SERIE	GTV	€/m	Unidad Venta	Unidad Embala.	Embalaje	Código EAN
10046007	TUBO FLEXIBLE RB-PA DN 7 GRIS	0104	1006	<b>4,779</b>	m	100	ROLLO	8431927040688
10046010	TUBO FLEXIBLE RB-PA DN10 GRIS	0104	1006	<b>4,903</b>	m	50	ROLLO	8431927040695
10046012	TUBO FLEXIBLE RB-PA DN12 GRIS	0104	1006	<b>6,726</b>	m	50	ROLLO	8431927040701
10046017	TUBO FLEXIBLE RB-PA DN17 GRIS	0104	1006	<b>10,455</b>	m	50	ROLLO	8431927016386
10046023	TUBO FLEXIBLE RB-PA DN23 GRIS	0104	1006	<b>14,863</b>	m	50	ROLLO	8431927016393
10046029	TUBO FLEXIBLE RB-PA DN29 GRIS	0104	1006	<b>18,828</b>	m	50	ROLLO	8431927016409
10046036	TUBO FLEXIBLE RB-PA DN36 GRIS	0104	1006	<b>24,246</b>	m	30	ROLLO	8431927022493
10046048	TUBO FLEXIBLE RB-PA DN48 GRIS	0104	1006	<b>34,443</b>	m	30	ROLLO	8431927022509
10046052	TUBO FLEXIBLE RB-PA DN52 GRIS	0104	1006	<b>50,872</b>	m	30	ROLLO	8431927022516
10046070	TUBO FLEXIBLE RB-PA DN70 GRIS	0104	1006	<b>92,041</b>	m	30	ROLLO	8431927022523

**TUBO FLEXIBLE RB-PA NEGRO (BAJO PEDIDO)**

Ref.	Descripción	SERIE	GTV	€/m	Unidad Venta	Unidad Embala.	Embalaje	Código EAN
10047007	TUBO FLEXIBLE RB-PA DN 7 NEGR	0104	1006	<b>4,779</b>	m	100	ROLLO	8431927040718
10047010	TUBO FLEXIBLE RB-PA DN10 NEGR	0104	1006	<b>4,903</b>	m	50	ROLLO	8431927040725
10047012	TUBO FLEXIBLE RB-PA DN12 NEGR	0104	1006	<b>6,726</b>	m	50	ROLLO	8431927040732
10047017	TUBO FLEXIBLE RB-PA DN17 NEGR	0104	1006	<b>10,455</b>	m	50	ROLLO	8431927040749
10047023	TUBO FLEXIBLE RB-PA DN23 NEGR	0104	1006	<b>14,863</b>	m	50	ROLLO	8431927040756
10047029	TUBO FLEXIBLE RB-PA DN29 NEGR	0104	1006	<b>18,828</b>	m	50	ROLLO	8431927040763
10047036	TUBO FLEXIBLE RB-PA DN36 NEGR	0104	1006	<b>24,246</b>	m	30	ROLLO	8431927022530
10047048	TUBO FLEXIBLE RB-PA DN48 NEGR	0104	1006	<b>34,443</b>	m	30	ROLLO	8431927022547
10047052	TUBO FLEXIBLE RB-PA DN52 NEGR	0104	1006	<b>50,872</b>	m	30	ROLLO	8431927022554
10047070	TUBO FLEXIBLE RB-PA DN70 NEGR	0104	1006	<b>92,041</b>	m	10	ROLLO	8431927022561

**TUBO FLEXIBLE RB-PU NEGRO (BAJO PEDIDO)**

Ref.	Descripción	SERIE	GTV	€/m	Unidad Venta	Unidad Embala.	Embalaje	Código EAN
10048017	TUBO FLEXIBLE RB-PU DN17 NEGR	0104	1006	<b>14,966</b>	m	50	ROLLO	8431927022578
10048023	TUBO FLEXIBLE RB-PU DN23 NEGR	0104	1006	<b>15,635</b>	m	50	ROLLO	8431927022585
10048029	TUBO FLEXIBLE RB-PU DN29 NEGR	0104	1006	<b>21,414</b>	m	50	ROLLO	8431927022592
10048036	TUBO FLEXIBLE RB-PU DN36 NEGR	0104	1006	<b>30,076</b>	m	30	ROLLO	8431927022608
10048048	TUBO FLEXIBLE RB-PU DN48 NEGR	0104	1020	<b>39,037</b>	m	30	ROLLO	8431927022615
10048052	TUBO FLEXIBLE RB-PU DN52 NEGR	0104	1020	<b>52,242</b>	m	30	ROLLO	8431927022622
10048070	TUBO FLEXIBLE RB-PU DN70 NEGR	0104	1020	<b>93,699</b>	m	30	ROLLO	8431927022639

# ACCESORIOS MONTAJE DE TUBOS PEMSAFLEX

## TERMINAL PROTECTOR



Ref.	Descripción	SERIE	GTV	€/ud	Unidad Venta	Unidad Embala.	Embalaje	Código EAN
39098100	TERMINAL PROTECTOR DN10	0104	1108	<b>0,515</b>	ud	50	BOLSA	8431927025609
39098200	TERMINAL PROTECTOR DN12	0104	1108	<b>0,515</b>	ud	50	BOLSA	8431927025616
39098400	TERMINAL PROTECTOR DN17	0104	1108	<b>0,546</b>	ud	50	BOLSA	8431927025623
39098500	TERMINAL PROTECTOR DN23	0104	1108	<b>0,999</b>	ud	50	BOLSA	8431927025630
39098600	TERMINAL PROTECTOR DN29	0104	1108	<b>1,257</b>	ud	30	BOLSA	8431927025647
39098700	TERMINAL PROTECTOR DN36	0104	1108	<b>1,936</b>	ud	10	BOLSA	8431927025654
39098800	TERMINAL PROTECTOR DN48	0104	1108	<b>2,606</b>	ud	10	BOLSA	8431927025661

## SOPORTE TUBO GRIS



Ref.	Descripción	SERIE	GTV	€/ud	Unidad Venta	Unidad Embala.	Embalaje	Código EAN
31095000	SOPORTE TUBO DN 7 GRIS	0104	1108	<b>0,680</b>	ud	100	BOLSA	8431927002877
31095100	SOPORTE TUBO DN10 GRIS	0104	1108	<b>0,608</b>	ud	100	BOLSA	8431927002884
31095200	SOPORTE TUBO DN12 GRIS	0104	1108	<b>0,649</b>	ud	50	BOLSA	8431927002891
31095400	SOPORTE TUBO DN17 GRIS	0104	1108	<b>0,773</b>	ud	50	BOLSA	8431927002907
31095500	SOPORTE TUBO DN23 GRIS	0104	1108	<b>1,607</b>	ud	50	BOLSA	8431927002914
31095600	SOPORTE TUBO DN29 GRIS	0104	1108	<b>2,060</b>	ud	30	BOLSA	8431927002921
31095700	SOPORTE TUBO DN36 GRIS	0104	1108	<b>2,750</b>	ud	20	BOLSA	8431927002938
31095800	SOPORTE TUBO DN48 GRIS	0104	1108	<b>3,636</b>	ud	20	BOLSA	8431927002945

## SOPORTE TUBO NEGRO



Ref.	Descripción	SERIE	GTV	€/ud	Unidad Venta	Unidad Embala.	Embalaje	Código EAN
32095000	SOPORTE TUBO DN 7 NEGR	0104	1108	<b>0,680</b>	ud	100	BOLSA	8431927003843
32095100	SOPORTE TUBO DN10 NEGR	0104	1108	<b>0,608</b>	ud	100	BOLSA	8431927003850
32095200	SOPORTE TUBO DN12 NEGR	0104	1108	<b>0,649</b>	ud	50	BOLSA	8431927003867
32095400	SOPORTE TUBO DN17 NEGR	0104	1108	<b>0,773</b>	ud	50	BOLSA	8431927003874
32095500	SOPORTE TUBO DN23 NEGR	0104	1108	<b>1,607</b>	ud	50	BOLSA	8431927003881
32095600	SOPORTE TUBO DN29 NEGR	0104	1108	<b>2,060</b>	ud	30	BOLSA	8431927003898
32095700	SOPORTE TUBO DN36 NEGR	0104	1108	<b>2,750</b>	ud	20	BOLSA	8431927003904
32095800	SOPORTE TUBO DN48 NEGR	0104	1108	<b>3,636</b>	ud	20	BOLSA	8431927003911

## TAPA SOPORTE GRIS



Ref.	Descripción	SERIE	GTV	€/ud	Unidad Venta	Unidad Embala.	Embalaje	Código EAN
31096000	TAPA SOPORTE DN 7 GRIS	0104	1108	<b>0,371</b>	ud	100	BOLSA	8431927019127
31096200	TAPA SOPORTE DN10/12 GRIS	0104	1108	<b>0,422</b>	ud	50	BOLSA	8431927002952
31096400	TAPA SOPORTE DN17 GRIS	0104	1108	<b>0,443</b>	ud	50	BOLSA	8431927002969
31096500	TAPA SOPORTE DN23 GRIS	0104	1108	<b>0,567</b>	ud	50	BOLSA	8431927002976
31096600	TAPA SOPORTE DN29 GRIS	0104	1108	<b>0,783</b>	ud	30	BOLSA	8431927002983
31096700	TAPA SOPORTE DN36 GRIS	0104	1108	<b>0,886</b>	ud	20	BOLSA	8431927002990
31096800	TAPA SOPORTE DN48 GRIS	0104	1108	<b>1,061</b>	ud	20	BOLSA	8431927003003

## TAPA SOPORTE NEGRO



Ref.	Descripción	SERIE	GTV	€/ud	Unidad Venta	Unidad Embala.	Embalaje	Código EAN
32096000	TAPA SOPORTE DN 7 NEGR	0104	1108	<b>0,371</b>	ud	100	BOLSA	8431927019134
32096200	TAPA SOPORTE DN12 NEGR	0104	1108	<b>0,422</b>	ud	50	BOLSA	8431927003928
32096400	TAPA SOPORTE DN17 NEGR	0104	1108	<b>0,443</b>	ud	50	BOLSA	8431927003935
32096500	TAPA SOPORTE DN23 NEGR	0104	1108	<b>0,567</b>	ud	50	BOLSA	8431927003942
32096600	TAPA SOPORTE DN29 NEGR	0104	1108	<b>0,783</b>	ud	30	BOLSA	8431927003959
32096700	TAPA SOPORTE DN36 NEGR	0104	1108	<b>0,886</b>	ud	20	BOLSA	8431927003966
32096800	TAPA SOPORTE DN48 NEGR	0104	1108	<b>1,061</b>	ud	20	BOLSA	8431927003973

## CLIP RAIL



Ref.	Descripción	SERIE	GTV	€/ud	Unidad Venta	Unidad Embala.	Embalaje	Código EAN
31097000	CLIP RAIL GRIS	0104	1108	<b>0,711</b>	ud	50	BOLSA	8431927003010
32097000	CLIP RAIL NEGR	0104	1108	<b>0,124</b>	ud	50	BOLSA	8431927003980

## CLIP UNIÓN



Ref.	Descripción	SERIE	GTV	€/ud	Unidad Venta	Unidad Embala.	Embalaje	Código EAN
31097500	CLIP UNION GRIS		1108		ud	100	BOLSA	8431927003027
32097500	CLIP UNION NEGR		1108		ud	100	BOLSA	8431927003997

# RACORES RECTOS PEMSAFLEX

## RACOR REP MÉTRICA GRIS IP67



Ref.	Descripción	SERIE	GTV	€/ud	Unidad Venta	Unidad Embala.	Embalaje	Código EAN
31012012	RACOR REP M12 (DN 7) GRIS	0104	1108	1,520	ud	50	BOLSA	8431927022646
31012016	RACOR REP M16 (DN 7) GRIS	0104	1108	1,558	ud	50	BOLSA	8431927022653
31012020	RACOR REP M20 (DN 7) GRIS	0104	1108	1,558	ud	50	BOLSA	8431927022660
31012112	RACOR REP M12 (DN10) GRIS	0104	1108	1,520	ud	50	BOLSA	8431927002150
31012116	RACOR REP M16 (DN10) GRIS	0104	1108	1,507	ud	50	BOLSA	8431927002167
31012120	RACOR REP M20 (DN10) GRIS	0104	1108	1,507	ud	50	BOLSA	8431927022677
31012216	RACOR REP M16 (DN12) GRIS	0104	1108	1,549	ud	50	BOLSA	8431927002174
31012220	RACOR REP M20 (DN12) GRIS	0104	1108	1,541	ud	50	BOLSA	8431927022684
31012420	RACOR REP M20 (DN17) GRIS	0104	1108	1,752	ud	50	BOLSA	8431927002181
31012425	RACOR REP M25 (DN17) GRIS	0104	1108	1,716	ud	50	BOLSA	8431927022691
31012432	RACOR REP M32 (DN17) GRIS	0104	1108	1,716	ud	50	BOLSA	8431927022707
31012525	RACOR REP M25 (DN23) GRIS	0104	1108	2,643	ud	30	BOLSA	8431927002198
31012532	RACOR REP M32 (DN23) GRIS	0104	1108	2,775	ud	30	BOLSA	8431927022714
31012632	RACOR REP M32 (DN29) GRIS	0104	1108	3,575	ud	30	BOLSA	8431927002204
31012640	RACOR REP M40 (DN29) GRIS	0104	1108	3,825	ud	30	BOLSA	8431927022721
31012740	RACOR REP M40 (DN36) GRIS	0104	1108	5,758	ud	10	BOLSA	8431927002211
31012750	RACOR REP M50 (DN36) GRIS	0104	1108	5,758	ud	10	BOLSA	8431927022738
31012850	RACOR REP M50 (DN48) GRIS	0104	1108	7,375	ud	10	BOLSA	8431927002228
31012863	RACOR REP M63 (DN48) GRIS	0104	1108	7,375	ud	10	BOLSA	8431927022745

## RACOR REP MÉTRICA NEGRO IP67 (BAJO PEDIDO)



Ref.	Descripción	SERIE	GTV	€/ud	Unidad Venta	Unidad Embala.	Embalaje	Código EAN
32012012	RACOR REP M12 (DN 7) NEGR	0104	1108	1,520	ud	50	BOLSA	8431927022752
32012016	RACOR REP M16 (DN 7) NEGR	0104	1108	1,558	ud	50	BOLSA	8431927022769
32012020	RACOR REP M20 (DN 7) NEGR	0104	1108	1,558	ud	50	BOLSA	8431927022776
32012112	RACOR REP M12 (DN10) NEGR	0104	1108	1,520	ud	50	BOLSA	8431927003218
32012116	RACOR REP M16 (DN10) NEGR	0104	1108	1,507	ud	50	BOLSA	8431927003225
32012120	RACOR REP M20 (DN10) NEGR	0104	1108	1,507	ud	50	BOLSA	8431927022783
32012216	RACOR REP M16 (DN12) NEGR	0104	1108	1,549	ud	50	BOLSA	8431927003232
32012220	RACOR REP M20 (DN12) NEGR	0104	1108	1,541	ud	50	BOLSA	8431927022790
32012420	RACOR REP M20 (DN17) NEGR	0104	1108	1,752	ud	50	BOLSA	8431927003249
32012425	RACOR REP M25 (DN17) NEGR	0104	1108	1,716	ud	50	BOLSA	8431927022806
32012432	RACOR REP M32 (DN17) NEGR	0104	1108	1,716	ud	50	BOLSA	8431927022813
32012525	RACOR REP M25 (DN23) NEGR	0104	1108	2,643	ud	30	BOLSA	8431927003256
32012532	RACOR REP M32 (DN23) NEGR	0104	1108	2,775	ud	30	BOLSA	8431927022820
32012632	RACOR REP M32 (DN29) NEGR	0104	1108	3,575	ud	30	BOLSA	8431927003263
32012640	RACOR REP M40 (DN29) NEGR	0104	1108	3,825	ud	30	BOLSA	8431927022837
32012740	RACOR REP M40 (DN36) NEGR	0104	1108	5,758	ud	10	BOLSA	8431927003270
32012750	RACOR REP M50 (DN36) NEGR	0104	1108	5,758	ud	10	BOLSA	8431927022844
32012850	RACOR REP M50 (DN48) NEGR	0104	1108	7,375	ud	10	BOLSA	8431927003287
32012863	RACOR REP M63 (DN48) NEGR	0104	1108	7,375	ud	10	BOLSA	8431927022851

## RACOR REP PG GRIS



Ref.	Descripción	SERIE	GTV	€/ud	Unidad Venta	Unidad Embala.	Embalaje	Código EAN
31010007	RACOR REP PG 7 (DN 7) GRIS	0104	1108	1,512	ud	50	BOLSA	8431927001979
31010009	RACOR REP PG 9 (DN 7) GRIS	0104	1108	1,584	ud	50	BOLSA	8431927001986
31010011	RACOR REP PG11 (DN 7) GRIS	0104	1108	1,597	ud	50	BOLSA	8431927001993
31010013	RACOR REP PG13 (DN 7) GRIS	0104	1108	1,597	ud	50	BOLSA	8431927002006
31010107	RACOR REP PG 7 (DN10) GRIS	0104	1108	1,588	ud	50	BOLSA	8431927002013
31010109	RACOR REP PG 9 (DN10) GRIS	0104	1108	1,507	ud	50	BOLSA	8431927002020
31010111	RACOR REP PG11 (DN10) GRIS	0104	1108	1,507	ud	50	BOLSA	8431927002037
31010113	RACOR REP PG13 (DN10) GRIS	0104	1108	1,507	ud	50	BOLSA	8431927002044
31010209	RACOR REP PG 9 (DN12) GRIS	0104	1108	1,740	ud	50	BOLSA	8431927002051
31010211	RACOR REP PG11 (DN12) GRIS	0104	1108	1,674	ud	50	BOLSA	8431927002068
31010213	RACOR REP PG13 (DN12) GRIS	0104	1108	1,674	ud	50	BOLSA	8431927002075
36010013	RACOR PA PG13 (DN14)	0104	1108	2,030	ud	50	BOLSA	8431927004666
31010411	RACOR REP PG11 (DN17) GRIS	0104	1108	1,674	ud	50	BOLSA	8431927022868
31010413	RACOR REP PG13 (DN17) GRIS	0104	1108	1,796	ud	50	BOLSA	8431927002082
31010416	RACOR REP PG16 (DN17) GRIS	0104	1108	1,796	ud	50	BOLSA	8431927002099
31010421	RACOR REP PG21 (DN17) GRIS	0104	1108	1,813	ud	50	BOLSA	8431927022875
31010516	RACOR REP PG16 (DN23) GRIS	0104	1108	2,565	ud	30	BOLSA	8431927002105
31010521	RACOR REP PG21 (DN23) GRIS	0104	1108	2,565	ud	30	BOLSA	8431927002112
31010629	RACOR REP PG29 (DN29) GRIS	0104	1108	3,411	ud	30	BOLSA	8431927002129
31010729	RACOR REP PG29 (DN36) GRIS	0104	1108	5,925	ud	10	BOLSA	8431927022882
31010736	RACOR REP PG36 (DN36) GRIS	0104	1108	5,758	ud	10	BOLSA	8431927002136
31010848	RACOR REP PG48 (DN48) GRIS	0104	1108	7,375	ud	10	BOLSA	8431927002143

**RACOR REP PG NEGRO IP67 (BAJO PEDIDO)**

Ref.	Descripción	SERIE	GTV	€/ud	Unidad Venta	Unidad Embala.	Embalaje	Código EAN
32010007	RACOR REP PG 7 (DN 7) NEGR	0104	1108	<b>1,512</b>	ud	50	BOLSA	8431927003034
32010009	RACOR REP PG 9 (DN 7) NEGR	0104	1108	<b>1,584</b>	ud	50	BOLSA	8431927003041
32010011	RACOR REP PG11 (DN 7) NEGR	0104	1108	<b>1,597</b>	ud	50	BOLSA	8431927003058
32010013	RACOR REP PG13 (DN 7) NEGR	0104	1108	<b>1,597</b>	ud	50	BOLSA	8431927003065
32010107	RACOR REP PG 7 (DN10) NEGR	0104	1108	<b>1,754</b>	ud	50	BOLSA	8431927003072
32010109	RACOR REP PG 9 (DN10) NEGR	0104	1108	<b>1,507</b>	ud	50	BOLSA	8431927003089
32010111	RACOR REP PG11 (DN10) NEGR	0104	1108	<b>1,507</b>	ud	50	BOLSA	8431927003096
32010113	RACOR REP PG13 (DN10) NEGR	0104	1108	<b>1,507</b>	ud	50	BOLSA	8431927003102
32010209	RACOR REP PG 9 (DN12) NEGR	0104	1108	<b>1,740</b>	ud	50	BOLSA	8431927003119
32010211	RACOR REP PG11 (DN12) NEGR	0104	1108	<b>1,674</b>	ud	50	BOLSA	8431927003126
32010213	RACOR REP PG13 (DN12) NEGR	0104	1108	<b>1,674</b>	ud	50	BOLSA	8431927003133
32010411	RACOR REP PG11 (DN17) NEGR	0104	1108	<b>1,674</b>	ud	50	BOLSA	8431927022899
32010413	RACOR REP PG13 (DN17) NEGR	0104	1108	<b>1,796</b>	ud	50	BOLSA	8431927003140
32010416	RACOR REP PG16 (DN17) NEGR	0104	1108	<b>1,796</b>	ud	50	BOLSA	8431927003157
32010421	RACOR REP PG21 (DN17) NEGR	0104	1108	<b>1,813</b>	ud	50	BOLSA	8431927022905
32010516	RACOR REP PG16 (DN23) NEGR	0104	1108	<b>2,565</b>	ud	30	BOLSA	8431927003164
32010521	RACOR REP PG21 (DN23) NEGR	0104	1108	<b>2,565</b>	ud	30	BOLSA	8431927003171
32010629	RACOR REP PG29 (DN29) NEGR	0104	1108	<b>3,411</b>	ud	30	BOLSA	8431927003188
32010729	RACOR REP PG29 (DN36) NEGR	0104	1108	<b>5,925</b>	ud	10	BOLSA	8431927022912
32010736	RACOR REP PG36 (DN36) NEGR	0104	1108	<b>5,758</b>	ud	10	BOLSA	8431927003195
32010848	RACOR REP PG48 (DN48) NEGR	0104	1108	<b>7,375</b>	ud	10	BOLSA	8431927003201

**RACOR REM Métrica GRIS IP67**

Ref.	Descripción	SERIE	GTV	€/ud	Unidad Venta	Unidad Embala.	Embalaje	Código EAN
31013116	RACOR REM M16 (DN10) GRIS	0104	1108	<b>5,630</b>	ud	30	BOLSA	8431927022929
31013120	RACOR REM M20 (DN10) GRIS	0104	1108	<b>5,709</b>	ud	30	BOLSA	8431927022936
31013216	RACOR REM M16 (DN12) GRIS	0104	1108	<b>6,355</b>	ud	30	BOLSA	8431927022943
31013220	RACOR REM M20 (DN12) GRIS	0104	1108	<b>6,860</b>	ud	30	BOLSA	8431927022950
31013420	RACOR REM M20 (DN17) GRIS	0104	1108	<b>8,353</b>	ud	30	BOLSA	8431927022967
31013425	RACOR REM M25 (DN17) GRIS	0104	1108	<b>8,353</b>	ud	30	BOLSA	8431927022974
31013525	RACOR REM M25 (DN23) GRIS	0104	1108	<b>14,348</b>	ud	30	BOLSA	8431927022981
31013532	RACOR REM M32 (DN23) GRIS	0104	1108	<b>13,256</b>	ud	30	BOLSA	8431927022998
31013632	RACOR REM M32 (DN29) GRIS	0104	1108	<b>17,253</b>	ud	20	BOLSA	8431927023001
31013640	RACOR REM M40 (DN29) GRIS	0104	1108	<b>18,190</b>	ud	20	BOLSA	8431927023018
31013750	RACOR REM M50 (DN36) GRIS	0104	1108	<b>33,413</b>	ud	10	BOLSA	8431927023025
31013863	RACOR REM M63 (DN48) GRIS	0104	1108	<b>36,380</b>	ud	10	BOLSA	8431927023032

**RACOR REM Métrica NEGRO IP67 (BAJO PEDIDO)**

Ref.	Descripción	SERIE	GTV	€/ud	Unidad Venta	Unidad Embala.	Embalaje	Código EAN
32013116	RACOR REM M16 (DN10) NEGR	0104	1108	<b>5,630</b>	ud	30	BOLSA	8431927023049
32013120	RACOR REM M20 (DN10) NEGR	0104	1108	<b>5,709</b>	ud	30	BOLSA	8431927023056
32013216	RACOR REM M16 (DN12) NEGR	0104	1108	<b>6,355</b>	ud	30	BOLSA	8431927023063
32013220	RACOR REM M20 (DN12) NEGR	0104	1108	<b>6,860</b>	ud	30	BOLSA	8431927023070
32013420	RACOR REM M20 (DN17) NEGR	0104	1108	<b>8,353</b>	ud	30	BOLSA	8431927023087
32013425	RACOR REM M25 (DN17) NEGR	0104	1108	<b>8,353</b>	ud	30	BOLSA	8431927023094
32013525	RACOR REM M25 (DN23) NEGR	0104	1108	<b>14,348</b>	ud	30	BOLSA	8431927023100
32013532	RACOR REM M32 (DN23) NEGR	0104	1108	<b>13,256</b>	ud	30	BOLSA	8431927023117
32013632	RACOR REM M32 (DN29) NEGR	0104	1108	<b>17,253</b>	ud	20	BOLSA	8431927023124
32013640	RACOR REM M40 (DN29) NEGR	0104	1108	<b>18,190</b>	ud	20	BOLSA	8431927023131
32013750	RACOR REM M50 (DN36) NEGR	0104	1108	<b>33,413</b>	ud	10	BOLSA	8431927023148
32013863	RACOR REM M63 (DN48) NEGR	0104	1108	<b>36,380</b>	ud	10	BOLSA	8431927023155

**RACOR RREP Métrica GRIS IP67**

Ref.	Descripción	SERIE	GTV	€/ud	Unidad Venta	Unidad Embala.	Embalaje	Código EAN
31101112	RACOR RREP M12 (DN10) GRIS	0104	1108	<b>2,493</b>	ud	50	BOLSA	8431927023162
31101116	RACOR RREP M16 (DN10) GRIS	0104	1108	<b>2,493</b>	ud	50	BOLSA	8431927023179
31101120	RACOR RREP M20 (DN10) GRIS	0104	1108	<b>2,493</b>	ud	50	BOLSA	8431927023186
31101216	RACOR RREP M16 (DN12) GRIS	0104	1108	<b>2,513</b>	ud	50	BOLSA	8431927023193
31101220	RACOR RREP M20 (DN12) GRIS	0104	1108	<b>2,513</b>	ud	50	BOLSA	8431927023209
31101420	RACOR RREP M20 (DN17) GRIS	0104	1108	<b>2,534</b>	ud	50	BOLSA	8431927023216
31101425	RACOR RREP M25 (DN17) GRIS	0104	1108	<b>2,534</b>	ud	50	BOLSA	8431927023223
31101525	RACOR RREP M25 (DN23) GRIS	0104	1108	<b>4,182</b>	ud	30	BOLSA	8431927023230
31101532	RACOR RREP M32 (DN23) GRIS	0104	1108	<b>4,295</b>	ud	30	BOLSA	8431927023247
31101632	RACOR RREP M32 (DN29) GRIS	0104	1108	<b>5,438</b>	ud	30	BOLSA	8431927023254
31101640	RACOR RREP M40 (DN29) GRIS	0104	1108	<b>5,438</b>	ud	30	BOLSA	8431927023261
31101740	RACOR RREP M40 (DN36) GRIS	0104	1108	<b>9,260</b>	ud	10	BOLSA	8431927023278
31101750	RACOR RREP M50 (DN36) GRIS	0104	1108	<b>9,260</b>	ud	10	BOLSA	8431927023285
31101850	RACOR RREP M50 (DN48) GRIS	0104	1108	<b>12,690</b>	ud	10	BOLSA	8431927023292
31101863	RACOR RREP M63 (DN48) GRIS	0104	1108	<b>12,968</b>	ud	10	BOLSA	8431927023308

**RACOR RREP Métrica NEGRO IP67 (BAJO PEDIDO)**

Ref.	Descripción	SERIE	GTV	€/ud	Unidad Venta	Unidad Embala.	Embalaje	Código EAN
32101112	RACOR RREP M12 (DN10) NEGR	0104	1108	<b>2,493</b>	ud	50	BOLSA	8431927023315
32101116	RACOR RREP M16 (DN10) NEGR	0104	1108	<b>2,493</b>	ud	50	BOLSA	8431927023322
32101120	RACOR RREP M20 (DN10) NEGR	0104	1108	<b>2,493</b>	ud	50	BOLSA	8431927023339
32101216	RACOR RREP M16 (DN12) NEGR	0104	1108	<b>2,513</b>	ud	50	BOLSA	8431927023346
32101220	RACOR RREP M20 (DN12) NEGR	0104	1108	<b>2,513</b>	ud	50	BOLSA	8431927023353
32101420	RACOR RREP M20 (DN17) NEGR	0104	1108	<b>2,534</b>	ud	50	BOLSA	8431927023360
32101425	RACOR RREP M25 (DN17) NEGR	0104	1108	<b>2,534</b>	ud	50	BOLSA	8431927023377
32101525	RACOR RREP M25 (DN23) NEGR	0104	1108	<b>4,182</b>	ud	30	BOLSA	8431927023391
32101532	RACOR RREP M32 (DN23) NEGR	0104	1108	<b>4,295</b>	ud	30	BOLSA	8431927023407
32101632	RACOR RREP M32 (DN29) NEGR	0104	1108	<b>5,438</b>	ud	30	BOLSA	8431927023414
32101640	RACOR RREP M40 (DN29) NEGR	0104	1108	<b>5,438</b>	ud	30	BOLSA	8431927023421
32101740	RACOR RREP M40 (DN36) NEGR	0104	1108	<b>9,260</b>	ud	10	BOLSA	8431927023438
32101750	RACOR RREP M50 (DN36) NEGR	0104	1108	<b>9,260</b>	ud	10	BOLSA	8431927023445
32101850	RACOR RREP M50 (DN48) NEGR	0104	1108	<b>12,690</b>	ud	10	BOLSA	8431927023452
32101863	RACOR RREP M63 (DN48) NEGR	0104	1108	<b>12,968</b>	ud	10	BOLSA	8431927024268

**RACOR RREP PG GRIS IP67**

Ref.	Descripción	SERIE	GTV	€/ud	Unidad Venta	Unidad Embala.	Embalaje	Código EAN
31100107	RACOR RREP PG 7 (DN10) GRIS	0104	1108	<b>2,307</b>	ud	50	BOLSA	8431927023469
31100109	RACOR RREP PG 9 (DN10) GRIS	0104	1108	<b>2,307</b>	ud	50	BOLSA	8431927023476
31100111	RACOR RREP PG11 (DN10) GRIS	0104	1108	<b>2,307</b>	ud	50	BOLSA	8431927023483
31100113	RACOR RREP PG13 (DN10) GRIS	0104	1108	<b>2,307</b>	ud	50	BOLSA	8431927023490
31100209	RACOR RREP PG 9 (DN12) GRIS	0104	1108	<b>2,328</b>	ud	50	BOLSA	8431927023506
31100211	RACOR RREP PG11 (DN12) GRIS	0104	1108	<b>2,328</b>	ud	50	BOLSA	8431927023513
31100213	RACOR RREP PG13 (DN12) GRIS	0104	1108	<b>2,328</b>	ud	50	BOLSA	8431927023520
31100411	RACOR RREP PG11 (DN17) GRIS	0104	1108	<b>2,348</b>	ud	50	BOLSA	8431927023537
31100413	RACOR RREP PG13 (DN17) GRIS	0104	1108	<b>2,348</b>	ud	50	BOLSA	8431927023544
31100416	RACOR RREP PG16 (DN17) GRIS	0104	1108	<b>2,348</b>	ud	50	BOLSA	8431927023551
31100421	RACOR RREP PG21 (DN17) GRIS	0104	1108	<b>3,080</b>	ud	50	BOLSA	8431927023568
31100516	RACOR RREP PG16 (DN23) GRIS	0104	1108	<b>3,873</b>	ud	30	BOLSA	8431927023575
31100521	RACOR RREP PG21 (DN23) GRIS	0104	1108	<b>3,873</b>	ud	30	BOLSA	8431927023582
31100629	RACOR RREP PG29 (DN29) GRIS	0104	1108	<b>5,026</b>	ud	30	BOLSA	8431927023599
31100729	RACOR RREP PG29 (DN36) GRIS	0104	1108	<b>8,570</b>	ud	10	BOLSA	8431927023605
31100736	RACOR RREP PG36 (DN36) GRIS	0104	1108	<b>8,570</b>	ud	10	BOLSA	8431927023612
31100848	RACOR RREP PG48 (DN48) GRIS	0104	1108	<b>11,073</b>	ud	10	BOLSA	8431927023629

**RACOR RREP PG NEGRO IP67 (BAJO PEDIDO)**

Ref.	Descripción	SERIE	GTV	€/ud	Unidad Venta	Unidad Embala.	Embalaje	Código EAN
32100107	RACOR RREP PG 7 (DN10) NEGR	0104	1108	<b>2,307</b>	ud	50	BOLSA	8431927023636
32100109	RACOR RREP PG 9 (DN10) NEGR	0104	1108	<b>2,307</b>	ud	50	BOLSA	8431927023643
32100111	RACOR RREP PG11 (DN10) NEGR	0104	1108	<b>2,307</b>	ud	50	BOLSA	8431927023650
32100113	RACOR RREP PG13 (DN10) NEGR	0104	1108	<b>2,307</b>	ud	50	BOLSA	8431927023667
32100209	RACOR RREP PG 9 (DN12) NEGR	0104	1108	<b>2,328</b>	ud	50	BOLSA	8431927023674
32100211	RACOR RREP PG11 (DN12) NEGR	0104	1108	<b>2,328</b>	ud	50	BOLSA	8431927023681
32100213	RACOR RREP PG13 (DN12) NEGR	0104	1108	<b>2,328</b>	ud	50	BOLSA	8431927023698
32100411	RACOR RREP PG11 (DN17) NEGR	0104	1108	<b>2,348</b>	ud	50	BOLSA	8431927023704
32100413	RACOR RREP PG13 (DN17) NEGR	0104	1108	<b>2,348</b>	ud	50	BOLSA	8431927023711
32100416	RACOR RREP PG16 (DN17) NEGR	0104	1108	<b>2,348</b>	ud	50	BOLSA	8431927023728
32100421	RACOR RREP PG21 (DN17) NEGR	0104	1108	<b>3,080</b>	ud	50	BOLSA	8431927023735
32100516	RACOR RREP PG16 (DN23) NEGR	0104	1108	<b>3,873</b>	ud	30	BOLSA	8431927023742
32100521	RACOR RREP PG21 (DN23) NEGR	0104	1108	<b>3,873</b>	ud	30	BOLSA	8431927023759
32100629	RACOR RREP PG29 (DN29) NEGR	0104	1108	<b>5,026</b>	ud	30	BOLSA	8431927023766
32100729	RACOR RREP PG29 (DN29) NEGR	0104	1108	<b>8,570</b>	ud	10	BOLSA	8431927023773
32100736	RACOR RREP PG36 (DN36) NEGR	0104	1108	<b>8,570</b>	ud	10	BOLSA	8431927023780
32100848	RACOR RREP PG48 (DN48) NEGR	0104	1108	<b>11,073</b>	ud	10	BOLSA	8431927023797

**RACOR RRIP MÉTRICA GRIS IP67**

Ref.	Descripción	SERIE	GTV	€/ud	Unidad Venta	Unidad Embala.	Embalaje	Código EAN
31111116	RACOR RRIP M16 (DN10) GRIS	0104	1108	<b>3,584</b>	ud	50	BOLSA	8431927023803
31111216	RACOR RRIP M16 (DN12) GRIS	0104	1108	<b>3,646</b>	ud	50	BOLSA	8431927023810
31111420	RACOR RRIP M20 (DN17) GRIS	0104	1108	<b>3,780</b>	ud	50	BOLSA	8431927023827
31111525	RACOR RRIP M25 (DN23) GRIS	0104	1108	<b>7,715</b>	ud	30	BOLSA	8431927023834
31111632	RACOR RRIP M32 (DN29) GRIS	0104	1108	<b>13,297</b>	ud	30	BOLSA	8431927023841
31111740	RACOR RRIP M40 (DN36) GRIS	0104	1108	<b>14,554</b>	ud	10	BOLSA	8431927023858
31111863	RACOR RRIP M50 (DN48) GRIS	0104	1108	<b>26,317</b>	ud	10	BOLSA	8431927023865

**RACOR RRIP MÉTRICA NEGRO IP67 (BAJO PEDIDO)**

Ref.	Descripción	SERIE	GTV	€/ud	Unidad Venta	Unidad Embala.	Embalaje	Código EAN
32111116	RACOR RRIP M16 (DN10) NEGR	0104	1108	<b>3,584</b>	ud	50	BOLSA	8431927023889
32111216	RACOR RRIP M16 (DN12) NEGR	0104	1108	<b>3,646</b>	ud	50	BOLSA	8431927023889
32111420	RACOR RRIP M20 (DN17) NEGR	0104	1108	<b>3,780</b>	ud	50	BOLSA	8431927023896
32111525	RACOR RRIP M25 (DN23) NEGR	0104	1108	<b>7,715</b>	ud	30	BOLSA	8431927023902
32111632	RACOR RRIP M32 (DN29) NEGR	0104	1108	<b>13,297</b>	ud	30	BOLSA	8431927023919
32111740	RACOR RRIP M40 (DN36) NEGR	0104	1108	<b>14,554</b>	ud	10	BOLSA	8431927023926
32111850	RACOR RRIP M50 (DN48) NEGR	0104	1108	<b>26,317</b>	ud	10	BOLSA	8431927023933

**RACOR RRIP PG GRIS IP67**

Ref.	Descripción	SERIE	GTV	€/ud	Unidad Venta	Unidad Embala.	Embalaje	Código EAN
31110107	RACOR RRIP PG 7 (DN10) GRIS	0104	1108	<b>3,584</b>	ud	50	BOLSA	8431927023940
31110109	RACOR RRIP PG 9 (DN10) GRIS	0104	1108	<b>3,584</b>	ud	50	BOLSA	8431927023957
31110211	RACOR RRIP PG11 (DN12) GRIS	0104	1108	<b>3,646</b>	ud	50	BOLSA	8431927023964
31110213	RACOR RRIP PG13 (DN12) GRIS	0104	1108	<b>3,646</b>	ud	50	BOLSA	8431927023971
31110413	RACOR RRIP PG13 (DN17) GRIS	0104	1108	<b>3,780</b>	ud	50	BOLSA	8431927023988
31110416	RACOR RRIP PG16 (DN17) GRIS	0104	1108	<b>3,780</b>	ud	50	BOLSA	8431927023995
31110521	RACOR RRIP PG21 (DN23) GRIS	0104	1108	<b>7,746</b>	ud	30	BOLSA	8431927024008
31110629	RACOR RRIP PG29 (DN29) GRIS	0104	1108	<b>13,297</b>	ud	30	BOLSA	8431927024015
31110736	RACOR RRIP PG36 (DN36) GRIS	0104	1108	<b>14,554</b>	ud	10	BOLSA	8431927024022
31110848	RACOR RRIP PG48 (DN48) GRIS	0104	1108	<b>26,317</b>	ud	10	BOLSA	8431927024039

**RACOR RRIP PG NEGRO IP67 (BAJO PEDIDO)**

Ref.	Descripción	SERIE	GTV	€/ud	Unidad Venta	Unidad Embala.	Embalaje	Código EAN
32110107	RACOR RRIP PG 7 (DN10) NEGR	0104	1108	<b>3,584</b>	ud	50	BOLSA	8431927024053
32110109	RACOR RRIP PG 9 (DN10) NEGR	0104	1108	<b>3,584</b>	ud	50	BOLSA	8431927024060
32110211	RACOR RRIP PG11 (DN12) NEGR	0104	1108	<b>3,646</b>	ud	50	BOLSA	8431927024077
32110213	RACOR RRIP PG13 (DN12) NEGR	0104	1108	<b>3,646</b>	ud	50	BOLSA	8431927024084
32110413	RACOR RRIP PG13 (DN17) NEGR	0104	1108	<b>3,780</b>	ud	50	BOLSA	8431927024091
32110416	RACOR RRIP PG16 (DN17) NEGR	0104	1108	<b>3,780</b>	ud	50	BOLSA	8431927024107
32110521	RACOR RRIP PG21 (DN23) NEGR	0104	1108	<b>7,746</b>	ud	30	BOLSA	8431927024114
32110629	RACOR RRIP PG29 (DN29) NEGR	0104	1108	<b>13,297</b>	ud	30	BOLSA	8431927024121
32110736	RACOR RRIP PG36 (DN36) NEGR	0104	1108	<b>14,554</b>	ud	10	BOLSA	8431927024138
32110848	RACOR RRIP PG48 (DN48) NEGR	0104	1108	<b>26,317</b>	ud	10	BOLSA	8431927023872

**RACOR RREM Métrica GRIS IP67**

Ref.	Descripción	SERIE	GTV	€/ud	Unidad Venta	Unidad Embala.	Embalaje	Código EAN
31102116	RACOR RREM M16 (DN10) GRIS	0104	1108	<b>6,345</b>	ud	30	BOLSA	8431927024145
31102120	RACOR RREM M20 (DN10) GRIS	0104	1108	<b>6,345</b>	ud	30	BOLSA	8431927024152
31102216	RACOR RREM M16 (DN12) GRIS	0104	1108	<b>7,406</b>	ud	30	BOLSA	8431927024169
31102220	RACOR RREM M20 (DN12) GRIS	0104	1108	<b>7,406</b>	ud	30	BOLSA	8431927024176
31102420	RACOR RREM M20 (DN17) GRIS	0104	1108	<b>8,879</b>	ud	30	BOLSA	8431927024183
31102425	RACOR RREM M25 (DN17) GRIS	0104	1108	<b>8,879</b>	ud	30	BOLSA	8431927024190
31102525	RACOR RREM M25 (DN23) GRIS	0104	1108	<b>15,872</b>	ud	30	BOLSA	8431927024206
31102532	RACOR RREM M32 (DN23) GRIS	0104	1108	<b>15,872</b>	ud	30	BOLSA	8431927024213
31102632	RACOR RREM M32 (DN29) GRIS	0104	1108	<b>18,046</b>	ud	20	BOLSA	8431927024220
31102640	RACOR RREM M40 (DN29) GRIS	0104	1108	<b>18,046</b>	ud	20	BOLSA	8431927024237
31102750	RACOR RREM M50 (DN36) GRIS	0104	1108	<b>28,861</b>	ud	10	BOLSA	8431927024244
31102848	RACOR RREM M63 (DN48) GRIS	0104	1108	<b>38,059</b>	ud	10	BOLSA	8431927024251

**RACOR RREM Métrica NEGRO IP67 (BAJO PEDIDO)**

Ref.	Descripción	SERIE	GTV	€/ud	Unidad Venta	Unidad Embala.	Embalaje	Código EAN
32102116	RACOR RREM M16 (DN10) NEGR	0104	1108	<b>6,345</b>	ud	30	BOLSA	8431927024275
32102120	RACOR RREM M20 (DN10) NEGR	0104	1108	<b>6,345</b>	ud	30	BOLSA	8431927024282
32102216	RACOR RREM M16 (DN12) NEGR	0104	1108	<b>7,406</b>	ud	30	BOLSA	8431927024299
32102220	RACOR RREM M20 (DN12) NEGR	0104	1108	<b>7,406</b>	ud	30	BOLSA	8431927024305
32102420	RACOR RREM M20 (DN17) NEGR	0104	1108	<b>8,879</b>	ud	30	BOLSA	8431927024312
32102425	RACOR RREM M25 (DN17) NEGR	0104	1108	<b>8,879</b>	ud	30	BOLSA	8431927024329
32102525	RACOR RREM M25 (DN23) NEGR	0104	1108	<b>15,872</b>	ud	30	BOLSA	8431927024336
32102532	RACOR RREM M32 (DN23) NEGR	0104	1108	<b>15,872</b>	ud	30	BOLSA	8431927024343
32102632	RACOR RREM M32 (DN29) NEGR	0104	1108	<b>18,046</b>	ud	20	BOLSA	8431927024350
32102640	RACOR RREM M40 (DN29) NEGR	0104	1108	<b>18,046</b>	ud	20	BOLSA	8431927024367
32102750	RACOR RREM M50 (DN36) NEGR	0104	1108	<b>28,861</b>	ud	10	BOLSA	8431927024374
32102863	RACOR RREM M63 (DN48) NEGR	0104	1108	<b>38,059</b>	ud	10	BOLSA	8431927024046

**RACOR RECTO INTERIOR PG GRIS IP65**

Ref.	Descripción	SERIE	GTV	€/ud	Unidad Venta	Unidad Embala.	Embalaje	Código EAN
31020109	RACOR RECTO INT PG 9 (DN10)	0104	1108	<b>3,481</b>	ud	50	BOLSA	8431927002235
31020211	RACOR RECTO INT PG11 (DN12)	0104	1108	<b>3,564</b>	ud	50	BOLSA	8431927002242
31020413	RACOR RECTO INT PG13 (DN17)	0104	1108	<b>3,698</b>	ud	50	BOLSA	8431927002259
31020416	RACOR RECTO INT PG16 (DN17)	0104	1108	<b>3,698</b>	ud	50	BOLSA	8431927002266
31020521	RACOR RECTO INT PG21 (DN23)	0104	1108	<b>7,797</b>	ud	30	BOLSA	8431927002273
31020629	RACOR RECTO INT PG29 (DN29)	0104	1108	<b>13,205</b>	ud	30	BOLSA	8431927002280
31020736	RACOR RECTO INT PG36 (DN36)	0104	1108	<b>13,308</b>	ud	10	BOLSA	8431927002297
31020848	RACOR RECTO INT PG48 (DN48)	0104	1108	<b>24,967</b>	ud	10	BOLSA	8431927002303

**RACOR RECTO INTERIOR NEGRO IP65 (BAJO PEDIDO)**

Ref.	Descripción	SERIE	GTV	€/ud	Unidad Venta	Unidad Embala.	Embalaje	Código EAN
32020109	RACOR RECTO INT PG 9 (DN10) NEGR	0104	1108	<b>3,481</b>	ud	50	BOLSA	8431927003294
32020211	RACOR RECTO INT PG11 (DN12) NEGR	0104	1108	<b>3,564</b>	ud	50	BOLSA	8431927003300
32020413	RACOR RECTO INT PG13 (DN17) NEGR	0104	1108	<b>3,698</b>	ud	50	BOLSA	8431927003317
32020416	RACOR RECTO INT PG16 (DN17) NEGR	0104	1108	<b>3,698</b>	ud	50	BOLSA	8431927003324
32020521	RACOR RECTO INT PG21 (DN23) NEGR	0104	1108	<b>7,797</b>	ud	30	BOLSA	8431927003331
32020629	RACOR RECTO INT PG29 (DN29) NEGR	0104	1108	<b>13,205</b>	ud	30	BOLSA	8431927003348
32020736	RACOR RECTO INT PG36 (DN36) NEGR	0104	1108	<b>13,308</b>	ud	10	BOLSA	8431927003355
32020848	RACOR RECTO INT PG48 (DN48) NEGR	0104	1108	<b>24,967</b>	ud	10	BOLSA	8431927003362

**RACOR PI IP67 GRIS**

Ref.	Descripción	SERIE	GTV	€/ud	Unidad Venta	Unidad Embala.	Embalaje	Código EAN
31140109	RACOR PI DN10 GRIS	0104	1108	<b>4,687</b>	ud	50	BOLSA	8431927025302
31140211	RACOR PI DN12 GRIS	0104	1108	<b>4,717</b>	ud	50	BOLSA	8431927025319
31140416	RACOR PI DN17 GRIS	0104	1108	<b>4,872</b>	ud	50	BOLSA	8431927025326
31140521	RACOR PI DN23 GRIS	0104	1108	<b>7,787</b>	ud	30	BOLSA	8431927025333
31140629	RACOR PI DN29 GRIS	0104	1108	<b>10,115</b>	ud	30	BOLSA	8431927025340

**RACOR PI IP67 NEGRO (BAJO PEDIDO)**

Ref.	Descripción	SERIE	GTV	€/ud	Unidad Venta	Unidad Embala.	Embalaje	Código EAN
32140109	RACOR PI DN10 NEGR	0104	1108	<b>4,687</b>	ud	50	BOLSA	8431927025357
32140211	RACOR PI DN12 NEGR	0104	1108	<b>4,717</b>	ud	50	BOLSA	8431927025364
32140416	RACOR PI DN17 NEGR	0104	1108	<b>4,872</b>	ud	50	BOLSA	8431927025371
32140521	RACOR PI DN23 NEGR	0104	1108	<b>7,787</b>	ud	30	BOLSA	8431927025388
32140629	RACOR PI DN29 NEGR	0104	1108	<b>10,115</b>	ud	30	BOLSA	8431927025395

**RACOR AD IP54 GRIS**

Ref.	Descripción	SERIE	GTV	€/ud	Unidad Venta	Unidad Embala.	Embalaje	Código EAN
39094208	RACOR AD M 8X1 (DN 7) GRIS	0104	1108	<b>5,628</b>	ud	50	BOLSA	8431927005311
39094412	RACOR AD M12X1 (DN 7) GRIS	0104	1108	<b>5,628</b>	ud	50	BOLSA	8431927005328
39094518	RACOR AD M18X1 (DN 7) GRIS	0104	1108	<b>5,628</b>	ud	50	BOLSA	8431927005335
39094608	RACOR AD M 8X1 (DN10) GRIS	0104	1108	<b>5,683</b>	ud	50	BOLSA	8431927005342
39094612	RACOR AD M12X1 (DN10) GRIS	0104	1108	<b>5,683</b>	ud	50	BOLSA	8431927005359
39094618	RACOR AD M18X1 (DN10) GRIS	0104	1108	<b>5,683</b>	ud	50	BOLSA	8431927005366
39094730	RACOR AD M30X1,5 (DN10) GRIS	0104	1108	<b>6,389</b>	ud	50	BOLSA	8431927005373

**RACOR AD IP54 NEGRO (BAJO PEDIDO)**

Ref.	Descripción	SERIE	GTV	€/ud	Unidad Venta	Unidad Embala.	Embalaje	Código EAN
39097208	RACOR AD M 8X1 (DN 7) NEGR	0104	1108	<b>5,628</b>	ud	50	BOLSA	8431927025494
39097412	RACOR AD M12X1 (DN 7) NEGR	0104	1108	<b>5,628</b>	ud	50	BOLSA	8431927025500
39097518	RACOR AD M18X1 (DN 7) NEGR	0104	1108	<b>5,628</b>	ud	50	BOLSA	8431927025517
39097608	RACOR AD M 8X1 (DN10) NEGR	0104	1108	<b>5,683</b>	ud	50	BOLSA	8431927025524
39097612	RACOR AD M12X1 (DN10) NEGR	0104	1108	<b>5,683</b>	ud	50	BOLSA	8431927025531
39097618	RACOR AD M18X1 (DN10) NEGR	0104	1108	<b>5,683</b>	ud	50	BOLSA	8431927025548
39097730	RACOR AD M30X1,5 (DN10) NEGR	0104	1108	<b>6,389</b>	ud	50	BOLSA	8431927025555

**RACOR AT IP67 GRIS**

Ref.	Descripción	SERIE	GTV	€/ud	Unidad Venta	Unidad Embala.	Embalaje	Código EAN
31151420	RACOR AT M20 (DN17) GRIS	0104	1108	<b>24,772</b>	ud	30	BOLSA	8431927025562
31151425	RACOR AT M25 (DN17) GRIS	0104	1108	<b>24,772</b>	ud	30	BOLSA	8431927025579
31151632	RACOR AT M32 (DN29) GRIS	0104	1108	<b>39,202</b>	ud	20	BOLSA	CONSULTAR
31151740	RACOR AT M40 (DN36) GRIS	0104	1108	<b>49,831</b>	ud	10	BOLSA	CONSULTAR

**RACOR AT IP67 NEGRO (BAJO PEDIDO)**

Ref.	Descripción	SERIE	GTV	€/ud	Unidad Venta	Unidad Embala.	Embalaje	Código EAN
32151420	RACOR AT M20 (DN17) NEGR	0104	1108	<b>24,772</b>	ud	30	BOLSA	8431927025586
32151425	RACOR AT M25 (DN17) NEGR	0104	1108	<b>24,772</b>	ud	30	BOLSA	8431927025593
32151632	RACOR AT M32 (DN29) NEGR	0104	1108	<b>39,202</b>	ud	20	BOLSA	CONSULTAR
32151740	RACOR AT M40 (DN36) NEGR	0104	1108	<b>49,831</b>	ud	10	BOLSA	CONSULTAR



# RACORES ANGULARES

## RACOR RA 45 PG GRIS IP67



Ref.	Descripción	SERIE	GTV	€/ud	Unidad Venta	Unidad Embala.	Embalaje	Código EAN
31030007	RACOR RA 45 PG 7 (DN 7) GRIS	0104	1108	<b>4,130</b>	ud	50	BOLSA	8431927002310
31030109	RACOR RA 45 PG 9 (DN10) GRIS	0104	1108	<b>4,130</b>	ud	50	BOLSA	8431927002327
31030211	RACOR RA 45 PG11 (DN12) GRIS	0104	1108	<b>4,223</b>	ud	50	BOLSA	8431927002334
31030416	RACOR RA 45 PG16 (DN17) GRIS	0104	1108	<b>4,450</b>	ud	50	BOLSA	8431927002341
31030521	RACOR RA 45 PG21 (DN23) GRIS	0104	1108	<b>7,344</b>	ud	30	BOLSA	8431927002358
31030629	RACOR RA 45 PG29 (DN29) GRIS	0104	1108	<b>10,681</b>	ud	30	BOLSA	8431927002365

## RACOR RA 45 PG NEGRO IP67 (BAJO PEDIDO)



Ref.	Descripción	SERIE	GTV	€/ud	Unidad Venta	Unidad Embala.	Embalaje	Código EAN
32030007	RACOR RA 45 PG 7 (DN 7) NEGR	0104	1108	<b>4,130</b>	ud	50	BOLSA	8431927003379
32030109	RACOR RA 45 PG 9 (DN10) NEGR	0104	1108	<b>4,130</b>	ud	50	BOLSA	8431927003386
32030211	RACOR RA 45 PG11 (DN12) NEGR	0104	1108	<b>4,223</b>	ud	50	BOLSA	8431927003393
32030416	RACOR RA 45 PG16 (DN17) NEGR	0104	1108	<b>4,450</b>	ud	50	BOLSA	8431927003409
32030521	RACOR RA 45 PG21 (DN23) NEGR	0104	1108	<b>7,344</b>	ud	30	BOLSA	8431927003416
32030629	RACOR RA 45 PG29 (DN29) NEGR	0104	1108	<b>10,681</b>	ud	30	BOLSA	8431927003423

## RACOR AB 90 GRIS IP67



Ref.	Descripción	SERIE	GTV	€/ud	Unidad Venta	Unidad Embala.	Embalaje	Código EAN
31050400	RACOR AB 90 DN17 GRIS	0104	1108	<b>4,389</b>	ud	30	BOLSA	8431927002532
31050500	RACOR AB 90 DN23 GRIS	0104	1108	<b>5,758</b>	ud	30	BOLSA	8431927002549
31050600	RACOR AB 90 DN29 GRIS	0104	1108	<b>8,611</b>	ud	20	BOLSA	8431927002556
31050700	RACOR AB 90 DN36 GRIS	0104	1108	<b>12,710</b>	ud	10	BOLSA	8431927002563
31050800	RACOR AB 90 DN48 GRIS	0104	1108	<b>17,325</b>	ud	10	BOLSA	8431927002570

## RACOR AB 90 NEGRO IP67



Ref.	Descripción	SERIE	GTV	€/ud	Unidad Venta	Unidad Embala.	Embalaje	Código EAN
32050400	RACOR AB 90 DN17 NEGR	0104	1108	<b>4,389</b>	ud	30	BOLSA	8431927003591
32050500	RACOR AB 90 DN23 NEGR	0104	1108	<b>5,758</b>	ud	30	BOLSA	8431927003607
32050600	RACOR AB 90 DN29 NEGR	0104	1108	<b>8,611</b>	ud	20	BOLSA	8431927003614
32050700	RACOR AB 90 DN36 NEGR	0104	1108	<b>12,710</b>	ud	10	BOLSA	8431927003621
32050800	RACOR AB 90 DN48 NEGR	0104	1108	<b>17,325</b>	ud	10	BOLSA	8431927003638

## RACOR RA 90 Métrica GRIS IP67



Ref.	Descripción	SERIE	GTV	€/ud	Unidad Venta	Unidad Embala.	Embalaje	Código EAN
31042012	RACOR RA 90 M12 (DN 7) GRIS	0104	1108	<b>3,090</b>	ud	50	BOLSA	8431927024381
31042016	RACOR RA 90 M16 (DN 7) GRIS	0104	1108	<b>3,193</b>	ud	50	BOLSA	8431927024398
31042020	RACOR RA 90 M20 (DN 7) GRIS	0104	1108	<b>3,193</b>	ud	50	BOLSA	8431927024404
31042116	RACOR RA 90 M16 (DN10) GRIS	0104	1108	<b>4,305</b>	ud	50	BOLSA	8431927024411
31042120	RACOR RA 90 M20 (DN10) GRIS	0104	1108	<b>4,305</b>	ud	50	BOLSA	8431927024428
31042216	RACOR RA 90 M16 (DN12) GRIS	0104	1108	<b>2,925</b>	ud	50	BOLSA	8431927002495
31042220	RACOR RA 90 M20 (DN12) GRIS	0104	1108	<b>4,460</b>	ud	50	BOLSA	8431927024435
31042420	RACOR RA 90 M20 (DN17) GRIS	0104	1108	<b>2,946</b>	ud	50	BOLSA	8431927002501
31042525	RACOR RA 90 M25 (DN23) GRIS	0104	1108	<b>4,893</b>	ud	30	BOLSA	8431927002518
31042632	RACOR RA 90 M32 (DN29) GRIS	0104	1108	<b>7,014</b>	ud	30	BOLSA	8431927002525
31042740	RACOR RA 90 M40 (DN36) GRIS	0104	1108	<b>11,588</b>	ud	10	BOLSA	8431927024442
31042850	RACOR RA 90 M50 (DN48) GRIS	0104	1108	<b>13,073</b>	ud	10	BOLSA	8431927024459

## RACOR RA 90 Métrica NEGRO IP67 (BAJO PEDIDO)



Ref.	Descripción	SERIE	GTV	€/ud	Unidad Venta	Unidad Embala.	Embalaje	Código EAN
32042012	RACOR RA 90 M12 (DN 7) NEGR	0104	1108	<b>3,090</b>	ud	50	BOLSA	8431927024466
32042016	RACOR RA 90 M16 (DN 7) NEGR	0104	1108	<b>3,193</b>	ud	50	BOLSA	8431927024473
32042020	RACOR RA 90 M20 (DN 7) NEGR	0104	1108	<b>3,193</b>	ud	50	BOLSA	8431927024480
32042116	RACOR RA 90 M16 (DN10) NEGR	0104	1108	<b>4,305</b>	ud	50	BOLSA	8431927024497
32042120	RACOR RA 90 M20 (DN10) NEGR	0104	1108	<b>4,305</b>	ud	50	BOLSA	8431927024503
32042216	RACOR RA 90 M16 (DN12) NEGR	0104	1108	<b>2,925</b>	ud	50	BOLSA	8431927024510
32042120	RACOR RA 90 M20 (DN12) NEGR	0104	1108	<b>4,130</b>	ud	50	BOLSA	8431927003553
32042420	RACOR RA 90 M20 (DN17) NEGR	0104	1108	<b>2,946</b>	ud	50	BOLSA	8431927003560
32042525	RACOR RA 90 M25 (DN23) NEGR	0104	1108	<b>4,893</b>	ud	30	BOLSA	8431927003577
32042632	RACOR RA 90 M32 (DN29) NEGR	0104	1108	<b>7,014</b>	ud	30	BOLSA	8431927003584
32042740	RACOR RA 90 M40 (DN36) NEGR	0104	1108	<b>11,588</b>	ud	10	BOLSA	8431927024527
32042850	RACOR RA 90 M50 (DN48) NEGR	0104	1108	<b>13,073</b>	ud	10	BOLSA	8431927024534

**RACOR RA 90 PG GRIS IP67**

Ref.	Descripción	SERIE	GTV	€/ud	Unidad Venta	Unidad Embala.	Embalaje	Código EAN
31040007	RACOR RA 90 PG 7 (DN 7) GRIS	0104	1108	<b>2,915</b>	ud	50	BOLSA	8431927002372
31040107	RACOR RA 90 PG 7 (DN10) GRIS	0104	1108	<b>2,915</b>	ud	50	BOLSA	8431927002389
31040109	RACOR RA 90 PG 9 (DN10) GRIS	0104	1108	<b>2,925</b>	ud	50	BOLSA	8431927002396
31040111	RACOR RA 90 PG11 (DN10) GRIS	0104	1108	<b>2,925</b>	ud	50	BOLSA	8431927002402
31040113	RACOR RA 90 PG13 (DN10) GRIS	0104	1108	<b>2,925</b>	ud	50	BOLSA	8431927024541
31040209	RACOR RA 90 PG 9 (DN12) GRIS	0104	1108	<b>2,925</b>	ud	50	BOLSA	8431927024558
31040211	RACOR RA 90 PG11 (DN12) GRIS	0104	1108	<b>2,925</b>	ud	50	BOLSA	8431927002419
31040213	RACOR RA 90 PG13 (DN12) GRIS	0104	1108	<b>2,925</b>	ud	50	BOLSA	8431927002426
31040413	RACOR RA 90 PG13 (DN17) GRIS	0104	1108	<b>2,946</b>	ud	50	BOLSA	8431927002433
31040416	RACOR RA 90 PG16 (DN17) GRIS	0104	1108	<b>2,946</b>	ud	50	BOLSA	8431927002440
31040521	RACOR RA 90 PG21 (DN23) GRIS	0104	1108	<b>4,893</b>	ud	30	BOLSA	8431927002457
31040629	RACOR RA 90 PG29 (DN29) GRIS	0104	1108	<b>7,014</b>	ud	30	BOLSA	8431927002464
31040736	RACOR RA 90 PG36 (DN36) GRIS	0104	1108	<b>11,588</b>	ud	10	BOLSA	8431927002471
31040848	RACOR RA 90 PG48 (DN48) GRIS	0104	1108	<b>12,947</b>	ud	10	BOLSA	8431927002488

**RACOR RA 90 PG NEGRO IP67 (BAJO PEDIDO)**

Ref.	Descripción	SERIE	GTV	€/ud	Unidad Venta	Unidad Embala.	Embalaje	Código EAN
32040007	RACOR RA 90 PG 7 (DN 7) NEGR	0104	1108	<b>2,915</b>	ud	50	BOLSA	8431927003430
32040107	RACOR RA 90 PG 7 (DN10) NEGR	0104	1108	<b>2,915</b>	ud	50	BOLSA	8431927003447
32040109	RACOR RA 90 PG 9 (DN10) NEGR	0104	1108	<b>2,925</b>	ud	50	BOLSA	8431927003454
32040111	RACOR RA 90 PG11 (DN10) NEGR	0104	1108	<b>2,925</b>	ud	50	BOLSA	8431927003461
32040113	RACOR RA 90 PG13 (DN10) NEGR	0104	1108	<b>2,925</b>	ud	50	BOLSA	8431927024565
32040209	RACOR RA 90 PG 9 (DN12) NEGR	0104	1108	<b>2,925</b>	ud	50	BOLSA	8431927024572
32040211	RACOR RA 90 PG11 (DN12) NEGR	0104	1108	<b>2,925</b>	ud	50	BOLSA	8431927003478
32040213	RACOR RA 90 PG13 (DN12) NEGR	0104	1108	<b>2,925</b>	ud	50	BOLSA	8431927003485
32040413	RACOR RA 90 PG13 (DN17) NEGR	0104	1108	<b>2,946</b>	ud	50	BOLSA	8431927003492
32040416	RACOR RA 90 PG16 (DN17) NEGR	0104	1108	<b>2,946</b>	ud	50	BOLSA	8431927003508
32040521	RACOR RA 90 PG21 (DN23) NEGR	0104	1108	<b>4,893</b>	ud	30	BOLSA	8431927003515
32040629	RACOR RA 90 PG29 (DN29) NEGR	0104	1108	<b>7,014</b>	ud	30	BOLSA	8431927003522
32040736	RACOR RA 90 PG36 (DN36) NEGR	0104	1108	<b>11,588</b>	ud	10	BOLSA	8431927003539
32040848	RACOR RA 90 PG48 (DN48) NEGR	0104	1108	<b>12,947</b>	ud	10	BOLSA	8431927003546

**RACOR RAP 45 Métrica GRIS IP67**

Ref.	Descripción	SERIE	GTV	€/ud	Unidad Venta	Unidad Embala.	Embalaje	Código EAN
31120116	RACOR RAP 45 M16 (DN10) GRIS	0104	1108	<b>4,120</b>	ud	50	BOLSA	8431927024589
31120120	RACOR RAP 45 M20 (DN10) GRIS	0104	1108	<b>4,120</b>	ud	50	BOLSA	8431927024596
31120216	RACOR RAP 45 M16 (DN12) GRIS	0104	1108	<b>4,202</b>	ud	50	BOLSA	8431927040824
31120220	RACOR RAP 45 M20 (DN12) GRIS	0104	1108	<b>4,285</b>	ud	50	BOLSA	8431927024602
31120420	RACOR RAP 45 M20 (DN17) GRIS	0104	1108	<b>4,285</b>	ud	50	BOLSA	8431927024619
31120425	RACOR RAP 45 M25 (DN17) GRIS	0104	1108	<b>4,285</b>	ud	50	BOLSA	8431927024626
31120525	RACOR RAP 45 M25 (DN23) GRIS	0104	1108	<b>8,477</b>	ud	30	BOLSA	8431927040831
31120532	RACOR RAP 45 M32 (DN23) GRIS	0104	1108	<b>8,982</b>	ud	30	BOLSA	8431927024633
31120632	RACOR RAP 45 M32 (DN29) GRIS	0104	1108	<b>12,092</b>	ud	30	BOLSA	8431927040848
31120640	RACOR RAP 45 M40 (DN29) GRIS	0104	1108	<b>12,803</b>	ud	30	BOLSA	8431927024640
31120740	RACOR RAP 45 M40 (DN36) GRIS	0104	1108	<b>18,530</b>	ud	10	BOLSA	8431927040855
31120750	RACOR RAP 45 M50 (DN36) GRIS	0104	1108	<b>19,622</b>	ud	10	BOLSA	8431927024657
31120850	RACOR RAP 45 M50 (DN48) GRIS	0104	1108	<b>20,425</b>	ud	10	BOLSA	8431927040862
31120863	RACOR RAP 45 M63 (DN48) GRIS	0104	1108	<b>21,630</b>	ud	10	BOLSA	8431927024664

**RACOR RAP 45 Métrica NEGRO IP67 (BAJO PEDIDO)**

Ref.	Descripción	SERIE	GTV	€/ud	Unidad Venta	Unidad Embala.	Embalaje	Código EAN
32120116	RACOR RAP 45 M16 (DN10) NEGR	0104	1108	<b>4,120</b>	ud	50	BOLSA	8431927024671
32120120	RACOR RAP 45 M16 (DN12) NEGR	0104	1108	<b>4,120</b>	ud	50	BOLSA	8431927024688
32120216	RACOR RAP 45 M20 (DN10) NEGR	0104	1108	<b>4,202</b>	ud	50	BOLSA	8431927040770
32120220	RACOR RAP 45 M20 (DN12) NEGR	0104	1108	<b>4,285</b>	ud	50	BOLSA	8431927024695
32120420	RACOR RAP 45 M20 (DN17) NEGR	0104	1108	<b>4,285</b>	ud	50	BOLSA	8431927024701
32120425	RACOR RAP 45 M25 (DN17) NEGR	0104	1108	<b>4,285</b>	ud	50	BOLSA	8431927024718
32120525	RACOR RAP 45 M25 (DN23) NEGR	0104	1108	<b>8,477</b>	ud	30	BOLSA	8431927040787
32120532	RACOR RAP 45 M32 (DN23) NEGR	0104	1108	<b>8,982</b>	ud	30	BOLSA	8431927024725
32120632	RACOR RAP 45 M32 (DN29) NEGR	0104	1108	<b>12,092</b>	ud	30	BOLSA	8431927040794
32120640	RACOR RAP 45 M40 (DN29) NEGR	0104	1108	<b>12,803</b>	ud	30	BOLSA	8431927024732
32120740	RACOR RAP 45 M40 (DN36) NEGR	0104	1108	<b>18,530</b>	ud	10	BOLSA	8431927040800
32120750	RACOR RAP 45 M50 (DN36) NEGR	0104	1108	<b>19,622</b>	ud	10	BOLSA	8431927024749
32120850	RACOR RAP 45 M50 (DN48) NEGR	0104	1108	<b>20,425</b>	ud	10	BOLSA	8431927040817
32120863	RACOR RAP 45 M63 (DN48) NEGR	0104	1108	<b>21,630</b>	ud	10	BOLSA	8431927024756

**RACOR RAM 45 Métrica GRIS IP67**

Ref.	Descripción	SERIE	GTV	€/ud	Unidad Venta	Unidad Embala.	Embalaje	Código EAN
31121116	RACOR RAM 45 M16 (DN10) GRIS	0104	1108	<b>8,333</b>	ud	30	BOLSA	8431927024763
31121120	RACOR RAM 45 M20 (DN10) GRIS	0104	1108	<b>8,333</b>	ud	30	BOLSA	8431927024770
31121216	RACOR RAM 45 M16 (DN12) GRIS	0104	1108	<b>9,538</b>	ud	30	BOLSA	8431927041272
31121220	RACOR RAM 45 M20 (DN12) GRIS	0104	1108	<b>9,002</b>	ud	30	BOLSA	8431927024787
31121420	RACOR RAM 45 M20 (DN17) GRIS	0104	1108	<b>10,104</b>	ud	30	BOLSA	8431927024794
31121425	RACOR RAM 45 M25 (DN17) GRIS	0104	1108	<b>10,104</b>	ud	30	BOLSA	8431927024800
31121532	RACOR RAM 45 M32 (DN23) GRIS	0104	1108	<b>16,532</b>	ud	30	BOLSA	8431927024817
31121632	RACOR RAM 45 M32 (DN29) GRIS	0104	1108	<b>21,094</b>	ud	20	BOLSA	8431927041289
31121640	RACOR RAM 45 M40 (DN29) GRIS	0104	1108	<b>21,331</b>	ud	20	BOLSA	8431927024824
31121740	RACOR RAM 45 M40 (DN36) GRIS	0104	1108	<b>36,833</b>	ud	10	BOLSA	8431927041296
31121750	RACOR RAM 45 M50 (DN36) GRIS	0104	1108	<b>34,742</b>	ud	10	BOLSA	8431927024831
31121863	RACOR RAM 45 M63 (DN48) GRIS	0104	1108	<b>47,308</b>	ud	10	BOLSA	8431927024848

**RACOR RAM 45 Métrica NEGRO IP67 (BAJO PEDIDO)**

Ref.	Descripción	SERIE	GTV	€/ud	Unidad Venta	Unidad Embala.	Embalaje	Código EAN
32121116	RACOR RAM 45 M16 (DN10) NEGR	0104	1108	<b>8,333</b>	ud	30	BOLSA	8431927024855
32121120	RACOR RAM 45 M20 (DN10) NEGR	0104	1108	<b>8,333</b>	ud	30	BOLSA	8431927024862
32121216	RACOR RAM 45 M16 (DN12) NEGR	0104	1108	<b>9,538</b>	ud	30	BOLSA	8431927041241
32121220	RACOR RAM 45 M20 (DN12) NEGR	0104	1108	<b>9,002</b>	ud	30	BOLSA	8431927024879
32121420	RACOR RAM 45 M20 (DN17) NEGR	0104	1108	<b>10,104</b>	ud	30	BOLSA	8431927024886
32121425	RACOR RAM 45 M25 (DN17) NEGR	0104	1108	<b>10,104</b>	ud	30	BOLSA	8431927024893
32121532	RACOR RAM 45 M32 (DN23) NEGR	0104	1108	<b>16,532</b>	ud	30	BOLSA	8431927024909
32121632	RACOR RAM 45 M32 (DN29) NEGR	0104	1108	<b>21,094</b>	ud	20	BOLSA	8431927041258
32121640	RACOR RAM 45 M40 (DN29) NEGR	0104	1108	<b>21,331</b>	ud	20	BOLSA	8431927024916
32121740	RACOR RAM 45 M40 (DN36) NEGR	0104	1108	<b>36,833</b>	ud	10	BOLSA	8431927041265
32121750	RACOR RAM 45 M50 (DN36) NEGR	0104	1108	<b>34,742</b>	ud	10	BOLSA	8431927024923
32121863	RACOR RAM 45 M63 (DN48) NEGR	0104	1108	<b>47,308</b>	ud	10	BOLSA	8431927024930

**RACOR RAP 90 Métrica GRIS IP67**

Ref.	Descripción	SERIE	GTV	€/ud	Unidad Venta	Unidad Embala.	Embalaje	Código EAN
31130116	RACOR RAP 90 M16 (DN10) GRIS	0104	1108	<b>4,120</b>	ud	50	BOLSA	8431927024947
31130120	RACOR RAP 90 M20 (DN10) GRIS	0104	1108	<b>4,120</b>	ud	50	BOLSA	8431927024954
31130216	RACOR RAP 90 M16 (DN12) GRIS	0104	1108	<b>4,202</b>	ud	50	BOLSA	8431927040947
31130220	RACOR RAP 90 M20 (DN12) GRIS	0104	1108	<b>4,285</b>	ud	50	BOLSA	8431927024961
31130420	RACOR RAP 90 M20 (DN17) GRIS	0104	1108	<b>4,285</b>	ud	50	BOLSA	8431927024978
31130425	RACOR RAP 90 M25 (DN17) GRIS	0104	1108	<b>4,285</b>	ud	50	BOLSA	8431927024985
31130525	RACOR RAP 90 M25 (DN23) GRIS	0104	1108	<b>8,477</b>	ud	30	BOLSA	8431927040954
31130532	RACOR RAP 90 M32 (DN23) GRIS	0104	1108	<b>8,982</b>	ud	30	BOLSA	8431927024992
31130632	RACOR RAP 90 M32 (DN29) GRIS	0104	1108	<b>12,123</b>	ud	30	BOLSA	8431927040961
31130640	RACOR RAP 90 M40 (DN29) GRIS	0104	1108	<b>12,803</b>	ud	30	BOLSA	8431927025005
31130740	RACOR RAP 90 M40 (DN36) GRIS	0104	1108	<b>18,530</b>	ud	10	BOLSA	8431927040978
31130750	RACOR RAP 90 M50 (DN36) GRIS	0104	1108	<b>19,622</b>	ud	10	BOLSA	8431927025012
31130850	RACOR RAP 90 M50 (DN48) GRIS	0104	1108	<b>20,425</b>	ud	10	BOLSA	8431927040985
31130863	RACOR RAP 90 M63 (DN48) GRIS	0104	1108	<b>21,630</b>	ud	10	BOLSA	8431927025029

**RACOR RAP 90 Métrica NEGRO IP67 (BAJO PEDIDO)**

Ref.	Descripción	SERIE	GTV	€/ud	Unidad Venta	Unidad Embala.	Embalaje	Código EAN
32130116	RACOR RAP 90 M16 (DN10) NEGR	0104	1108	<b>4,120</b>	ud	50	BOLSA	8431927025036
32130120	RACOR RAP 90 M20 (DN10) NEGR	0104	1108	<b>4,120</b>	ud	50	BOLSA	8431927025043
32130216	RACOR RAP 90 M16 (DN12) NEGR	0104	1108	<b>4,202</b>	ud	50	BOLSA	8431927040893
32130220	RACOR RAP 90 M20 (DN12) NEGR	0104	1108	<b>4,285</b>	ud	50	BOLSA	8431927025050
32130420	RACOR RAP 90 M20 (DN17) NEGR	0104	1108	<b>4,285</b>	ud	50	BOLSA	8431927025067
32130425	RACOR RAP 90 M25 (DN17) NEGR	0104	1108	<b>4,285</b>	ud	50	BOLSA	8431927025074
32130525	RACOR RAP 90 M25 (DN23) NEGR	0104	1108	<b>8,477</b>	ud	30	BOLSA	8431927040909
32130532	RACOR RAP 90 M32 (DN23) NEGR	0104	1108	<b>8,982</b>	ud	30	BOLSA	8431927025081
32130632	RACOR RAP 90 M32 (DN29) NEGR	0104	1108	<b>12,123</b>	ud	30	BOLSA	8431927040916
32130640	RACOR RAP 90 M40 (DN29) NEGR	0104	1108	<b>12,803</b>	ud	30	BOLSA	8431927025098
32130740	RACOR RAP 90 M40 (DN36) NEGR	0104	1108	<b>18,530</b>	ud	10	BOLSA	8431927040923
32130750	RACOR RAP 90 M50 (DN36) NEGR	0104	1108	<b>19,622</b>	ud	10	BOLSA	8431927025104
32130850	RACOR RAP 90 M50 (DN48) NEGR	0104	1108	<b>20,425</b>	ud	10	BOLSA	8431927040930
32130863	RACOR RAP 90 M63 (DN48) NEGR	0104	1108	<b>21,630</b>	ud	10	BOLSA	8431927025111

**RACOR RAM 90 Métrica GRIS IP67**

Ref.	Descripción	SERIE	GTV	€/ud	Unidad Venta	Unidad Embala.	Embalaje	Código EAN
31131116	RACOR RAM 90 M16 (DN10) GRIS	0104	1108	<b>8,322</b>	ud	30	BOLSA	8431927025128
31131120	RACOR RAM 90 M20 (DN10) GRIS	0104	1108	<b>8,322</b>	ud	30	BOLSA	8431927025135
31131216	RACOR RAM 90 M16 (DN12) GRIS	0104	1108	<b>9,538</b>	ud	30	BOLSA	8431927041210
31131220	RACOR RAM 90 M20 (DN12) GRIS	0104	1108	<b>9,002</b>	ud	30	BOLSA	8431927025142
31131420	RACOR RAM 90 M20 (DN17) GRIS	0104	1108	<b>10,104</b>	ud	30	BOLSA	8431927025159
31131425	RACOR RAM 90 M25 (DN17) GRIS	0104	1108	<b>10,104</b>	ud	30	BOLSA	8431927025166
31131532	RACOR RAM 90 M32 (DN23) GRIS	0104	1108	<b>16,532</b>	ud	30	BOLSA	8431927025173
31131632	RACOR RAM 90 M32 (DN29) GRIS	0104	1108	<b>21,094</b>	ud	20	BOLSA	8431927041227
31131640	RACOR RAM 90 M40 (DN29) GRIS	0104	1108	<b>21,331</b>	ud	20	BOLSA	8431927025180
31131740	RACOR RAM 90 M40 (DN36) GRIS	0104	1108	<b>36,833</b>	ud	10	BOLSA	8431927041234
31131750	RACOR RAM 90 M50 (DN36) GRIS	0104	1108	<b>34,742</b>	ud	10	BOLSA	8431927025197
31131863	RACOR RAM 90 M63 (DN48) GRIS	0104	1108	<b>47,308</b>	ud	10	BOLSA	8431927025203

**RACOR RAM 90 Métrica NEGRO IP67 (BAJO PEDIDO)**

Ref.	Descripción	SERIE	GTV	€/ud	Unidad Venta	Unidad Embala.	Embalaje	Código EAN
32131116	RACOR RAM 90 M16 (DN10) NEGR	0104	1108	<b>8,322</b>	ud	30	BOLSA	8431927025210
32131120	RACOR RAM 90 M20 (DN10) NEGR	0104	1108	<b>8,322</b>	ud	30	BOLSA	8431927025227
32131216	RACOR RAM 90 M16 (DN12) NEGR	0104	1108	<b>9,538</b>	ud	30	BOLSA	8431927041180
32131220	RACOR RAM 90 M20 (DN12) NEGR	0104	1108	<b>9,002</b>	ud	30	BOLSA	8431927025234
32131420	RACOR RAM 90 M20 (DN17) NEGR	0104	1108	<b>10,104</b>	ud	30	BOLSA	8431927025241
32131425	RACOR RAM 90 M25 (DN17) NEGR	0104	1108	<b>10,104</b>	ud	30	BOLSA	8431927025258
32131532	RACOR RAM 90 M32 (DN23) NEGR	0104	1108	<b>16,532</b>	ud	30	BOLSA	8431927025265
32131632	RACOR RAM 90 M32 (DN29) NEGR	0104	1108	<b>21,094</b>	ud	20	BOLSA	8431927041197
32131640	RACOR RAM 90 M40 (DN29) NEGR	0104	1108	<b>21,331</b>	ud	20	BOLSA	8431927025272
32131740	RACOR RAM 90 M40 (DN36) NEGR	0104	1108	<b>36,833</b>	ud	10	BOLSA	8431927041203
32131750	RACOR RAM 90 M50 (DN36) NEGR	0104	1108	<b>34,742</b>	ud	10	BOLSA	8431927025289
32131863	RACOR RAM 90 M63 (DN48) NEGR	0104	1108	<b>47,308</b>	ud	10	BOLSA	8431927025296

## RACORES PRENSAESTOPAS

**RACOR RPP PG GRIS IP67 (BAJO PEDIDO)**

Ref.	Descripción	SERIE	GTV	€/ud	Unidad Venta	Unidad Embala.	Embalaje	Código EAN
31070007	RACOR RPP PG 7 (DN 7) GRIS	0104	1108	<b>8,559</b>	ud	30	BOLSA	8431927002709
31070109	RACOR RPP PG 9 (DN10) GRIS	0104	1108	<b>10,290</b>	ud	30	BOLSA	8431927002716
31070211	RACOR RPP PG11 (DN12) GRIS	0104	1108	<b>10,805</b>	ud	30	BOLSA	8431927002723
31070213	RACOR RPP PG13 (DN12) GRIS	0104	1108	<b>10,805</b>	ud	30	BOLSA	8431927002730
31070416	RACOR RPP PG16 (DN17) GRIS	0104	1108	<b>12,865</b>	ud	30	BOLSA	8431927002747
31070521	RACOR RPP PG21 (DN23) GRIS	0104	1108	<b>15,635</b>	ud	30	BOLSA	8431927002754
31070629	RACOR RPP PG29 (DN29) GRIS	0104	1108	<b>20,631</b>	ud	20	BOLSA	8431927002761
31070736	RACOR RPP PG36 (DN36) GRIS	0104	1108	<b>38,862</b>	ud	10	BOLSA	8431927002778
31070848	RACOR RPP PG48 (DN48) GRIS	0104	1108	<b>44,589</b>	ud	10	BOLSA	8431927002785

**RACOR RPP Métrica GRIS IP67 (BAJO PEDIDO)**

Ref.	Descripción	SERIE	GTV	€/ud	Unidad Venta	Unidad Embala.	Embalaje	Código EAN
31072012	RACOR RPP M12 (DN 7) GRIS	0104	1108	<b>8,559</b>	ud	30	BOLSA	8431927025401
31072116	RACOR RPP M16 (DN10) GRIS	0104	1108	<b>10,290</b>	ud	30	BOLSA	8431927025418
31072216	RACOR RPP M16 (DN12) GRIS	0104	1108	<b>10,805</b>	ud	30	BOLSA	8431927025425
31072220	RACOR RPP M20 (DN12) GRIS	0104	1108	<b>10,805</b>	ud	30	BOLSA	8431927025432
31072420	RACOR RPP M20 (DN17) GRIS	0104	1108	<b>12,865</b>	ud	30	BOLSA	8431927025449
31072525	RACOR RPP M25 (DN23) GRIS	0104	1108	<b>15,635</b>	ud	30	BOLSA	8431927025456
31072632	RACOR RPP M32 (DN29) GRIS	0104	1108	<b>20,631</b>	ud	20	BOLSA	8431927025463
31072740	RACOR RPP M40 (DN36) GRIS	0104	1108	<b>38,862</b>	ud	10	BOLSA	8431927025470
31072863	RACOR RPP M63 (DN48) GRIS	0104	1108	<b>44,589</b>	ud	10	BOLSA	8431927025487

**RACOR RPP Métrica NEGR IP67 (BAJO PEDIDO)**

Ref.	Descripción	SERIE	GTV	€/ud	Unidad Venta	Unidad Embala.	Embalaje	Código EAN
32072012	RACOR RPP M12 (DN 7) NEGR	0104	1108	<b>8,559</b>	ud	30	BOLSA	8431927041036
32072116	RACOR RPP M16 (DN10) NEGR	0104	1108	<b>10,290</b>	ud	30	BOLSA	8431927041043
32072216	RACOR RPP M16 (DN12) NEGR	0104	1108	<b>10,805</b>	ud	30	BOLSA	8431927041050
32072220	RACOR RPP M20 (DN12) NEGR	0104	1108	<b>10,805</b>	ud	30	BOLSA	8431927041067
32072420	RACOR RPP M20 (DN17) NEGR	0104	1108	<b>12,865</b>	ud	30	BOLSA	8431927041074
32072525	RACOR RPP M25 (DN23) NEGR	0104	1108	<b>15,635</b>	ud	30	BOLSA	8431927041081
32072632	RACOR RPP M32 (DN29) NEGR	0104	1108	<b>20,631</b>	ud	20	BOLSA	8431927041098
32072740	RACOR RPP M40 (DN36) NEGR	0104	1108	<b>38,862</b>	ud	10	BOLSA	8431927041104
32072863	RACOR RPP M63 (DN48) NEGR	0104	1108	<b>44,589</b>	ud	10	BOLSA	8431927041111

**RACOR RPM PG GRIS IP67 (BAJO PEDIDO)**

Ref.	Descripción	SERIE	GTV	€/ud	Unidad Venta	Unidad Embala.	Embalaje	Código EAN
31080109	RACOR RPM PG 9 (DN10) GRIS	0104	1108	<b>19,838</b>	ud	30	BOLSA	8431927002792
31080211	RACOR RPM PG11 (DN12) GRIS	0104	1108	<b>21,712</b>	ud	30	BOLSA	8431927002808
31080213	RACOR RPM PG13 (DN12) GRIS	0104	1108	<b>24,442</b>	ud	30	BOLSA	8431927002815
31080416	RACOR RPM PG16 (DN17) GRIS	0104	1108	<b>46,762</b>	ud	30	BOLSA	8431927002822
31080521	RACOR RPM PG21 (DN23) GRIS	0104	1108	<b>56,022</b>	ud	30	BOLSA	8431927002839
31080629	RACOR RPM PG29 (DN29) GRIS	0104	1108	<b>73,254</b>	ud	20	BOLSA	8431927002846
31080736	RACOR RPM PG36 (DN36) GRIS	0104	1108	<b>97,448</b>	ud	10	BOLSA	8431927002853
31080848	RACOR RPM PG48 (DN48) GRIS	0104	1108	<b>143,252</b>	ud	10	BOLSA	8431927002860

**RACOR RPM Métrica GRIS IP67 (BAJO PEDIDO)**

Ref.	Descripción	SERIE	GTV	€/ud	Unidad Venta	Unidad Embala.	Embalaje	Código EAN
31082012	RACOR RPM M12 (DN 7) GRIS	0104	1108	<b>19,838</b>	ud	30	BOLSA	8431927041395
31082116	RACOR RPM M16 (DN10) GRIS	0104	1108	<b>19,838</b>	ud	30	BOLSA	8431927041401
31082216	RACOR RPM M16 (DN12) GRIS	0104	1108	<b>21,712</b>	ud	30	BOLSA	8431927041418
31082220	RACOR RPM M20 (DN12) GRIS	0104	1108	<b>24,442</b>	ud	30	BOLSA	8431927041425
31082420	RACOR RPM M20 (DN17) GRIS	0104	1108	<b>46,762</b>	ud	30	BOLSA	8431927041432
31082525	RACOR RPM M25 (DN23) GRIS	0104	1108	<b>56,022</b>	ud	20	BOLSA	8431927041449
31082632	RACOR RPM M32 (DN29) GRIS	0104	1108	<b>73,254</b>	ud	10	BOLSA	8431927041456
31082740	RACOR RPM M40 (DN36) GRIS	0104	1108	<b>97,448</b>	ud	10	BOLSA	8431927041463
31082863	RACOR RPM M63 (DN48) GRIS	0104	1108	<b>143,252</b>	ud	10	BOLSA	8431927041470

**RACOR RPM Métrica NEGR IP67 (BAJO PEDIDO)**

Ref.	Descripción	SERIE	GTV	€/ud	Unidad Venta	Unidad Embala.	Embalaje	Código EAN
32082012	RACOR RPM M12 (DN 7) NEGR	0104	1108	<b>19,838</b>	ud	10	BOLSA	8431927041302
32082116	RACOR RPM M16 (DN10) NEGR	0104	1108	<b>19,838</b>	ud	10	BOLSA	8431927041319
32082216	RACOR RPM M16 (DN12) NEGR	0104	1108	<b>21,712</b>	ud	10	BOLSA	8431927041326
32082220	RACOR RPM M20 (DN12) NEGR	0104	1108	<b>24,442</b>	ud	10	BOLSA	8431927041333
32082420	RACOR RPM M20 (DN17) NEGR	0104	1108	<b>46,762</b>	ud	10	BOLSA	8431927041340
32082525	RACOR RPM M25 (DN23) NEGR	0104	1108	<b>56,022</b>	ud	10	BOLSA	8431927041357
32082632	RACOR RPM M32 (DN29) NEGR	0104	1108	<b>73,254</b>	ud	10	BOLSA	8431927041364
32082740	RACOR RPM M40 (DN36) NEGR	0104	1108	<b>97,448</b>	ud	10	BOLSA	8431927041371
32082863	RACOR RPM M63 (DN48) NEGR	0104	1108	<b>143,252</b>	ud	10	BOLSA	8431927041388

# DERIVACIONES

**DERIVACIÓN DY GRIS**

Ref.	Descripción	SERIE	GTV	€/ud	Unidad Venta	Unidad Embala.	Embalaje	Código EAN
31060100	DERIVACION DY DN10X 7X 7 GRIS	0104	1108	<b>6,458</b>	ud	10	BOLSA	8431927002587
31060111	DERIVACION DY DN10X10X10 GRIS	0104	1108	<b>6,458</b>	ud	10	BOLSA	8431927002594
31060211	DERIVACION DY DN12X10X10 GRIS	0104	1108	<b>6,458</b>	ud	10	BOLSA	8431927002600
31060422	DERIVACION DY DN17X12X12 GRIS	0104	1108	<b>6,458</b>	ud	10	BOLSA	8431927002617
31060444	DERIVACION DY DN17X17X17 GRIS	0104	1108	<b>6,458</b>	ud	10	BOLSA	8431927002624
31060544	DERIVACION DY DN23X17X17 GRIS	0104	1108	<b>11,042</b>	ud	10	BOLSA	8431927002631

**DERIVACIÓN DY NEGRO (BAJO PEDIDO)**

Ref.	Descripción	SERIE	GTV	€/ud	Unidad Venta	Unidad Embala.	Embalaje	Código EAN
32060100	DERIVACION DY DN10X 7X 7 NEGR	0104	1108	<b>6,458</b>	ud	10	BOLSA	8431927003645
32060111	DERIVACION DY DN10X10X10 NEGR	0104	1108	<b>6,458</b>	ud	10	BOLSA	8431927003652
32060211	DERIVACION DY DN12X10X10 NEGR	0104	1108	<b>6,458</b>	ud	10	BOLSA	8431927003669
32060422	DERIVACION DY DN17X12X12 NEGR	0104	1108	<b>6,458</b>	ud	10	BOLSA	8431927003676
32060444	DERIVACION DY DN17X17X17 NEGR	0104	1108	<b>6,458</b>	ud	10	BOLSA	8431927003683
32060544	DERIVACION DY DN23X17X17 NEGR	0104	1108	<b>11,042</b>	ud	10	BOLSA	8431927003690

**DERIVACIÓN DT GRIS**

Ref.	Descripción	SERIE	GTV	€/ud	Unidad Venta	Unidad Embala.	Embalaje	Código EAN
31065111	DERIVACION DT DN10X10X10 GRIS	0104	1108	<b>6,458</b>	ud	10	BOLSA	8431927002648
31065211	DERIVACION DT DN12X10X10 GRIS	0104	1108	<b>6,458</b>	ud	10	BOLSA	8431927002655
31065422	DERIVACION DT DN17X12X12 GRIS	0104	1108	<b>6,458</b>	ud	10	BOLSA	8431927002662
31065444	DERIVACION DT DN17X17X17 GRIS	0104	1108	<b>6,458</b>	ud	10	BOLSA	8431927002679
31065655	DERIVACION DT DN29X23X23 GRIS	0104	1108	<b>13,060</b>	ud	10	BOLSA	8431927002686
31065666	DERIVACION DT DN29X29X29 GRIS	0104	1108	<b>13,153</b>	ud	10	BOLSA	8431927002693

**DERIVACIÓN DT NEGRO (BAJO PEDIDO)**

Ref.	Descripción	SERIE	GTV	€/ud	Unidad Venta	Unidad Embala.	Embalaje	Código EAN
32065111	DERIVACION DT DN10X10X10 NEGR	0104	1108	<b>6,458</b>	ud	10	BOLSA	8431927003706
32065211	DERIVACION DT DN12X10X10 NEGR	0104	1108	<b>6,458</b>	ud	10	BOLSA	8431927003713
32065422	DERIVACION DT DN17X12X12 NEGR	0104	1108	<b>6,458</b>	ud	10	BOLSA	8431927003720
32065444	DERIVACION DT DN17X17X17 NEGR	0104	1108	<b>6,458</b>	ud	10	BOLSA	8431927003737
32065655	DERIVACION DT DN29X23X23 NEGR	0104	1108	<b>13,060</b>	ud	10	BOLSA	8431927003744
32065666	DERIVACION DT DN29X29X29 NEGR	0104	1108	<b>13,153</b>	ud	10	BOLSA	8431927003751

## ACCESORIOS. JUNTAS DE ESTANQUEIDAD

**JUNTA EXTERIOR PG**

Ref.	Descripción	SERIE	GTV	€/ud	Unidad Venta	Unidad Embala.	Embalaje	Código EAN
39092007	JUNTA EXTERIOR PG 7	0104	1108	<b>0,345</b>	ud	100	BOLSA	8431927005175
39092009	JUNTA EXTERIOR PG 9	0104	1108	<b>0,345</b>	ud	100	BOLSA	8431927005182
39092011	JUNTA EXTERIOR PG11	0104	1108	<b>0,368</b>	ud	100	BOLSA	8431927005199
39092013	JUNTA EXTERIOR PG13	0104	1108	<b>0,414</b>	ud	50	BOLSA	8431927005205
39092016	JUNTA EXTERIOR PG16	0104	1108	<b>0,437</b>	ud	50	BOLSA	8431927005212
39092021	JUNTA EXTERIOR PG21	0104	1108	<b>0,518</b>	ud	50	BOLSA	8431927005229
39092029	JUNTA EXTERIOR PG29	0104	1108	<b>0,756</b>	ud	30	BOLSA	8431927005236
39092036	JUNTA EXTERIOR PG36	0104	1108	<b>0,975</b>	ud	10	BOLSA	8431927005243
39092048	JUNTA EXTERIOR PG48	0104	1108	<b>1,350</b>	ud	10	BOLSA	8431927005250

**JUNTA EXTERIOR Métrica**

Ref.	Descripción	SERIE	GTV	€/ud	Unidad Venta	Unidad Embala.	Embalaje	Código EAN
39092112	JUNTA EXTERIOR M12	0104	1108	<b>0,345</b>	ud	50	BOLSA	8431927021663
39092116	JUNTA EXTERIOR M16	0104	1108	<b>0,368</b>	ud	50	BOLSA	8431927021670
39092120	JUNTA EXTERIOR M20	0104	1108	<b>0,460</b>	ud	50	BOLSA	8431927021687
39092125	JUNTA EXTERIOR M25	0104	1108	<b>0,518</b>	ud	50	BOLSA	8431927021694
39092132	JUNTA EXTERIOR M32	0104	1108	<b>0,725</b>	ud	30	BOLSA	8431927021700
39092140	JUNTA EXTERIOR M40	0104	1108	<b>1,093</b>	ud	10	BOLSA	8431927021717
39092150	JUNTA EXTERIOR M50	0104	1108	<b>1,553</b>	ud	10	BOLSA	8431927021724
39092163	JUNTA EXTERIOR M63	0104	1108	<b>2,314</b>	ud	10	BOLSA	8431927021731

**JUNTA INTERIOR**

Ref.	Descripción	SERIE	GTV	€/ud	Unidad Venta	Unidad Embala.	Embalaje	Código EAN
39091000	JUNTA INT DN 7	0104	1108	<b>0,414</b>	ud	50	BOLSA	8431927005090
39091100	JUNTA INT DN10	0104	1108	<b>0,437</b>	ud	50	BOLSA	8431927005106
39091200	JUNTA INT DN12	0104	1108	<b>0,460</b>	ud	50	BOLSA	8431927005113
39091400	JUNTA INT DN17	0104	1108	<b>0,495</b>	ud	50	BOLSA	8431927005120
39091500	JUNTA INT DN23	0104	1108	<b>0,819</b>	ud	30	BOLSA	8431927005137
39091600	JUNTA INT DN29	0104	1108	<b>1,019</b>	ud	30	BOLSA	8431927005144
39091700	JUNTA INT DN36	0104	1108	<b>1,575</b>	ud	10	BOLSA	8431927005151
39091800	JUNTA INT DN48	0104	1108	<b>1,953</b>	ud	10	BOLSA	8431927005168

# SISTEMA PEMSAFLEX ROBÓTICA

## TUBO FLEXIBLE RB-PA GRIS



Ref.	Descripción	SERIE	GTV	€/m	Unidad Venta	Unidad Embala.	Embalaje	Código EAN
10046007	TUBO FLEXIBLE RB-PA DN 7 GRIS	0104	1006	<b>4,779</b>	m	100	ROLLO	8431927040688
10046010	TUBO FLEXIBLE RB-PA DN10 GRIS	0104	1006	<b>4,903</b>	m	50	ROLLO	8431927040695
10046012	TUBO FLEXIBLE RB-PA DN12 GRIS	0104	1006	<b>6,726</b>	m	50	ROLLO	8431927040701
10046017	TUBO FLEXIBLE RB-PA DN17 GRIS	0104	1006	<b>10,455</b>	m	50	ROLLO	8431927016386
10046023	TUBO FLEXIBLE RB-PA DN23 GRIS	0104	1006	<b>14,863</b>	m	50	ROLLO	8431927016393
10046029	TUBO FLEXIBLE RB-PA DN29 GRIS	0104	1006	<b>18,828</b>	m	50	ROLLO	8431927016409
10046036	TUBO FLEXIBLE RB-PA DN36 GRIS	0104	1006	<b>24,246</b>	m	30	ROLLO	8431927022493
10046048	TUBO FLEXIBLE RB-PA DN48 GRIS	0104	1006	<b>34,443</b>	m	30	ROLLO	8431927022509
10046052	TUBO FLEXIBLE RB-PA DN52 GRIS	0104	1006	<b>50,872</b>	m	30	ROLLO	8431927022516
10046070	TUBO FLEXIBLE RB-PA DN70 GRIS	0104	1006	<b>92,041</b>	m	30	ROLLO	8431927022523

## TUBO FLEXIBLE RB-PA NEGRO (BAJO PEDIDO)



Ref.	Descripción	SERIE	GTV	€/m	Unidad Venta	Unidad Embala.	Embalaje	Código EAN
10047007	TUBO FLEXIBLE RB-PA DN 7 NEGR	0104	1006	<b>4,779</b>	m	100	ROLLO	8431927040718
10047010	TUBO FLEXIBLE RB-PA DN10 NEGR	0104	1006	<b>4,903</b>	m	50	ROLLO	8431927040725
10047012	TUBO FLEXIBLE RB-PA DN12 NEGR	0104	1006	<b>6,726</b>	m	50	ROLLO	8431927040732
10047017	TUBO FLEXIBLE RB-PA DN17 NEGR	0104	1006	<b>10,455</b>	m	50	ROLLO	8431927040749
10047023	TUBO FLEXIBLE RB-PA DN23 NEGR	0104	1006	<b>14,863</b>	m	50	ROLLO	8431927040756
10047029	TUBO FLEXIBLE RB-PA DN29 NEGR	0104	1006	<b>18,828</b>	m	50	ROLLO	8431927040763
10047036	TUBO FLEXIBLE RB-PA DN36 NEGR	0104	1006	<b>24,246</b>	m	30	ROLLO	8431927022530
10047048	TUBO FLEXIBLE RB-PA DN48 NEGR	0104	1006	<b>34,443</b>	m	30	ROLLO	8431927022547
10047052	TUBO FLEXIBLE RB-PA DN52 NEGR	0104	1006	<b>50,872</b>	m	30	ROLLO	8431927022554
10047070	TUBO FLEXIBLE RB-PA DN70 NEGR	0104	1006	<b>92,041</b>	m	10	ROLLO	8431927022561

## TUBO FLEXIBLE RB-PU NEGRO (BAJO PEDIDO)



Ref.	Descripción	SERIE	GTV	€/m	Unidad Venta	Unidad Embala.	Embalaje	Código EAN
10048017	TUBO FLEXIBLE RB-PU DN17 NEGR	0104	1006	<b>14,966</b>	m	50	ROLLO	8431927022578
10048023	TUBO FLEXIBLE RB-PU DN23 NEGR	0104	1006	<b>15,635</b>	m	50	ROLLO	8431927022585
10048029	TUBO FLEXIBLE RB-PU DN29 NEGR	0104	1006	<b>21,414</b>	m	50	ROLLO	8431927022592
10048036	TUBO FLEXIBLE RB-PU DN36 NEGR	0104	1006	<b>30,076</b>	m	30	ROLLO	8431927022608
10048048	TUBO FLEXIBLE RB-PU DN48 NEGR	0104	1020	<b>39,037</b>	m	30	ROLLO	8431927022615
10048052	TUBO FLEXIBLE RB-PU DN52 NEGR	0104	1020	<b>52,242</b>	m	30	ROLLO	8431927022622
10048070	TUBO FLEXIBLE RB-PU DN70 NEGR	0104	1020	<b>93,699</b>	m	30	ROLLO	8431927022639

## PROTECTOR DE TUBO (BAJO PEDIDO)



Ref.	Descripción	SERIE	GTV	€/ud	Unidad Venta	Unidad Embala.	Embalaje	Código EAN
33100036	PROTECTOR TUBO DN36	0104	1108	<b>16,892</b>	ud	10	BOLSA	8431927025715
33100048	PROTECTOR TUBO DN48	0104	1108	<b>18,190</b>	ud	10	BOLSA	8431927025722
33100052	PROTECTOR TUBO DN52	0104	1108	<b>20,528</b>	ud	10	BOLSA	8431927025739
33100070	PROTECTOR TUBO DN70	0104	1108	<b>33,331</b>	ud	10	BOLSA	8431927025746

## SOPORTE MEDIO/FINAL DE TUBO (BAJO PEDIDO)



Ref.	Descripción	SERIE	GTV	€/ud	Unidad Venta	Unidad Embala.	Embalaje	Código EAN
33110036	SOPORTE MEDIO DN36	0104	1108	<b>8,005</b>	ud	10	BOLSA	8431927025753
33110048	SOPORTE MEDIO DN48	0104	1108	<b>8,044</b>	ud	10	BOLSA	8431927025760
33110052	SOPORTE MEDIO DN52	0104	1108	<b>8,083</b>	ud	10	BOLSA	8431927025777
33110070	SOPORTE MEDIO DN70	0104	1108	<b>11,572</b>	ud	10	BOLSA	8431927025784
33110170	SOPORTE FINAL DN70	0104	1108	<b>11,629</b>	ud	10	BOLSA	8431927025791

## ABRAZADERA (BAJO PEDIDO)



Ref.	Descripción	SERIE	GTV	€/ud	Unidad Venta	Unidad Embala.	Embalaje	Código EAN
33120052	ABRAZADERA DN52	0104	1108	<b>38,553</b>	ud	10	BOLSA	8431927025807
33120070	ABRAZADERA DN70	0104	1108	<b>33,905</b>	ud	10	BOLSA	8431927025814

## ABRAZADERA S (BAJO PEDIDO)



Ref.	Descripción	SERIE	GTV	€/ud	Unidad Venta	Unidad Embala.	Embalaje	Código EAN
33130070	ABRAZADERA S DN70	0104	1108	<b>16,810</b>	ud	10	BOLSA	8431927019080

# SISTEMA PEMSAFLEX SERIE MACROFLEX

## TUBO MACROFLEX GRIS (BAJO PEDIDO)

Ref.	Descripción	SERIE	GTV	€/m	Unidad Venta	Unidad Embala.	Embalaje	Código EAN
10060052	TUBO MACROFLEX DN52 GRIS	0104	1024	<b>19,024</b>	m	10	ROLLO	8431927019004
10060070	TUBO MACROFLEX DN70 GRIS	0104	1024	<b>36,503</b>	m	10	ROLLO	8431927000347
10060095	TUBO MACROFLEX DN90 GRIS	0104	1024	<b>46,700</b>	m	10	ROLLO	8431927000354

## TUBO MACROFLEX NEGRO (BAJO PEDIDO)

Ref.	Descripción	SERIE	GTV	€/m	Unidad Venta	Unidad Embala.	Embalaje	Código EAN
10060552	TUBO MACROFLEX DN52 NEGR	0104	1024	<b>25,650</b>	m	10	ROLLO	8431927019011
10060570	TUBO MACROFLEX DN70 NEGR	0104	1024	<b>40,320</b>	m	10	ROLLO	8431927000385
10060595	TUBO MACROFLEX DN90 NEGR	0104	1024	<b>50,180</b>	m	10	ROLLO	8431927000392

## RACOR RECTO GRIS (BAJO PEDIDO)

Ref.	Descripción	SERIE	GTV	€/ud	Unidad Venta	Unidad Embala.	Embalaje	Código EAN
33010052	RACOR RECTO DN52 GRIS	0104	1108	<b>13,380</b>	ud	1	UNIDAD	8431927019097
33010070	RACOR RECTO DN70 GRIS	0104	1108	<b>14,801</b>	ud	1	UNIDAD	8431927004000
33010095	RACOR RECTO DN95 GRIS	0104	1108	<b>18,025</b>	ud	1	UNIDAD	8431927004017

## RACOR RECTO NEGRO (BAJO PEDIDO)

Ref.	Descripción	SERIE	GTV	€/ud	Unidad Venta	Unidad Embala.	Embalaje	Código EAN
33050052	RACOR RECTO DN52 NEGR	0104	1108	<b>13,380</b>	ud	1	UNIDAD	8431927019103
33050070	RACOR RECTO DN70 NEGR	0104	1108	<b>14,801</b>	ud	1	UNIDAD	8431927004062
33050095	RACOR RECTO DN95 NEGR	0104	1108	<b>18,025</b>	ud	1	UNIDAD	8431927004079

## ANGULAR 90° GRIS (BAJO PEDIDO)

Ref.	Descripción	SERIE	GTV	€/ud	Unidad Venta	Unidad Embala.	Embalaje	Código EAN
33020070	ANGULAR 90° DN70 GRIS	0104	1108	<b>26,698</b>	ud	1	UNIDAD	8431927004024
33020095	ANGULAR 90° DN95 GRIS	0104	1108	<b>34,783</b>	ud	1	UNIDAD	8431927004031

## ANGULAR 90° NEGRO (BAJO PEDIDO)

Ref.	Descripción	SERIE	GTV	€/ud	Unidad Venta	Unidad Embala.	Embalaje	Código EAN
33060070	ANGULAR 90° DN70 NEGR	0104	1108	<b>26,698</b>	ud	1	UNIDAD	8431927025678
33060095	ANGULAR 90° DN95 NEGR	0104	1108	<b>34,783</b>	ud	1	UNIDAD	8431927025685

## ANGULAR 90° GIRATORIO GRIS (BAJO PEDIDO)

Ref.	Descripción	SERIE	GTV	€/ud	Unidad Venta	Unidad Embala.	Embalaje	Código EAN
33030070	ANGULAR 90° GIR DN70 GRIS	0104	1108	<b>43,641</b>	ud	1	UNIDAD	8431927004048
33030095	ANGULAR 90° GIR DN95 GRIS	0104	1108	<b>51,438</b>	ud	1	UNIDAD	8431927004055

## ANGULAR 90° GIRATORIO NEGRO (BAJO PEDIDO)

Ref.	Descripción	SERIE	GTV	€/ud	Unidad Venta	Unidad Embala.	Embalaje	Código EAN
33070070	ANGULAR 90° GIR DN70 NEGR	0104	1108	<b>43,641</b>	ud	1	UNIDAD	8431927025692
33070095	ANGULAR 90° GIR DN95 NEGR	0104	1108	<b>51,438</b>	ud	1	UNIDAD	8431927025708

## JUNTA DE ESTANQUEIDAD TIPO I (BAJO PEDIDO)

Ref.	Descripción	SERIE	GTV	€/ud	Unidad Venta	Unidad Embala.	Embalaje	Código EAN
33090070	JUNTA ESTANQUEIDAD I DN70	0104	1108	<b>2,493</b>	ud	1	UNIDAD	8431927004086
33090095	JUNTA ESTANQUEIDAD I DN95	0104	1108	<b>2,505</b>	ud	1	UNIDAD	8431927004093

## JUNTA DE ESTANQUEIDAD TIPO II (BAJO PEDIDO)

Ref.	Descripción	SERIE	GTV	€/ud	Unidad Venta	Unidad Embala.	Embalaje	Código EAN
33090170	JUNTA ESTANQUEIDAD II DN70	0104	1108	<b>2,524</b>	ud	1	UNIDAD	8431927004109
33090195	JUNTA ESTANQUEIDAD II DN95	0104	1108	<b>2,536</b>	ud	1	UNIDAD	8431927004116

## ABRAZADERA TIPO II

Ref.	Descripción	SERIE	GTV	€/ud	Unidad Venta	Unidad Embala.	Embalaje	Código EAN
33090270	ABRAZADERA II DN70	0104	1108	<b>6,901</b>	ud	1	UNIDAD	8431927004123
33090295	ABRAZADERA II DN95	0104	1108	<b>9,425</b>	ud	1	UNIDAD	8431927004130



# SISTEMA PEMSA-PRENSAESTOPAS Y ACCESORIOS

## PRENSAESTOPAS HEXADIN IP54

### PRENSAESTOPAS HEXADIN-P PG



Ref.	Descripción	SERIE	GTV	€/ud	Unidad Venta	Unidad Embala.	Embalaje	Código EAN
20010007	PRENSA HEXADIN-P PG 7 ( 3.5/6) GRIS	0105	1201	<b>0,469</b>	ud	50	BOLSA	8431927000750
20010009	PRENSA HEXADIN-P PG 9 ( 4.5/7) GRIS	0105	1201	<b>0,477</b>	ud	50	BOLSA	8431927000767
20010011	PRENSA HEXADIN-P PG11 ( 6/9) GRIS	0105	1201	<b>0,515</b>	ud	50	BOLSA	8431927000774
20010013	PRENSA HEXADIN-P PG13 ( 8/13) GRIS	0105	1201	<b>0,559</b>	ud	50	BOLSA	8431927000781
20010016	PRENSA HEXADIN-P PG16 (11/14) GRIS	0105	1201	<b>0,642</b>	ud	50	BOLSA	8431927000798
20010021	PRENSA HEXADIN-P PG21 (14/18) GRIS	0105	1201	<b>0,917</b>	ud	50	BOLSA	8431927000804
20010029	PRENSA HEXADIN-P PG29 (18/25) GRIS	0105	1201	<b>1,590</b>	ud	25	BOLSA	8431927000811
20010036	PRENSA HEXADIN-P PG36 (25/32) GRIS	0105	1201	<b>2,893</b>	ud	10	BOLSA	8431927000828

### PRENSAESTOPAS HEXADIN-P Métrica



Ref.	Descripción	SERIE	GTV	€/ud	Unidad Venta	Unidad Embala.	Embalaje	Código EAN
20011120	PRENSA HEXADIN-P M12 ( 3.5/6) GRIS	0105	1201	<b>1,138</b>	ud	50	BOLSA	8431927041746
20011160	PRENSA HEXADIN-P M16 ( 4.5/7) GRIS	0105	1201	<b>1,000</b>	ud	50	BOLSA	8431927041753
20011161	PRENSA HEXADIN-P M16 ( 6/9) GRIS	0105	1201	<b>1,167</b>	ud	50	BOLSA	8431927041760
20011200	PRENSA HEXADIN-P M20 ( 8/13) GRIS	0105	1202	<b>1,199</b>	ud	50	BOLSA	8431927041777
20011201	PRENSA HEXADIN-P M20 (11/14) GRIS	0105	1202	<b>1,199</b>	ud	50	BOLSA	8431927041784
20011250	PRENSA HEXADIN-P M25 (14/18) GRIS	0105	1202	<b>2,085</b>	ud	50	BOLSA	8431927041791

### PRENSAESTOPAS HEXADIN-PG



Ref.	Descripción	SERIE	GTV	€/ud	Unidad Venta	Unidad Embala.	Embalaje	Código EAN
20050007	PRENSA HEXADIN-M PG 7 ( 6/ 8)	0105	1202	<b>1,333</b>	ud	50	BOLSA	8431927000842
20050009	PRENSA HEXADIN-M PG 9 ( 4/10)	0105	1202	<b>1,575</b>	ud	50	BOLSA	8431927000859
20050011	PRENSA HEXADIN-M PG11 ( 6.5/12)	0105	1202	<b>1,872</b>	ud	50	BOLSA	8431927000866
20050013	PRENSA HEXADIN-M PG13 ( 6.5/13.5)	0105	1202	<b>2,158</b>	ud	50	BOLSA	8431927000873
20050016	PRENSA HEXADIN-M PG16 ( 6.5/16)	0105	1202	<b>2,711</b>	ud	50	BOLSA	8431927000880
20050021	PRENSA HEXADIN-M PG21 ( 9/20)	0105	1202	<b>3,535</b>	ud	25	BOLSA	8431927000897
20050029	PRENSA HEXADIN-M PG29 (17/28)	0105	1202	<b>6,147</b>	ud	25	BOLSA	8431927000903
20050036	PRENSA HEXADIN-M PG36 (23/34)	0105	1202	<b>13,245</b>	ud	10	BOLSA	8431927000910
20050048	PRENSA HEXADIN-M PG48 (35/46)	0105	1202	<b>24,970</b>	ud	5	BOLSA	8431927000927

### PRENSAESTOPAS HEXADIN-Métrica



Ref.	Descripción	SERIE	GTV	€/ud	Unidad Venta	Unidad Embala.	Embalaje	Código EAN
20051120	PRENSA HEXADIN-M M12 ( 5/ 7)	0105	1202	<b>1,434</b>	ud	50	BOLSA	8431927042668
20051160	PRENSA HEXADIN-M M16 ( 4/ 9.5)	0105	1202	<b>1,987</b>	ud	50	BOLSA	8431927042675
20051200	PRENSA HEXADIN-M M20 ( 6/13)	0105	1202	<b>2,820</b>	ud	50	BOLSA	8431927042682
20051250	PRENSA HEXADIN-M M25 ( 6/15)	0105	1202	<b>3,959</b>	ud	50	BOLSA	8431927042699
20051320	PRENSA HEXADIN-M M32 ( 9/20)	0105	1202	<b>6,270</b>	ud	25	BOLSA	8431927042705
20051400	PRENSA HEXADIN-M M40 (15/27)	0105	1202	<b>10,354</b>	ud	10	BOLSA	8431927042712
20051500	PRENSA HEXADIN-M M50 (21/33)	0105	1202	<b>20,119</b>	ud	5	BOLSA	8431927042729
20051630	PRENSA HEXADIN-M M63 (30/45)	0105	1202	<b>30,955</b>	ud	5	BOLSA	8431927042736

### PRENSAESTOPAS HEXADIN-M ROSCA LARGA PG



Ref.	Descripción	SERIE	GTV	€/ud	Unidad Venta	Unidad Embala.	Embalaje	Código EAN
20060007	PRENSA HEXADIN-M-L PG 7 ( 6/ 8)	0105	1201	<b>2,755</b>	ud	50	BOLSA	8431927019165
20060009	PRENSA HEXADIN-M-L PG 9 ( 4/10)	0105	1201	<b>2,398</b>	ud	50	BOLSA	8431927000934
20060011	PRENSA HEXADIN-M-L PG11 ( 6.5/12)	0105	1201	<b>2,750</b>	ud	50	BOLSA	8431927000941
20060013	PRENSA HEXADIN-M-L PG13 ( 6.5/13.5)	0105	1201	<b>3,139</b>	ud	50	BOLSA	8431927000958
20060016	PRENSA HEXADIN-M-L PG16 ( 6.5/16)	0105	1201	<b>4,015</b>	ud	50	BOLSA	8431927000965
20060021	PRENSA HEXADIN-M-L PG21 ( 9/20)	0105	1201	<b>5,355</b>	ud	25	BOLSA	8431927000972
20060029	PRENSA HEXADIN-M-L PG29 (17/28)	0105	1201	<b>9,255</b>	ud	25	BOLSA	8431927000989
20060036	PRENSA HEXADIN-M-L PG36 (23/34)	0105	1201	<b>14,955</b>	ud	10	BOLSA	8431927000996
20060048	PRENSA HEXADIN-M-L PG48 (35/46)	0105	1201	<b>33,620</b>	ud	5	BOLSA	8431927001009

# NUEVA GAMA DE PRENSAESTOPAS IRIS IP68

## PRENSAESTOPAS IRIS-P PG GRIS IP68



Ref.	Descripción	SERIE	GTV	€/ud	Unidad Venta	Unidad Embala.	Embalaje	Código EAN
21040007	PRENSA IRIS-P PG 7 ( 3/ 6,5) GRIS	0105	1202	<b>0,651</b>	ud	50	BOLSA	8431927041852
21040009	PRENSA IRIS-P PG 9 ( 4/ 8) GRIS	0105	1202	<b>0,688</b>	ud	50	BOLSA	8431927041869
21040011	PRENSA IRIS-P PG11 ( 5/10) GRIS	0105	1202	<b>0,728</b>	ud	50	BOLSA	8431927041876
21040013	PRENSA IRIS-P PG13 ( 6/12) GRIS	0105	1202	<b>0,821</b>	ud	50	BOLSA	8431927041883
21040016	PRENSA IRIS-P PG16 (10/14) GRIS	0105	1202	<b>0,945</b>	ud	50	BOLSA	8431927041890
21040021	PRENSA IRIS-P PG21 (13/18) GRIS	0105	1202	<b>1,419</b>	ud	50	BOLSA	8431927041906
21040029	PRENSA IRIS-P PG29 (18/25) GRIS	0105	1202	<b>2,772</b>	ud	25	BOLSA	8431927041913
21040036	PRENSA IRIS-P PG36 (22/32) GRIS	0105	1202	<b>6,025</b>	ud	10	BOLSA	8431927041920
21040042	PRENSA IRIS-P PG42 (30/38) GRIS	0105	1202	<b>9,849</b>	ud	5	BOLSA	8431927041937
21040048	PRENSA IRIS-P PG48 (34/44) GRIS	0105	1202	<b>10,244</b>	ud	5	BOLSA	8431927041944

## PRENSAESTOPAS IRIS-P Métrica GRIS IP68



Ref.	Descripción	SERIE	GTV	€/ud	Unidad Venta	Unidad Embala.	Embalaje	Código EAN
21041120	PRENSA IRIS-P M12 ( 3/ 6,5) GRIS	0105	1202	<b>0,673</b>	ud	50	BOLSA	8431927041951
21041160	PRENSA IRIS-P M16 ( 4/ 8) GRIS	0105	1202	<b>0,712</b>	ud	50	BOLSA	8431927041968
21041161	PRENSA IRIS-P M16 ( 5/10) GRIS	0105	1202	<b>0,712</b>	ud	50	BOLSA	8431927041975
21041200	PRENSA IRIS-P M20 ( 6/12) GRIS	0105	1202	<b>0,814</b>	ud	50	BOLSA	8431927041982
21041201	PRENSA IRIS-P M20 (10/14) GRIS	0105	1202	<b>0,890</b>	ud	50	BOLSA	8431927041999
21041250	PRENSA IRIS-P M25 (13/18) GRIS	0105	1202	<b>1,394</b>	ud	50	BOLSA	8431927042002
21041320	PRENSA IRIS-P M32 (18/25) GRIS	0105	1202	<b>2,799</b>	ud	25	BOLSA	8431927042019
21041400	PRENSA IRIS-P M40 (22/32) GRIS	0105	1202	<b>5,899</b>	ud	10	BOLSA	8431927042026
21041500	PRENSA IRIS-P M50 (32/38) GRIS	0105	1202	<b>9,285</b>	ud	5	BOLSA	8431927042033
21041630	PRENSA IRIS-P M63 (37/44) GRIS	0105	1202	<b>10,015</b>	ud	5	BOLSA	8431927042040

## PRENSAESTOPAS IRIS-P PG GRIS OSCURO IP68



Ref.	Descripción	SERIE	GTV	€/ud	Unidad Venta	Unidad Embala.	Embalaje	Código EAN
21060007	PRENSA IRIS-P PG 7 (3/6,5) GRIS OSCURO	0105	1202	<b>0,651</b>	ud	50	BOLSA	8431927044716
21060009	PRENSA IRIS-P PG 9 (4/8) GRIS OSCURO	0105	1202	<b>0,688</b>	ud	50	BOLSA	8431927044723
21060011	PRENSA IRIS-P PG11 (5/10) GRIS OSCURO	0105	1202	<b>0,728</b>	ud	50	BOLSA	8431927044730
21060013	PRENSA IRIS-P PG13 (6/12) GRIS OSCURO	0105	1202	<b>0,821</b>	ud	50	BOLSA	8431927044747
21060016	PRENSA IRIS-P PG16 (10/14) GRIS OSCURO	0105	1202	<b>0,945</b>	ud	50	BOLSA	8431927044754
21060021	PRENSA IRIS-P PG21 (13/18) GRIS OSCURO	0105	1202	<b>1,419</b>	ud	50	BOLSA	8431927044761
21060029	PRENSA IRIS-P PG29 (18/25) GRIS OSCURO	0105	1202	<b>2,772</b>	ud	25	BOLSA	8431927044778
21060036	PRENSA IRIS-P PG36 (22/32) GRIS OSCURO	0105	1202	<b>6,025</b>	ud	10	BOLSA	8431927044785
21060042	PRENSA IRIS-P PG42 (30/38) GRIS OSCURO	0105	1202	<b>9,849</b>	ud	5	BOLSA	8431927044792
21060048	PRENSA IRIS-P PG48 (34/44) GRIS OSCURO	0105	1202	<b>10,244</b>	ud	5	BOLSA	8431927044808

## PRENSAESTOPAS IRIS-P Métrica GRIS OSCURO IP68



Ref.	Descripción	SERIE	GTV	€/ud	Unidad Venta	Unidad Embala.	Embalaje	Código EAN
21061120	PRENSA IRIS-P M12 (3/6,5) GRIS OSCURO	0105	1202	<b>0,673</b>	ud	50	BOLSA	8431927044815
21061160	PRENSA IRIS-P M16 (4/8) GRIS OSCURO	0105	1202	<b>0,712</b>	ud	50	BOLSA	8431927044822
21061161	PRENSA IRIS-P M16 (5/10) GRIS OSCURO	0105	1202	<b>0,712</b>	ud	50	BOLSA	8431927044839
21061200	PRENSA IRIS-P M20 (6/12) GRIS OSCURO	0105	1202	<b>0,814</b>	ud	50	BOLSA	8431927044846
21061201	PRENSA IRIS-P M20 (10/14) GRIS OSCURO	0105	1202	<b>0,890</b>	ud	50	BOLSA	8431927044853
21061250	PRENSA IRIS-P M25 (13/18) GRIS OSCURO	0105	1202	<b>1,394</b>	ud	50	BOLSA	8431927044860
21061320	PRENSA IRIS-P M32 (18/25) GRIS OSCURO	0105	1202	<b>2,799</b>	ud	25	BOLSA	8431927044877
21061400	PRENSA IRIS-P M40 (22/32) GRIS OSCURO	0105	1202	<b>5,899</b>	ud	10	BOLSA	8431927044884
21061500	PRENSA IRIS-P M50 (32/38) GRIS OSCURO	0105	1202	<b>9,285</b>	ud	5	BOLSA	8431927044891
21061630	PRENSA IRIS-P M63 (37/44) GRIS OSCURO	0105	1202	<b>10,015</b>	ud	5	BOLSA	8431927044907

## PRENSAESTOPAS IRIS-P PG NEGRO IP68



Ref.	Descripción	SERIE	GTV	€/ud	Unidad Venta	Unidad Embala.	Embalaje	Código EAN
21050007	PRENSA IRIS-P PG 7 ( 3/ 6,5) NEGR	0105	1202	<b>0,651</b>	ud	50	BOLSA	8431927042057
21050009	PRENSA IRIS-P PG 9 ( 4/ 8) NEGR	0105	1202	<b>0,688</b>	ud	50	BOLSA	8431927042064
21050011	PRENSA IRIS-P PG11 ( 5/10) NEGR	0105	1202	<b>0,728</b>	ud	50	BOLSA	8431927042071
21050013	PRENSA IRIS-P PG13 ( 6/12) NEGR	0105	1202	<b>0,821</b>	ud	50	BOLSA	8431927042088
21050016	PRENSA IRIS-P PG16 (10/14) NEGR	0105	1202	<b>0,945</b>	ud	50	BOLSA	8431927042095
21050021	PRENSA IRIS-P PG21 (13/18) NEGR	0105	1202	<b>1,419</b>	ud	50	BOLSA	8431927042101
21050029	PRENSA IRIS-P PG29 (18/25) NEGR	0105	1202	<b>2,825</b>	ud	25	BOLSA	8431927042118
21050036	PRENSA IRIS-P PG36 (22/32) NEGR	0105	1202	<b>6,025</b>	ud	10	BOLSA	8431927042125
21050042	PRENSA IRIS-P PG42 (30/38) NEGR	0105	1202	<b>9,849</b>	ud	5	BOLSA	8431927042132
21050048	PRENSA IRIS-P PG48 (34/44) NEGR	0105	1202	<b>10,244</b>	ud	5	BOLSA	8431927042149

**PRENSAESTOPAS IRIS-P Métrica NEGRO IP68**



Ref.	Descripción	SERIE	GTV	€/ud	Unidad Venta	Unidad Embala.	Embalaje	Código EAN
21051120	PRENSA IRIS-P M12 ( 3/ 6,5) NEGR	0105	1202	<b>0,673</b>	ud	50	BOLSA	8431927042156
21051160	PRENSA IRIS-P M16 ( 4/ 8) NEGR	0105	1202	<b>0,712</b>	ud	50	BOLSA	8431927042163
21051161	PRENSA IRIS-P M16 ( 5/10) NEGR	0105	1202	<b>0,712</b>	ud	50	BOLSA	8431927042170
21051200	PRENSA IRIS-P M20 ( 6/12) NEGR	0105	1202	<b>0,814</b>	ud	50	BOLSA	8431927042187
21051201	PRENSA IRIS-P M20 (10/14) NEGR	0105	1202	<b>0,890</b>	ud	50	BOLSA	8431927042194
21051250	PRENSA IRIS-P M25 (13/18) NEGR	0105	1202	<b>1,394</b>	ud	50	BOLSA	8431927042200
21051320	PRENSA IRIS-P M32 (18/25) NEGR	0105	1202	<b>2,799</b>	ud	25	BOLSA	8431927042217
21051400	PRENSA IRIS-P M40 (22/32) NEGR	0105	1202	<b>5,899</b>	ud	10	BOLSA	8431927042224
21051500	PRENSA IRIS-P M50 (32/38) NEGR	0105	1202	<b>9,285</b>	ud	5	BOLSA	8431927042231
21051630	PRENSA IRIS-P M63 (37/44) NEGR	0105	1202	<b>10,015</b>	ud	5	BOLSA	8431927042248

**PRENSAESTOPAS IRIS-P ROSCA LARGA PG GRIS**



Ref.	Descripción	SERIE	GTV	€/ud	Unidad Venta	Unidad Embala.	Embalaje	Código EAN
21044007	PRENSA IRIS-P L PG 7 ( 3/ 6.5) GRIS	0105	1202	<b>0,924</b>	ud	100	BOLSA	8431927098016
21044009	PRENSA IRIS-P L PG 9 ( 4/ 8) GRIS	0105	1202	<b>1,003</b>	ud	100	BOLSA	8431927098023
21044011	PRENSA IRIS-P L PG11 ( 5/10) GRIS	0105	1202	<b>1,078</b>	ud	100	BOLSA	8431927098030
21044013	PRENSA IRIS-P L PG13 ( 6/12) GRIS	0105	1202	<b>1,192</b>	ud	100	BOLSA	8431927098047
21044016	PRENSA IRIS-P L PG16 (10/14) GRIS	0105	1202	<b>1,409</b>	ud	100	BOLSA	8431927098054
21044021	PRENSA IRIS-P L PG21 (13/18) GRIS	0105	1202	<b>2,098</b>	ud	50	BOLSA	8431927098061

**PRENSAESTOPAS IRIS-P ROSCA LARGA Métrica**



Ref.	Descripción	SERIE	GTV	€/ud	Unidad Venta	Unidad Embala.	Embalaje	Código EAN
21045120	PRENSA IRIS-P L M12 ( 3/ 6.5) GRIS	0105	1202	<b>0,964</b>	ud	100	BOLSA	8431927098078
21045160	PRENSA IRIS-P L M16 ( 4/ 8) GRIS	0105	1202	<b>0,944</b>	ud	100	BOLSA	8431927098085
21045161	PRENSA IRIS-P L M16 ( 5/10) GRIS	0105	1202	<b>1,042</b>	ud	100	BOLSA	8431927098092
21045200	PRENSA IRIS-P L M20 ( 6/12) GRIS	0105	1202	<b>1,225</b>	ud	100	BOLSA	8431927098108
21045201	PRENSA IRIS-P L M20 (10/14) GRIS	0105	1202	<b>1,348</b>	ud	100	BOLSA	8431927098115
21045250	PRENSA IRIS-P L M25 (13/18) GRIS	0105	1202	<b>2,105</b>	ud	50	BOLSA	8431927098122
21045320	PRENSA IRIS-P L M32 (18/25) GRIS	0105	1202	<b>4,145</b>	ud	25	BOLSA	8431927098139
21045400	PRENSA IRIS-P L M40 (22/32) GRIS	0105	1202	<b>10,154</b>	ud	10	BOLSA	8431927098146

**PRENSAESTOPAS IRIS-P FLEX GRIS PG**



Ref.	Descripción	SERIE	GTV	€/ud	Unidad Venta	Unidad Embala.	Embalaje	Código EAN
21046007	PRENSA IRIS-P FLEX PG 7 ( 3/6.5) GRIS	0105	1202	<b>0,864</b>	ud	100	BOLSA	8431927098153
21046009	PRENSA IRIS-P FLEX PG 9 ( 4/8) GRIS	0105	1202	<b>1,025</b>	ud	100	BOLSA	8431927098160
21046011	PRENSA IRIS-P FLEX PG11 ( 5/10) GRIS	0105	1202	<b>1,222</b>	ud	100	BOLSA	8431927098177
21046013	PRENSA IRIS-P FLEX PG13 ( 6/12) GRIS	0105	1202	<b>1,370</b>	ud	100	BOLSA	8431927098184
21046016	PRENSA IRIS-P FLEX PG16 (10/14) GRIS	0105	1202	<b>1,937</b>	ud	100	BOLSA	8431927098191
21046021	PRENSA IRIS-P FLEX PG21 (13/18) GRIS	0105	1202	<b>2,545</b>	ud	50	BOLSA	8431927098207

**PRENSAESTOPAS IRIS-P FLEX GRIS Métrica**



Ref.	Descripción	SERIE	GTV	€/ud	Unidad Venta	Unidad Embala.	Embalaje	Código EAN
21047120	PRENSA IRIS-P FLEX M12 ( 3/6.5) GRIS	0105	1202	<b>1,147</b>	ud	100	BOLSA	8431927098214
21047160	PRENSA IRIS-P FLEX M16 ( 4/8) GRIS	0105	1202	<b>1,372</b>	ud	100	BOLSA	8431927098221
21047161	PRENSA IRIS-P FLEX M16 ( 5/10) GRIS	0105	1202	<b>1,372</b>	ud	100	BOLSA	8431927098238
21047200	PRENSA IRIS-P FLEX M20 ( 6/12) GRIS	0105	1202	<b>1,545</b>	ud	100	BOLSA	8431927098245
21047201	PRENSA IRIS-P FLEX M20 (10/14) GRIS	0105	1202	<b>1,545</b>	ud	100	BOLSA	8431927098252
21047250	PRENSA IRIS-P FLEX M25 (13/18) GRIS	0105	1202	<b>2,845</b>	ud	50	BOLSA	8431927098269

**PRENSAESTOPAS IRIS-P FLEX NEGRO PG**



Ref.	Descripción	SERIE	GTV	€/ud	Unidad Venta	Unidad Embala.	Embalaje	Código EAN
21056007	PRENSA IRIS-P FLEX PG 7 ( 3/6.5) NEGRO	0105	1202	<b>0,842</b>	ud	100	BOLSA	8431927098399
21056009	PRENSA IRIS-P FLEX PG 9 ( 4/8) NEGRO	0105	1202	<b>0,975</b>	ud	100	BOLSA	8431927098405
21056011	PRENSA IRIS-P FLEX PG11 ( 5/10) NEGRO	0105	1202	<b>1,129</b>	ud	100	BOLSA	8431927098412
21056013	PRENSA IRIS-P FLEX PG13 ( 6/12) NEGRO	0105	1202	<b>1,231</b>	ud	100	BOLSA	8431927098429
21056016	PRENSA IRIS-P FLEX PG16 (10/14) NEGRO	0105	1202	<b>1,529</b>	ud	100	BOLSA	8431927098436
21056021	PRENSA IRIS-P FLEX PG21 (13/18) NEGRO	0105	1202	<b>2,381</b>	ud	50	BOLSA	8431927098443

**PRENSAESTOPAS IRIS-P FLEX NEGRO Métrica**



Ref.	Descripción	SERIE	GTV	€/ud	Unidad Venta	Unidad Embala.	Embalaje	Código EAN
21057120	PRENSA IRIS-P FLEX M12 ( 3/6.5) NEGRO	0105	1202	<b>0,924</b>	ud	100	BOLSA	8431927098450
21057160	PRENSA IRIS-P FLEX M16 ( 4/8) NEGRO	0105	1202	<b>1,073</b>	ud	100	BOLSA	8431927098467
21057161	PRENSA IRIS-P FLEX M16 ( 5/10) NEGRO	0105	1202	<b>1,242</b>	ud	100	BOLSA	8431927098474
21057200	PRENSA IRIS-P FLEX M20 ( 6/12) NEGRO	0105	1202	<b>1,354</b>	ud	100	BOLSA	8431927098481
21057201	PRENSA IRIS-P FLEX M20 (10/14) NEGRO	0105	1202	<b>1,760</b>	ud	100	BOLSA	8431927098498
21057250	PRENSA IRIS-P FLEX M25 (13/18) NEGRO	0105	1202	<b>2,719</b>	ud	50	BOLSA	8431927098504

**PRENSAESTOPAS IRIS-P FLEX ROSCA LARGA GRIS PG**



Ref.	Descripción	SERIE	GTV	€/ud	Unidad Venta	Unidad Embala.	Embalaje	Código EAN
21048007	IRIS-P FLEX-L PG 7 ( 3/ 6.5) GRIS	0105	1202	<b>0,928</b>	ud	100	BOLSA	8431927098276
21048009	IRIS-P FLEX-L PG 9 ( 4/ 8) GRIS	0105	1202	<b>1,073</b>	ud	100	BOLSA	8431927098283
21048011	IRIS-P FLEX-L PG11 ( 5/10) GRIS	0105	1202	<b>1,241</b>	ud	100	BOLSA	8431927098290
21048013	IRIS-P FLEX-L PG13 ( 6/12) GRIS	0105	1202	<b>1,354</b>	ud	100	BOLSA	8431927098306
21048016	IRIS-P FLEX-L PG16 (10/14) GRIS	0105	1202	<b>1,682</b>	ud	100	BOLSA	8431927098313
21048021	IRIS-P FLEX-L PG21 (13/18) GRIS	0105	1202	<b>2,618</b>	ud	50	BOLSA	8431927098320

**PRENSAESTOPAS IRIS-P FLEX ROSCA LARGA GRIS Métrica**



Ref.	Descripción	SERIE	GTV	€/ud	Unidad Venta	Unidad Embala.	Embalaje	Código EAN
21049120	IRIS-P FLEX-L M12 ( 3/ 6.5) GRIS	0105	1202	<b>1,025</b>	ud	100	BOLSA	8431927098337
21049160	IRIS-P FLEX-L M16 ( 4/ 8) GRIS	0105	1202	<b>1,191</b>	ud	100	BOLSA	8431927098344
21049161	IRIS-P FLEX-L M16 ( 5/10) GRIS	0105	1202	<b>1,380</b>	ud	100	BOLSA	8431927098351
21049200	IRIS-P FLEX-L M20 ( 6/12) GRIS	0105	1202	<b>1,488</b>	ud	100	BOLSA	8431927098368
21049201	IRIS-P FLEX-L M20 (10/14) GRIS	0105	1202	<b>1,940</b>	ud	100	BOLSA	8431927098375
21049250	IRIS-P FLEX-L M25 (13/18) GRIS	0105	1202	<b>2,925</b>	ud	50	BOLSA	8431927098382

**PRENSAESTOPAS IRIS-P FLEX ROSCA LARGA NEGRO PG**



Ref.	Descripción	SERIE	GTV	€/ud	Unidad Venta	Unidad Embala.	Embalaje	Código EAN
21058007	IRIS-P FLEX-L PG 7 ( 3/ 6.5) NEGR	0105	1202	<b>0,928</b>	ud	100	BOLSA	8431927098511
21058009	IRIS-P FLEX-L PG 9 ( 4/ 8) NEGR	0105	1202	<b>1,073</b>	ud	100	BOLSA	8431927098528
21058011	IRIS-P FLEX-L PG11 ( 5/10) NEGR	0105	1202	<b>1,241</b>	ud	100	BOLSA	8431927098535
21058013	IRIS-P FLEX-L PG13 ( 6/12) NEGR	0105	1202	<b>1,354</b>	ud	100	BOLSA	8431927098542
21058016	IRIS-P FLEX-L PG16 (10/14) NEGR	0105	1202	<b>1,682</b>	ud	100	BOLSA	8431927098559
21058021	IRIS-P FLEX-L PG21 (13/18) NEGR	0105	1202	<b>2,618</b>	ud	50	BOLSA	8431927098566

**PRENSAESTOPAS IRIS-P FLEX ROSCA LARGA NEGRO Métrica**



Ref.	Descripción	SERIE	GTV	€/ud	Unidad Venta	Unidad Embala.	Embalaje	Código EAN
21059120	IRIS-P FLEX-L M12 ( 3/ 6.5) NEGR	0105	1202	<b>1,025</b>	ud	100	BOLSA	8431927098573
21059160	IRIS-P FLEX-L M16 ( 4/ 8) NEGR	0105	1202	<b>1,191</b>	ud	100	BOLSA	8431927098580
21059161	IRIS-P FLEX-L M16 ( 5/10) NEGR	0105	1202	<b>1,380</b>	ud	100	BOLSA	8431927098597
21059200	IRIS-P FLEX-L M20 ( 6/12) NEGR	0105	1202	<b>1,488</b>	ud	100	BOLSA	8431927098603
21059201	IRIS-P FLEX-L M20 (10/14) NEGR	0105	1202	<b>1,940</b>	ud	100	BOLSA	8431927098610
21059250	IRIS-P FLEX-L M25 (13/18) NEGR	0105	1202	<b>2,925</b>	ud	50	BOLSA	8431927098627

**PRENSAESTOPAS IRIS Plástico INSERTO CABLE PLANO PG IP65**



Ref.	Descripción	SERIE	GTV	€/ud	Unidad Venta	Unidad Embala.	Embalaje	Código EAN
21140016	PRENSA IRIS-P IP PG16 ( 7x13) GRIS	0105	1202	<b>0,683</b>	ud	50	BOLSA	Consultar
21140021	PRENSA IRIS-P IP PG21 ( 7x15) GRIS	0105	1202	<b>1,026</b>	ud	50	BOLSA	Consultar
21140029	PRENSA IRIS-P IP PG29 ( 8x22) GRIS	0105	1202	<b>2,189</b>	ud	25	BOLSA	Consultar
21140036	PRENSA IRIS-P IP PG36 (10x28) GRIS	0105	1202	<b>5,531</b>	ud	10	BOLSA	Consultar
21140042	PRENSA IRIS-P IP PG42 (12x33) GRIS	0105	1202	<b>9,402</b>	ud	5	BOLSA	Consultar
21140048	PRENSA IRIS-P IP PG48 (14x45) GRIS	0105	1202	<b>9,825</b>	ud	5	BOLSA	Consultar
21150016	PRENSA IRIS-P IP PG16 ( 7x13) NEGRO	0105	1202	<b>0,683</b>	ud	50	BOLSA	Consultar
21150021	PRENSA IRIS-P IP PG21 ( 7x15) NEGRO	0105	1202	<b>1,026</b>	ud	50	BOLSA	Consultar
21150029	PRENSA IRIS-P IP PG29 ( 8x22) NEGRO	0105	1202	<b>2,189</b>	ud	25	BOLSA	Consultar
21150036	PRENSA IRIS-P IP PG36 (10x28) NEGRO	0105	1202	<b>5,392</b>	ud	10	BOLSA	Consultar
21150042	PRENSA IRIS-P IP PG42 (12x33) NEGRO	0105	1202	<b>9,168</b>	ud	5	BOLSA	Consultar
21150048	PRENSA IRIS-P IP PG48 (14x45) NEGRO	0105	1202	<b>9,825</b>	ud	5	BOLSA	Consultar
21160016	PRENSA IRIS-P IP PG16 ( 7x13) GRIS O	0105	1202	<b>0,683</b>	ud	50	BOLSA	Consultar
21160021	PRENSA IRIS-P IP PG21 ( 7x15) GRIS O	0105	1202	<b>1,026</b>	ud	50	BOLSA	Consultar
21160029	PRENSA IRIS-P IP PG29 ( 8x22) GRIS O	0105	1202	<b>2,189</b>	ud	25	BOLSA	Consultar
21160036	PRENSA IRIS-P IP PG36 (10x28) GRIS O	0105	1202	<b>5,531</b>	ud	10	BOLSA	Consultar
21160042	PRENSA IRIS-P IP PG42 (12x33) GRIS O	0105	1202	<b>9,168</b>	ud	5	BOLSA	Consultar
21160048	PRENSA IRIS-P IP PG48 (14x45) GRIS O	0105	1202	<b>9,825</b>	ud	5	BOLSA	Consultar

**PRENSAESTOPAS IRIS Plástico INSERTO CABLE PLANO Métrica IP65**



Ref.	Descripción	SERIE	GTV	€/ud	Unidad Venta	Unidad Embala.	Embalaje	Código EAN
21141201	PRENSA IRIS-P IP M20 ( 7x13) GRIS	0105	1202	<b>0,900</b>	ud	50	BOLSA	Consultar
21141250	PRENSA IRIS-P IP M25 ( 7x15) GRIS	0105	1202	<b>1,062</b>	ud	50	BOLSA	Consultar
21141320	PRENSA IRIS-P IP M32 ( 8x22) GRIS	0105	1202	<b>2,189</b>	ud	25	BOLSA	Consultar
21141400	PRENSA IRIS-P IP M40 (10x28) GRIS	0105	1202	<b>5,093</b>	ud	10	BOLSA	Consultar
21141500	PRENSA IRIS-P IP M50 (12x33) GRIS	0105	1202	<b>8,156</b>	ud	5	BOLSA	Consultar
21141630	PRENSA IRIS-P IP M63 (14x45) GRIS	0105	1202	<b>8,905</b>	ud	5	BOLSA	Consultar
21151201	PRENSA IRIS-P IP M20 ( 7x13) NEGRO	0105	1202	<b>0,900</b>	ud	50	BOLSA	Consultar
21151250	PRENSA IRIS-P IP M25 ( 7x15) NEGRO	0105	1202	<b>1,062</b>	ud	50	BOLSA	Consultar
21151320	PRENSA IRIS-P IP M32 ( 8x22) NEGRO	0105	1202	<b>2,189</b>	ud	25	BOLSA	Consultar
21151400	PRENSA IRIS-P IP M40 (10x28) NEGRO	0105	1202	<b>5,224</b>	ud	10	BOLSA	Consultar
21151500	PRENSA IRIS-P IP M50 (12x33) NEGRO	0105	1202	<b>8,364</b>	ud	5	BOLSA	Consultar
21151630	PRENSA IRIS-P IP M63 (14x45) NEGRO	0105	1202	<b>9,130</b>	ud	5	BOLSA	Consultar
21161201	PRENSA IRIS-P IP M20 ( 7x13) GRIS O	0105	1202	<b>0,900</b>	ud	50	BOLSA	Consultar
21161250	PRENSA IRIS-P IP M25 ( 7x15) GRIS O	0105	1202	<b>1,062</b>	ud	50	BOLSA	Consultar
21161320	PRENSA IRIS-P IP M32 ( 8x22) GRIS O	0105	1202	<b>2,189</b>	ud	25	BOLSA	Consultar
21161400	PRENSA IRIS-P IP M40 (10x28) GRIS O	0105	1202	<b>5,224</b>	ud	10	BOLSA	Consultar
21161500	PRENSA IRIS-P IP M50 (12x33) GRIS O	0105	1202	<b>8,364</b>	ud	5	BOLSA	Consultar
21161630	PRENSA IRIS-P IP M63 (14x45) GRIS O	0105	1202	<b>9,130</b>	ud	5	BOLSA	Consultar

**PRENSAESTOPAS IRIS Plástico INSERTO MULTICABLE PG IP65**



Ref.	Descripción	SERIE	GTV	€/ud	Unidad Venta	Unidad Embala.	Embalaje	Código EAN
21240009	PRENSA IRIS-P IMC PG 9 ( 2x 3) GRIS	0105	1202	<b>1,217</b>	ud	50	BOLSA	Consultar
21240011	PRENSA IRIS-P IMC PG11 ( 2x 4) GRIS	0105	1202	<b>1,441</b>	ud	50	BOLSA	Consultar
21250009	PRENSA IRIS-P IMC PG 9 ( 2x 3) NEGRO	0105	1202	<b>1,217</b>	ud	50	BOLSA	Consultar
21250011	PRENSA IRIS-P IMC PG11 ( 2x 4) NEGRO	0105	1202	<b>1,476</b>	ud	50	BOLSA	Consultar
21260009	PRENSA IRIS-P IMC PG 9 ( 2x 3) GRIS O	0105	1202	<b>1,217</b>	ud	50	BOLSA	Consultar
21260011	PRENSA IRIS-P IMC PG11 ( 2x 4) GRIS O	0105	1202	<b>1,432</b>	ud	50	BOLSA	Consultar
21340011	PRENSA IRIS-P IMC PG11 ( 2x 5) GRIS	0105	1202	<b>1,441</b>	ud	50	BOLSA	Consultar
21340013	PRENSA IRIS-P IMC PG13 ( 2x 6) GRIS	0105	1202	<b>1,624</b>	ud	50	BOLSA	Consultar
21340016	PRENSA IRIS-P IMC PG16 ( 2x 7) GRIS	0105	1202	<b>1,739</b>	ud	50	BOLSA	Consultar
21340021	PRENSA IRIS-P IMC PG21 ( 2x 9) GRIS	0105	1202	<b>2,344</b>	ud	50	BOLSA	Consultar
21350011	PRENSA IRIS-P IMC PG11 ( 2x 5) NEGRO	0105	1202	<b>1,476</b>	ud	50	BOLSA	Consultar
21350013	PRENSA IRIS-P IMC PG13 ( 2x 6) NEGRO	0105	1202	<b>1,624</b>	ud	50	BOLSA	Consultar
21350016	PRENSA IRIS-P IMC PG16 ( 2x 7) NEGRO	0105	1202	<b>1,739</b>	ud	50	BOLSA	Consultar
21350021	PRENSA IRIS-P IMC PG21 ( 2x 9) NEGRO	0105	1202	<b>2,344</b>	ud	50	BOLSA	Consultar
21360011	PRENSA IRIS-P IMC PG11 ( 2x 5) GRIS O	0105	1202	<b>1,432</b>	ud	50	BOLSA	Consultar
21360013	PRENSA IRIS-P IMC PG13 ( 2x 6) GRIS O	0105	1202	<b>1,624</b>	ud	50	BOLSA	Consultar
21360016	PRENSA IRIS-P IMC PG16 ( 2x 7) GRIS O	0105	1202	<b>1,739</b>	ud	50	BOLSA	Consultar
21360021	PRENSA IRIS-P IMC PG21 ( 2x 9) GRIS O	0105	1202	<b>2,344</b>	ud	50	BOLSA	Consultar
21440009	PRENSA IRIS-P IMC PG 9 ( 3x 3) GRIS	0105	1202	<b>1,217</b>	ud	50	BOLSA	Consultar
21440021	PRENSA IRIS-P IMC PG21 ( 3x 7) GRIS	0105	1202	<b>2,344</b>	ud	50	BOLSA	Consultar
21440029	PRENSA IRIS-P IMC PG29 ( 4x 9) GRIS	0105	1202	<b>4,445</b>	ud	25	BOLSA	Consultar
21450009	PRENSA IRIS-P IMC PG 9 ( 3x 3) NEGRO	0105	1202	<b>1,217</b>	ud	50	BOLSA	Consultar
21450021	PRENSA IRIS-P IMC PG21 ( 3x 7) NEGRO	0105	1202	<b>2,344</b>	ud	50	BOLSA	Consultar
21450029	PRENSA IRIS-P IMC PG29 ( 4x 9) NEGRO	0105	1202	<b>4,445</b>	ud	25	BOLSA	Consultar
21460009	PRENSA IRIS-P IMC PG 9 ( 3x 3) GRIS O	0105	1202	<b>1,217</b>	ud	50	BOLSA	Consultar
21460021	PRENSA IRIS-P IMC PG21 ( 3x 7) GRIS O	0105	1202	<b>2,344</b>	ud	50	BOLSA	Consultar
21460029	PRENSA IRIS-P IMC PG29 ( 4x 9) GRIS O	0105	1202	<b>4,445</b>	ud	25	BOLSA	Consultar
21540011	PRENSA IRIS-P IMC PG11 ( 3x 5) GRIS	0105	1202	<b>1,441</b>	ud	50	BOLSA	Consultar
21540013	PRENSA IRIS-P IMC PG13 ( 3x 5) GRIS	0105	1202	<b>1,624</b>	ud	50	BOLSA	Consultar
21540016	PRENSA IRIS-P IMC PG16 ( 3x 6) GRIS	0105	1202	<b>1,739</b>	ud	50	BOLSA	Consultar
21540021	PRENSA IRIS-P IMC PG21 ( 3x 8) GRIS	0105	1202	<b>2,344</b>	ud	50	BOLSA	Consultar
21550011	PRENSA IRIS-P IMC PG11 ( 3x 5) NEGRO	0105	1202	<b>1,476</b>	ud	50	BOLSA	Consultar
21550013	PRENSA IRIS-P IMC PG13 ( 3x 5) NEGRO	0105	1202	<b>1,624</b>	ud	50	BOLSA	Consultar
21550016	PRENSA IRIS-P IMC PG16 ( 3x 6) NEGRO	0105	1202	<b>1,739</b>	ud	50	BOLSA	Consultar
21550021	PRENSA IRIS-P IMC PG21 ( 3x 8) NEGRO	0105	1202	<b>2,344</b>	ud	50	BOLSA	Consultar
21560011	PRENSA IRIS-P IMC PG11 ( 3x 5) GRIS O	0105	1202	<b>1,432</b>	ud	50	BOLSA	Consultar
21560013	PRENSA IRIS-P IMC PG13 ( 3x 5) GRIS O	0105	1202	<b>1,624</b>	ud	50	BOLSA	Consultar
21560016	PRENSA IRIS-P IMC PG16 ( 3x 6) GRIS O	0105	1202	<b>1,739</b>	ud	50	BOLSA	Consultar
21560021	PRENSA IRIS-P IMC PG21 ( 3x 8) GRIS O	0105	1202	<b>2,344</b>	ud	50	BOLSA	Consultar
21640009	PRENSA IRIS-P IMC PG 9 ( 4x 3) GRIS	0105	1202	<b>1,217</b>	ud	50	BOLSA	Consultar
21640016	PRENSA IRIS-P IMC PG16 ( 4x 5) GRIS	0105	1202	<b>1,739</b>	ud	50	BOLSA	Consultar
21640021	PRENSA IRIS-P IMC PG21 ( 4x 7) GRIS	0105	1202	<b>2,344</b>	ud	50	BOLSA	Consultar
21650009	PRENSA IRIS-P IMC PG 9 ( 4x 3) NEGRO	0105	1202	<b>1,217</b>	ud	50	BOLSA	Consultar
21650016	PRENSA IRIS-P IMC PG16 ( 4x 5) NEGRO	0105	1202	<b>1,739</b>	ud	50	BOLSA	Consultar
21650021	PRENSA IRIS-P IMC PG21 ( 4x 7) NEGRO	0105	1202	<b>2,344</b>	ud	50	BOLSA	Consultar
21660009	PRENSA IRIS-P IMC PG 9 ( 4x 3) GRIS O	0105	1202	<b>1,217</b>	ud	50	BOLSA	Consultar
21660016	PRENSA IRIS-P IMC PG16 ( 4x 5) GRIS O	0105	1202	<b>1,739</b>	ud	50	BOLSA	Consultar
21660021	PRENSA IRIS-P IMC PG21 ( 4x 7) GRIS O	0105	1202	<b>2,344</b>	ud	50	BOLSA	Consultar
21840021	PRENSA IRIS-P IMC PG21 ( 8x 4) GRIS	0105	1202	<b>2,344</b>	ud	50	BOLSA	Consultar
21840029	PRENSA IRIS-P IMC PG29 (16x 3) GRIS	0105	1202	<b>4,445</b>	ud	25	BOLSA	Consultar
21850021	PRENSA IRIS-P IMC PG21 ( 8x 4) NEGRO	0105	1202	<b>2,344</b>	ud	50	BOLSA	Consultar
21850029	PRENSA IRIS-P IMC PG29 (16x 3) NEGRO	0105	1202	<b>4,445</b>	ud	25	BOLSA	Consultar
21860021	PRENSA IRIS-P IMC PG21 ( 8x 4) GRIS O	0105	1202	<b>2,344</b>	ud	50	BOLSA	Consultar
21860029	PRENSA IRIS-P IMC PG29 (16x 3) GRIS O	0105	1202	<b>4,445</b>	ud	25	BOLSA	Consultar

**PRENSAESTOPAS IRIS Plástico INSERTO MULTICABLE Métrica IP65**



Ref.	Descripción	SERIE	GTV	€/ud	Unidad Venta	Unidad Embala.	Embalaje	Código EAN
21241160	PRENSA IRIS-P IMC M16 ( 2x 3) GRIS	0105	1202	<b>1,276</b>	ud	50	BOLSA	Consultar
21241161	PRENSA IRIS-P IMC M16 ( 2x 4) GRIS	0105	1202	<b>1,545</b>	ud	50	BOLSA	Consultar
21251160	PRENSA IRIS-P IMC M16 ( 2x 3) NEGRO	0105	1202	<b>1,276</b>	ud	50	BOLSA	Consultar
21251161	PRENSA IRIS-P IMC M16 ( 2x 4) NEGRO	0105	1202	<b>1,545</b>	ud	50	BOLSA	Consultar
21261160	PRENSA IRIS-P IMC M16 ( 2x 3) GRIS O	0105	1202	<b>1,276</b>	ud	50	BOLSA	Consultar
21261161	PRENSA IRIS-P IMC M16 ( 2x 4) GRIS O	0105	1202	<b>1,562</b>	ud	50	BOLSA	Consultar
21341161	PRENSA IRIS-P IMC M16 ( 2x 5) GRIS	0105	1202	<b>1,545</b>	ud	50	BOLSA	Consultar
21341200	PRENSA IRIS-P IMC M20 ( 2x 6) GRIS	0105	1202	<b>1,683</b>	ud	50	BOLSA	Consultar
21341201	PRENSA IRIS-P IMC M20 ( 2x 7) GRIS	0105	1202	<b>1,957</b>	ud	50	BOLSA	Consultar
21341250	PRENSA IRIS-P IMC M25 ( 2x 9) GRIS	0105	1202	<b>2,379</b>	ud	50	BOLSA	Consultar
21351161	PRENSA IRIS-P IMC M16 ( 2x 5) NEGRO	0105	1202	<b>1,545</b>	ud	50	BOLSA	Consultar
21351200	PRENSA IRIS-P IMC M20 ( 2x 6) NEGRO	0105	1202	<b>1,683</b>	ud	50	BOLSA	Consultar
21351201	PRENSA IRIS-P IMC M20 ( 2x 7) NEGRO	0105	1202	<b>1,957</b>	ud	50	BOLSA	Consultar
21351250	PRENSA IRIS-P IMC M25 ( 2x 9) NEGRO	0105	1202	<b>2,379</b>	ud	50	BOLSA	Consultar
21361161	PRENSA IRIS-P IMC M16 ( 2x 5) GRIS O	0105	1202	<b>1,562</b>	ud	50	BOLSA	Consultar
21361200	PRENSA IRIS-P IMC M20 ( 2x 6) GRIS O	0105	1202	<b>1,683</b>	ud	50	BOLSA	Consultar
21361201	PRENSA IRIS-P IMC M20 ( 2x 7) GRIS O	0105	1202	<b>1,957</b>	ud	50	BOLSA	Consultar
21361250	PRENSA IRIS-P IMC M25 ( 2x 9) GRIS O	0105	1202	<b>2,379</b>	ud	50	BOLSA	Consultar
21441160	PRENSA IRIS-P IMC M16 ( 3x 3) GRIS	0105	1202	<b>1,276</b>	ud	50	BOLSA	Consultar
21441250	PRENSA IRIS-P IMC M25 ( 3x 7) GRIS	0105	1202	<b>2,379</b>	ud	50	BOLSA	Consultar
21441320	PRENSA IRIS-P IMC M32 ( 4x 9) GRIS	0105	1202	<b>4,445</b>	ud	25	BOLSA	Consultar
21451160	PRENSA IRIS-P IMC M16 ( 3x 3) NEGRO	0105	1202	<b>1,276</b>	ud	50	BOLSA	Consultar
21451250	PRENSA IRIS-P IMC M25 ( 3x 7) NEGRO	0105	1202	<b>2,379</b>	ud	50	BOLSA	Consultar
21451320	PRENSA IRIS-P IMC M32 ( 4x 9) NEGRO	0105	1202	<b>4,445</b>	ud	25	BOLSA	Consultar
21461160	PRENSA IRIS-P IMC M16 ( 3x 3) GRIS O	0105	1202	<b>1,276</b>	ud	50	BOLSA	Consultar
21461250	PRENSA IRIS-P IMC M25 ( 3x 7) GRIS O	0105	1202	<b>2,379</b>	ud	50	BOLSA	Consultar
21461320	PRENSA IRIS-P IMC M32 ( 4x 9) GRIS O	0105	1202	<b>4,445</b>	ud	25	BOLSA	Consultar
21541161	PRENSA IRIS-P IMC M16 ( 3x 5) GRIS	0105	1202	<b>1,667</b>	ud	50	BOLSA	Consultar
21541200	PRENSA IRIS-P IMC M20 ( 3x 5) GRIS	0105	1202	<b>1,683</b>	ud	50	BOLSA	Consultar
21541201	PRENSA IRIS-P IMC M20 ( 3x 6) GRIS	0105	1202	<b>1,957</b>	ud	50	BOLSA	Consultar
21541250	PRENSA IRIS-P IMC M25 ( 3x 8) GRIS	0105	1202	<b>2,379</b>	ud	50	BOLSA	Consultar
21551161	PRENSA IRIS-P IMC M16 ( 3x 5) NEGRO	0105	1202	<b>1,667</b>	ud	50	BOLSA	Consultar
21551200	PRENSA IRIS-P IMC M20 ( 3x 5) NEGRO	0105	1202	<b>1,683</b>	ud	50	BOLSA	Consultar
21551201	PRENSA IRIS-P IMC M20 ( 3x 6) NEGRO	0105	1202	<b>1,957</b>	ud	50	BOLSA	Consultar
21551250	PRENSA IRIS-P IMC M25 ( 3x 8) NEGRO	0105	1202	<b>2,379</b>	ud	50	BOLSA	Consultar
21561161	PRENSA IRIS-P IMC M16 ( 3x 5) GRIS O	0105	1202	<b>1,562</b>	ud	50	BOLSA	Consultar
21561200	PRENSA IRIS-P IMC M20 ( 3x 5) GRIS O	0105	1202	<b>1,683</b>	ud	50	BOLSA	Consultar
21561201	PRENSA IRIS-P IMC M20 ( 3x 6) GRIS O	0105	1202	<b>1,957</b>	ud	50	BOLSA	Consultar
21561250	PRENSA IRIS-P IMC M25 ( 3x 8) GRIS O	0105	1202	<b>2,379</b>	ud	50	BOLSA	Consultar
21641160	PRENSA IRIS-P IMC M16 ( 4x 3) GRIS	0105	1202	<b>1,276</b>	ud	50	BOLSA	Consultar
21641201	PRENSA IRIS-P IMC M20 ( 4x 5) GRIS	0105	1202	<b>1,957</b>	ud	50	BOLSA	Consultar
21641250	PRENSA IRIS-P IMC M25 ( 4x 7) GRIS	0105	1202	<b>2,379</b>	ud	50	BOLSA	Consultar
21651160	PRENSA IRIS-P IMC M16 ( 4x 3) NEGRO	0105	1202	<b>1,276</b>	ud	50	BOLSA	Consultar
21651201	PRENSA IRIS-P IMC M20 ( 4x 5) NEGRO	0105	1202	<b>1,957</b>	ud	50	BOLSA	Consultar
21651250	PRENSA IRIS-P IMC M25 ( 4x 7) NEGRO	0105	1202	<b>2,379</b>	ud	50	BOLSA	Consultar
21661160	PRENSA IRIS-P IMC M16 ( 4x 3) GRIS O	0105	1202	<b>1,276</b>	ud	50	BOLSA	Consultar
21661201	PRENSA IRIS-P IMC M20 ( 4x 5) GRIS O	0105	1202	<b>1,957</b>	ud	50	BOLSA	Consultar
21661250	PRENSA IRIS-P IMC M25 ( 4x 7) GRIS O	0105	1202	<b>2,379</b>	ud	50	BOLSA	Consultar
21841250	PRENSA IRIS-P IMC M25 ( 8x 4) GRIS	0105	1202	<b>2,379</b>	ud	50	BOLSA	Consultar
21841320	PRENSA IRIS-P IMC M32 (16x 3) GRIS	0105	1202	<b>4,445</b>	ud	25	BOLSA	Consultar
21851250	PRENSA IRIS-P IMC M25 ( 8x 4) NEGRO	0105	1202	<b>2,379</b>	ud	50	BOLSA	Consultar
21851320	PRENSA IRIS-P IMC M32 (16x 3) NEGRO	0105	1202	<b>4,445</b>	ud	25	BOLSA	Consultar
21861250	PRENSA IRIS-P IMC M25 ( 8x 4) GRIS O	0105	1202	<b>2,379</b>	ud	50	BOLSA	Consultar
21861320	PRENSA IRIS-P IMC M32 (16x 3) GRIS O	0105	1202	<b>4,445</b>	ud	25	BOLSA	Consultar

**PRENSAESTOPAS IRIS Plástico INSERTO ABIERTO PARA CABLE PG IP65**



Ref.	Descripción	SERIE	GTV	€/ud	Unidad Venta	Unidad Embala.	Embalaje	Código EAN
21940013	PRENSA IRIS-P IA PG13 (D 5) GRIS	0105	1202	<b>0,603</b>	ud	50	BOLSA	Consultar
21940016	PRENSA IRIS-P IA PG16 (D 5) GRIS	0105	1202	<b>0,687</b>	ud	50	BOLSA	Consultar
21940021	PRENSA IRIS-P IA PG21 (D 5) GRIS	0105	1202	<b>1,030</b>	ud	50	BOLSA	Consultar
21950013	PRENSA IRIS-P IA PG13 (D 5) NEGRO	0105	1202	<b>0,605</b>	ud	50	BOLSA	Consultar
21950016	PRENSA IRIS-P IA PG16 (D 5) NEGRO	0105	1202	<b>0,685</b>	ud	50	BOLSA	Consultar
21950021	PRENSA IRIS-P IA PG21 (D 5) NEGRO	0105	1202	<b>1,029</b>	ud	50	BOLSA	Consultar
21960013	PRENSA IRIS-P IA PG13 (D 5) GRIS O	0105	1202	<b>0,604</b>	ud	50	BOLSA	Consultar
21960016	PRENSA IRIS-P IA PG16 (D 5) GRIS O	0105	1202	<b>0,688</b>	ud	50	BOLSA	Consultar
21960021	PRENSA IRIS-P IA PG21 (D 5) GRIS O	0105	1202	<b>1,028</b>	ud	50	BOLSA	Consultar

**PRENSAESTOPAS IRIS Plástico INSERTO ABIERTO PARA CABLE Métrica IP65**



Ref.	Descripción	SERIE	GTV	€/ud	Unidad Venta	Unidad Embala.	Embalaje	Código EAN
21941200	PRENSA IRIS-P IA M20 (D 5) GRIS	0105	1202	<b>0,662</b>	ud	50	BOLSA	Consultar
21941250	PRENSA IRIS-P IA M25 (D 5) GRIS	0105	1202	<b>1,064</b>	ud	25	BOLSA	Consultar
21951200	PRENSA IRIS-P IA M20 (D 5) NEGRO	0105	1202	<b>0,664</b>	ud	50	BOLSA	Consultar
21951250	PRENSA IRIS-P IA M25 (D 5) NEGRO	0105	1202	<b>1,063</b>	ud	25	BOLSA	Consultar
21961200	PRENSA IRIS-P IA M20 (D 5) GRIS O	0105	1202	<b>0,663</b>	ud	50	BOLSA	Consultar
21961250	PRENSA IRIS-P IA M25 (D 5) GRIS O	0105	1202	<b>1,065</b>	ud	25	BOLSA	Consultar

**PRENSAESTOPAS IRIS-M PG IP68**



Ref.	Descripción	SERIE	GTV	€/ud	Unidad Venta	Unidad Embala.	Embalaje	Código EAN
21030007	PRENSA IRIS-M PG7 (3/ 6,5)	0105	1202	<b>2,098</b>	ud	50	BOLSA	8431927042453
21030009	PRENSA IRIS-M PG9 (4/8)	0105	1202	<b>2,499</b>	ud	50	BOLSA	8431927042460
21030011	PRENSA IRIS-M PG11 (5/10)	0105	1202	<b>2,925</b>	ud	50	BOLSA	8431927042477
21030013	PRENSA IRIS-M PG13,5 (6/12)	0105	1202	<b>3,535</b>	ud	50	BOLSA	8431927042484
21030016	PRENSA IRIS-M PG16 (10/14)	0105	1202	<b>4,153</b>	ud	50	BOLSA	8431927042491
21030021	PRENSA IRIS-M PG21 (13/18)	0105	1202	<b>6,995</b>	ud	50	BOLSA	8431927042507
21030029	PRENSA IRIS-M PG29 (18/25)	0105	1202	<b>13,277</b>	ud	25	BOLSA	8431927042514
21030036	PRENSA IRIS-M PG36 (22/32)	0105	1202	<b>21,949</b>	ud	10	BOLSA	8431927042521
21030042	PRENSA IRIS-M PG42 (30/38)	0105	1202	<b>27,686</b>	ud	5	BOLSA	8431927042538
21030048	PRENSA IRIS-M PG48 (34/44)	0105	1202	<b>39,995</b>	ud	5	BOLSA	8431927042545

**PRENSAESTOPAS IRIS-M Métrica IP68**



Ref.	Descripción	SERIE	GTV	€/ud	Unidad Venta	Unidad Embala.	Embalaje	Código EAN
21031120	PRENSA IRIS-M M12 (3/ 6,5)	0105	1202	<b>2,052</b>	ud	50	BOLSA	8431927019646
21031160	PRENSA IRIS-M M16 (4/10)	0105	1202	<b>2,462</b>	ud	50	BOLSA	8431927019653
21031200	PRENSA IRIS-M M20 (7/13)	0105	1202	<b>3,471</b>	ud	50	BOLSA	8431927019660
21031250	PRENSA IRIS-M M25 (9/17)	0105	1202	<b>4,862</b>	ud	25	BOLSA	8431927019677
21031320	PRENSA IRIS-M M32 (11/21)	0105	1202	<b>7,457</b>	ud	25	BOLSA	8431927019684
21031400	PRENSA IRIS-M M40 (19/28)	0105	1202	<b>13,060</b>	ud	10	BOLSA	8431927019691
21031500	PRENSA IRIS-M M50 (27/35)	0105	1202	<b>21,960</b>	ud	5	BOLSA	8431927019707
21031630	PRENSA IRIS-M M63 (34/48)	0105	1202	<b>41,128</b>	ud	5	BOLSA	8431927019714

**PRENSAESTOPAS IRIS -M ROSCA LARGA PG**



Ref.	Descripción	SERIE	GTV	€/ud	Unidad Venta	Unidad Embala.	Embalaje	Código EAN
21036007	PRENSA IRIS-M L PG 7 ( 3/ 6,5)	0105	1202	<b>3,042</b>	ud	100	BOLSA	8431927097613
21036009	PRENSA IRIS-M L PG 9 (4/8)	0105	1202	<b>3,624</b>	ud	50	BOLSA	8431927097620
21036011	PRENSA IRIS-M L PG11 (5/10)	0105	1202	<b>4,241</b>	ud	50	BOLSA	8431927097637
21036013	PRENSA IRIS-M L PG13,5 (6/12)	0105	1202	<b>5,126</b>	ud	50	BOLSA	8431927097644
21036016	PRENSA IRIS-M L PG16 (10/14)	0105	1202	<b>6,022</b>	ud	50	BOLSA	8431927097651
21036021	PRENSA IRIS-M L PG21 (13/18)	0105	1202	<b>10,143</b>	ud	25	BOLSA	8431927097668
21036029	PRENSA IRIS-M L PG29 (18/25)	0105	1202	<b>19,252</b>	ud	20	BOLSA	8431927097675
21036036	PRENSA IRIS-M L PG36 (22/32)	0105	1202	<b>31,826</b>	ud	10	BOLSA	8431927097682
21036042	PRENSA IRIS-M L PG42 (30/38)	0105	1202	<b>40,145</b>	ud	5	BOLSA	8431927097699
21036048	PRENSA IRIS-M L PG48 (34/44)	0105	1202	<b>57,993</b>	ud	5	BOLSA	8431927097705



**PRENSAESTOPAS IRIS -M ROSCA LARGA MÉTRICA**



Ref.	Descripción	SERIE	GTV	€/ud	Unidad Venta	Unidad Embala.	Embalaje	Código EAN
21037120	PRENSA IRIS-M L M12 ( 3/ 6,5)	0105	1202	<b>2,975</b>	ud	100	BOLSA	8431927097729
21037160	PRENSA IRIS-M L M16 ( 4/ 8)	0105	1202	<b>3,570</b>	ud	50	BOLSA	8431927097736
21037200	PRENSA IRIS-M L M20 ( 6/12)	0105	1202	<b>5,033</b>	ud	50	BOLSA	8431927097743
21037250	PRENSA IRIS-M L M25 (10/14)	0105	1202	<b>7,050</b>	ud	25	BOLSA	8431927097767
21037320	PRENSA IRIS-M L M32 (13/18)	0105	1202	<b>10,813</b>	ud	20	BOLSA	8431927097774
21037400	PRENSA IRIS-M L M40 (18/25)	0105	1202	<b>24,814</b>	ud	10	BOLSA	8431927097781
21037500	PRENSA IRIS-M L M50 (22/32)	0105	1202	<b>41,724</b>	ud	5	BOLSA	8431927097798
21037630	PRENSA IRIS-M L M63 (34/44)	0105	1202	<b>59,636</b>	ud	5	BOLSA	8431927097811

**PRENSAESTOPAS IRIS-M EMC PG**



Ref.	Descripción	SERIE	GTV	€/ud	Unidad Venta	Unidad Embala.	Embalaje	Código EAN
21034007	PRENSA IRIS-M EMC PG 7 ( 3/ 6.5)	0105	1202	<b>5,595</b>	ud	100	BOLSA	8431927097255
21034009	PRENSA IRIS-M EMC PG 9 ( 4/ 8)	0105	1202	<b>7,835</b>	ud	50	BOLSA	8431927097262
21034011	PRENSA IRIS-M EMC PG11 ( 5/10)	0105	1202	<b>9,890</b>	ud	50	BOLSA	8431927097279
21034013	PRENSA IRIS-M EMC PG13 ( 6/12)	0105	1202	<b>9,890</b>	ud	50	BOLSA	8431927097286
21034016	PRENSA IRIS-M EMC PG16 (10/14)	0105	1202	<b>13,013</b>	ud	50	BOLSA	8431927097293
21034021	PRENSA IRIS-M EMC PG21 (13/18)	0105	1202	<b>20,821</b>	ud	25	BOLSA	8431927097309
21034029	PRENSA IRIS-M EMC PG29 (18/25)	0105	1202	<b>53,398</b>	ud	20	BOLSA	8431927097316
21034036	PRENSA IRIS-M EMC PG36 (22/32)	0105	1202	<b>65,425</b>	ud	10	BOLSA	8431927097323
21034042	PRENSA IRIS-M EMC PG42 (30/38)	0105	1202	<b>65,425</b>	ud	5	BOLSA	8431927097330
21034048	PRENSA IRIS-M EMC PG48 (34/44)	0105	1202	<b>104,626</b>	ud	5	BOLSA	8431927097347

**PRENSAESTOPAS IRIS-M EMC Métrica**



Ref.	Descripción	SERIE	GTV	€/ud	Unidad Venta	Unidad Embala.	Embalaje	Código EAN
21035120	PRENSA IRIS-M EMC M12 ( 3/ 6.5)	0105	1202	<b>5,595</b>	ud	100	BOLSA	8431927097538
21035160	PRENSA IRIS-M EMC M16 ( 4/ 8)	0105	1202	<b>7,835</b>	ud	50	BOLSA	8431927097545
21035200	PRENSA IRIS-M EMC M20 ( 6/12)	0105	1202	<b>9,890</b>	ud	50	BOLSA	8431927097552
21035250	PRENSA IRIS-M EMC M25 (10/14)	0105	1202	<b>13,013</b>	ud	25	BOLSA	8431927097569
21035320	PRENSA IRIS-M EMC M32 (13/18)	0105	1202	<b>20,821</b>	ud	20	BOLSA	8431927097576
21035400	PRENSA IRIS-M EMC M40 (18/25)	0105	1202	<b>53,398</b>	ud	10	BOLSA	8431927097583
21035500	PRENSA IRIS-M EMC M50 (22/32)	0105	1202	<b>65,425</b>	ud	5	BOLSA	8431927097590
21035630	PRENSA IRIS-M EMC M63 (34/44)	0105	1202	<b>104,626</b>	ud	5	BOLSA	8431927097606

**PRENSAESTOPAS IRIS-M FLEX PG**



Ref.	Descripción	SERIE	GTV	€/ud	Unidad Venta	Unidad Embala.	Embalaje	Código EAN
21080007	PRENSA IRIS-M FLEX PG 7 ( 3/ 6.5)	0105	1202	<b>16,781</b>	ud	100	BOLSA	8431927099099
21080009	PRENSA IRIS-M FLEX PG 9 ( 4/ 8)	0105	1202	<b>20,093</b>	ud	50	BOLSA	8431927099105
21080011	PRENSA IRIS-M FLEX PG11 ( 5/10)	0105	1202	<b>23,253</b>	ud	50	BOLSA	8431927099112
21080013	PRENSA IRIS-M FLEX PG13 ( 6/12)	0105	1202	<b>25,812</b>	ud	50	BOLSA	8431927099129
21080016	PRENSA IRIS-M FLEX PG16 (10/14)	0105	1202	<b>29,800</b>	ud	50	BOLSA	8431927099136
21080021	PRENSA IRIS-M FLEX PG21 (13/18)	0105	1202	<b>34,965</b>	ud	25	BOLSA	8431927099143

**PRENSAESTOPAS IRIS-M FLEX Métrica**



Ref.	Descripción	SERIE	GTV	€/ud	Unidad Venta	Unidad Embala.	Embalaje	Código EAN
21081120	PRENSA IRIS-M FLEX M12 ( 3/ 6.5)	0105	1202	<b>16,781</b>	ud	100	BOLSA	8431927099150
21081160	PRENSA IRIS-M FLEX M16 ( 4/ 8)	0105	1202	<b>20,093</b>	ud	50	BOLSA	8431927099167
21081200	PRENSA IRIS-M FLEX M20 ( 6/12)	0105	1202	<b>25,812</b>	ud	50	BOLSA	8431927099174
21081250	PRENSA IRIS-M FLEX M25 (10/14)	0105	1202	<b>29,800</b>	ud	50	BOLSA	8431927099181
21081320	PRENSA IRIS-M FLEX M32 (13/18)	0105	1202	<b>40,506</b>	ud	50	BOLSA	8431927099198

**PRENSAESTOPAS IRIS-M FLEX ROSCA LARGA PG**



Ref.	Descripción	SERIE	GTV	€/ud	Unidad Venta	Unidad Embala.	Embalaje	Código EAN
21082007	PRENSA IRIS-M FLEX-L PG 7 ( 3/ 6.5)	0105	1202	<b>20,977</b>	ud	100	BOLSA	8431927099204
21082009	PRENSA IRIS-M FLEX-L PG 9 ( 4/ 8)	0105	1202	<b>25,116</b>	ud	50	BOLSA	8431927099211
21082011	PRENSA IRIS-M FLEX-L PG11 ( 5/10)	0105	1202	<b>29,066</b>	ud	50	BOLSA	8431927099228
21082013	PRENSA IRIS-M FLEX-L PG13 ( 6/12)	0105	1202	<b>32,265</b>	ud	50	BOLSA	8431927099235
21082016	PRENSA IRIS-M FLEX-L PG16 (10/14)	0105	1202	<b>37,250</b>	ud	50	BOLSA	8431927099242
21082021	PRENSA IRIS-M FLEX-L PG21 (13/18)	0105	1202	<b>46,281</b>	ud	25	BOLSA	8431927099259

**PRENSAESTOPAS IRIS-M FLEX ROSCA LARGA Métrica**



Ref.	Descripción	SERIE	GTV	€/ud	Unidad Venta	Unidad Embala.	Embalaje	Código EAN
21083120	PRENSA IRIS-M FLEX-L M12 ( 3/ 6.5)	0105	1202	<b>20,977</b>	ud	100	BOLSA	8431927099266
21083160	PRENSA IRIS-M FLEX-L M16 ( 4/ 8)	0105	1202	<b>25,116</b>	ud	50	BOLSA	8431927099273
21083200	PRENSA IRIS-M FLEX-L M20 ( 6/12)	0105	1202	<b>32,265</b>	ud	50	BOLSA	8431927099280
21083250	PRENSA IRIS-M FLEX-L M25 (10/14)	0105	1202	<b>37,250</b>	ud	50	BOLSA	8431927099297
21083320	PRENSA IRIS-M FLEX-L M32 (13/18)	0105	1202	<b>50,649</b>	ud	50	BOLSA	8431927099303

**PRENSAESTOPAS IRIS-M ALTA TEMPERATURA PG**



Ref.	Descripción	SERIE	GTV	€/ud	Unidad Venta	Unidad Embala.	Embalaje	Código EAN
21038007	PRENSA IRIS-M H.TEMP PG 7 ( 3/ 6.5)	0105	1202	<b>18,875</b>	ud	100	BOLSA	8431927097835
21038009	PRENSA IRIS-M H.TEMP PG 9 ( 4/ 8)	0105	1202	<b>20,755</b>	ud	50	BOLSA	8431927097842
21038011	PRENSA IRIS-M H.TEMP PG11 ( 5/10)	0105	1202	<b>25,067</b>	ud	50	BOLSA	8431927097859
21038013	PRENSA IRIS-M H.TEMP PG13 ( 6/12)	0105	1202	<b>27,275</b>	ud	50	BOLSA	8431927097866
21038016	PRENSA IRIS-M H.TEMP PG16 (10/14)	0105	1202	<b>27,975</b>	ud	50	BOLSA	8431927097873
21038021	PRENSA IRIS-M H.TEMP PG21 (13/18)	0105	1202	<b>56,375</b>	ud	25	BOLSA	8431927097880
21038029	PRENSA IRIS-M H.TEMP PG29 (18/25)	0105	1202	<b>68,322</b>	ud	20	BOLSA	8431927097897
21038036	PRENSA IRIS-M H.TEMP PG36 (22/32)	0105	1202	<b>165,275</b>	ud	10	BOLSA	8431927097903
21038042	PRENSA IRIS-M H.TEMP PG42 (30/38)	0105	1202	<b>200,865</b>	ud	5	BOLSA	8431927097910
21038048	PRENSA IRIS-M H.TEMP PG48 (34/44)	0105	1202	<b>209,884</b>	ud	5	BOLSA	8431927097927

**PRENSAESTOPAS IRIS-M ALTA TEMPERATURA MÉTRICA**



Ref.	Descripción	SERIE	GTV	€/ud	Unidad Venta	Unidad Embala.	Embalaje	Código EAN
21039120	PRENSA IRIS-M H.TEMP M12 ( 3/ 6.5)	0105	1202	<b>19,785</b>	ud	100	BOLSA	8431927097934
21039160	PRENSA IRIS-M H.TEMP M16 ( 4/ 8)	0105	1202	<b>19,775</b>	ud	50	BOLSA	8431927097941
21039200	PRENSA IRIS-M H.TEMP M20 ( 6/12)	0105	1202	<b>25,975</b>	ud	50	BOLSA	8431927097958
21039250	PRENSA IRIS-M H.TEMP M25 (10/14)	0105	1202	<b>34,550</b>	ud	25	BOLSA	8431927097965
21039320	PRENSA IRIS-M H.TEMP M32 (13/18)	0105	1202	<b>66,875</b>	ud	20	BOLSA	8431927097972
21039400	PRENSA IRIS-M H.TEMP M40 (18/25)	0105	1202	<b>102,375</b>	ud	10	BOLSA	8431927097989
21039500	PRENSA IRIS-M H.TEMP M50 (22/32)	0105	1202	<b>179,985</b>	ud	5	BOLSA	8431927097996
21039630	PRENSA IRIS-M H.TEMP M63 (34/44)	0105	1202	<b>199,875</b>	ud	5	BOLSA	8431927098009

**PRENSAESTOPAS IRIS-M INOX PG**



Ref.	Descripción	SERIE	GTV	€/ud	Unidad Venta	Unidad Embala.	Embalaje	Código EAN
21084007	PRENSA IRIS-M INOX PG 7 ( 3/ 6.5)	0105	1202	<b>Consultar</b>	ud	100	BOLSA	8431927097439
21084009	PRENSA IRIS-M INOX PG 9 ( 4/ 8)	0105	1202	<b>Consultar</b>	ud	50	BOLSA	8431927097446
21084011	PRENSA IRIS-M INOX PG11 ( 5/10)	0105	1202	<b>Consultar</b>	ud	50	BOLSA	8431927097453
21084013	PRENSA IRIS-M INOX PG13 ( 6/12)	0105	1202	<b>Consultar</b>	ud	50	BOLSA	8431927097460
21084016	PRENSA IRIS-M INOX PG16 (10/14)	0105	1202	<b>Consultar</b>	ud	50	BOLSA	8431927097477
21084021	PRENSA IRIS-M INOX PG21 (13/18)	0105	1202	<b>Consultar</b>	ud	25	BOLSA	8431927097484
21084029	PRENSA IRIS-M INOX PG29 (18/25)	0105	1202	<b>Consultar</b>	ud	20	BOLSA	8431927097491
21084036	PRENSA IRIS-M INOX PG36 (22/32)	0105	1202	<b>Consultar</b>	ud	10	BOLSA	8431927097507
21084042	PRENSA IRIS-M INOX PG42 (30/38)	0105	1202	<b>Consultar</b>	ud	5	BOLSA	8431927097514
21084048	PRENSA IRIS-M INOX PG48 (33/44)	0105	1202	<b>Consultar</b>	ud	5	BOLSA	8431927097521

**PRENSAESTOPAS IRIS-M INOX Métrica**



Ref.	Descripción	SERIE	GTV	€/ud	Unidad Venta	Unidad Embala.	Embalaje	Código EAN
21085120	PRENSA IRIS-M INOX M12 ( 3/ 6.5)	0105	1202	<b>Consultar</b>	ud	100	BOLSA	8431927097354
21085160	PRENSA IRIS-M INOX M16 ( 4/ 8)	0105	1202	<b>Consultar</b>	ud	50	BOLSA	8431927097361
21085200	PRENSA IRIS-M INOX M20 ( 6/12)	0105	1202	<b>Consultar</b>	ud	50	BOLSA	8431927097378
21085250	PRENSA IRIS-M INOX M25 (10/14)	0105	1202	<b>Consultar</b>	ud	25	BOLSA	8431927097385
21085320	PRENSA IRIS-M INOX M32 (13/18)	0105	1202	<b>Consultar</b>	ud	20	BOLSA	8431927097392
21085400	PRENSA IRIS-M INOX M40 (18/25)	0105	1202	<b>Consultar</b>	ud	10	BOLSA	8431927097408
21085500	PRENSA IRIS-M INOX M50 (22/32)	0105	1202	<b>Consultar</b>	ud	5	BOLSA	8431927097415
21085630	PRENSA IRIS-M INOX M63 (33/44)	0105	1202	<b>Consultar</b>	ud	5	BOLSA	8431927097422

**PRENSAESTOPAS IRIS-M XL**



Ref.	Descripción	SERIE	GTV	€/ud	Unidad Venta	Unidad Embala.	Embalaje	Código EAN
21087630	PRENSA IRIS-M XL M63 (45/55)	0105	1202	<b>101,000</b>	ud	5	BOLSA	8431927099051
21087750	PRENSA IRIS-M XL M75 (50/63)	0105	1202	<b>150,000</b>	ud	2	BOLSA	8431927099068
21087800	PRENSA IRIS-M XL M80 (50/63)	0105	1202	<b>200,000</b>	ud	2	BOLSA	8431927099075
21087900	PRENSA IRIS-M XL M90 (60/70)	0105	1202	<b>270,000</b>	ud	1	BOLSA	8431927099082

**PRENSAESTOPAS IRIS-M Metálico INSERTO CABLE PLANO PG IP68**



Ref.	Descripción	SERIE	GTV	€/ud	Unidad Venta	Unidad Embala.	Embalaje	Código EAN
21130016	PRENSA IRIS-M IP PG16 (7x13)	0105	1202	<b>3,945</b>	ud	50	BOLSA	Consultar
21130021	PRENSA IRIS-M IP PG21 (7x15)	0105	1202	<b>6,542</b>	ud	50	BOLSA	Consultar
21130029	PRENSA IRIS-M IP PG29 (8x22)	0105	1202	<b>13,294</b>	ud	25	BOLSA	Consultar
21130036	PRENSA IRIS-M IP PG36 (10x28)	0105	1202	<b>22,005</b>	ud	10	BOLSA	Consultar
21130042	PRENSA IRIS-M IP PG42 (12x33)	0105	1202	<b>27,896</b>	ud	5	BOLSA	Consultar
21130048	PRENSA IRIS-M IP PG48 (14x45)	0105	1202	<b>40,275</b>	ud	5	BOLSA	Consultar

**PRENSAESTOPAS IRIS-M Metálico INSERTO CABLE PLANO Métrica PG IP68**



Ref.	Descripción	SERIE	GTV	€/ud	Unidad Venta	Unidad Embala.	Embalaje	Código EAN
21131250	PRENSA IRIS-M IP M25 (7x13)	0105	1202	<b>4,872</b>	ud	25	BOLSA	Consultar
21131320	PRENSA IRIS-M IP M32 (7x15)	0105	1202	<b>7,469</b>	ud	25	BOLSA	Consultar
21131400	PRENSA IRIS-M IP M40 (8x22)	0105	1202	<b>13,078</b>	ud	10	BOLSA	Consultar
21131500	PRENSA IRIS-M IP M50 (10x28)	0105	1202	<b>22,016</b>	ud	5	BOLSA	Consultar
21131630	PRENSA IRIS-M IP M63 (14x45)	0105	1202	<b>41,408</b>	ud	5	BOLSA	Consultar

**PRENSAESTOPAS IRIS-M Metálico INSERTO MULTICABLE PG IP68**



Ref.	Descripción	SERIE	GTV	€/ud	Unidad Venta	Unidad Embala.	Embalaje	Código EAN
21230009	PRENSA IRIS-M IMC PG 9 (2x 3)	0105	1202	<b>3,082</b>	ud	50	BOLSA	Consultar
21230011	PRENSA IRIS-M IMC PG11 (2x 4)	0105	1202	<b>3,645</b>	ud	50	BOLSA	Consultar
21330011	PRENSA IRIS-M IMC PG11 (2x 5)	0105	1202	<b>3,645</b>	ud	50	BOLSA	Consultar
21330013	PRENSA IRIS-M IMC PG13 (2x 6)	0105	1202	<b>4,505</b>	ud	50	BOLSA	Consultar
21330016	PRENSA IRIS-M IMC PG16 (2x 7)	0105	1202	<b>5,001</b>	ud	50	BOLSA	Consultar
21330021	PRENSA IRIS-M IMC PG21 (2x 9)	0105	1202	<b>7,859</b>	ud	50	BOLSA	Consultar
21430009	PRENSA IRIS-M IMC PG 9 (3x 3)	0105	1202	<b>3,082</b>	ud	50	BOLSA	Consultar
21430021	PRENSA IRIS-M IMC PG21 (3x 7)	0105	1202	<b>7,859</b>	ud	50	BOLSA	Consultar
21430029	PRENSA IRIS-M IMC PG29 (4x 9)	0105	1202	<b>15,550</b>	ud	25	BOLSA	Consultar
21530011	PRENSA IRIS-M IMC PG11 (3x 5)	0105	1202	<b>3,645</b>	ud	50	BOLSA	Consultar
21530013	PRENSA IRIS-M IMC PG13 (3x 5)	0105	1202	<b>4,505</b>	ud	50	BOLSA	Consultar
21530016	PRENSA IRIS-M IMC PG16 (3x 6)	0105	1202	<b>5,001</b>	ud	50	BOLSA	Consultar
21530021	PRENSA IRIS-M IMC PG21 (3x 8)	0105	1202	<b>7,859</b>	ud	50	BOLSA	Consultar
21630009	PRENSA IRIS-M IMC PG 9 (4x 3)	0105	1202	<b>3,082</b>	ud	50	BOLSA	Consultar
21630016	PRENSA IRIS-M IMC PG16 (4x 5)	0105	1202	<b>5,001</b>	ud	50	BOLSA	Consultar
21630021	PRENSA IRIS-M IMC PG21 (4x 7)	0105	1202	<b>7,859</b>	ud	50	BOLSA	Consultar
21830021	PRENSA IRIS-M IMC PG21 (8x 4)	0105	1202	<b>7,859</b>	ud	50	BOLSA	Consultar
21830029	PRENSA IRIS-M IMC PG29 (16x 3)	0105	1202	<b>15,550</b>	ud	25	BOLSA	Consultar

**PRENSAESTOPAS IRIS-M Metálico INSERTO MULTICABLE Métrica IP68**



Ref.	Descripción	SERIE	GTV	€/ud	Unidad Venta	Unidad Embala.	Embalaje	Código EAN
21231160	PRENSA IRIS-M IMC M16 (2x 3)	0105	1202	<b>3,195</b>	ud	50	BOLSA	Consultar
21331200	PRENSA IRIS-M IMC M20 (2x 6)	0105	1202	<b>4,505</b>	ud	50	BOLSA	Consultar
21331250	PRENSA IRIS-M IMC M25 (2x 7)	0105	1202	<b>5,928</b>	ud	25	BOLSA	Consultar
21331320	PRENSA IRIS-M IMC M32 (2x 9)	0105	1202	<b>8,786</b>	ud	25	BOLSA	Consultar
21431160	PRENSA IRIS-M IMC M16 (3x 3)	0105	1202	<b>3,195</b>	ud	50	BOLSA	Consultar
21431320	PRENSA IRIS-M IMC M32 (3x 7)	0105	1202	<b>8,786</b>	ud	25	BOLSA	Consultar
21431400	PRENSA IRIS-M IMC M40 (4x 9)	0105	1202	<b>15,334</b>	ud	10	BOLSA	Consultar
21531200	PRENSA IRIS-M IMC M20 (3x 5)	0105	1202	<b>4,505</b>	ud	50	BOLSA	Consultar
21531250	PRENSA IRIS-M IMC M25 (3x 6)	0105	1202	<b>5,928</b>	ud	25	BOLSA	Consultar
21531320	PRENSA IRIS-M IMC M32 (3x 8)	0105	1202	<b>8,786</b>	ud	25	BOLSA	Consultar
21631160	PRENSA IRIS-M IMC M16 (4x 3)	0105	1202	<b>3,195</b>	ud	50	BOLSA	Consultar
21631250	PRENSA IRIS-M IMC M25 (4x 5)	0105	1202	<b>5,928</b>	ud	25	BOLSA	Consultar
21631320	PRENSA IRIS-M IMC M32 (4x 7)	0105	1202	<b>8,786</b>	ud	25	BOLSA	Consultar
21831320	PRENSA IRIS-M IMC M32 (8x 4)	0105	1202	<b>8,786</b>	ud	25	BOLSA	Consultar
21831400	PRENSA IRIS-M IMC M40 (16x 3)	0105	1202	<b>15,334</b>	ud	10	BOLSA	Consultar

**PRENSAESTOPAS IRIS-M Metálico INSERTO PARA CABLE ABIERTO PG IP68**

Ref.	Descripción	SERIE	GTV	€/ud	Unidad Venta	Unidad Embala.	Embalaje	Código EAN
21930013	PRENSA IRIS-M-IA PG13 (D 5)	0105	1202	<b>3,484</b>	ud	50	BOLSA	Consultar
21930016	PRENSA IRIS-M-IA PG16 (D 5)	0105	1202	<b>3,949</b>	ud	50	BOLSA	Consultar
21930021	PRENSA IRIS-M-IA PG21 (D 5)	0105	1202	<b>6,545</b>	ud	50	BOLSA	Consultar

**PRENSAESTOPAS IRIS-M Metálico INSERTO PARA CABLE ABIERTO Métrica IP68**

Ref.	Descripción	SERIE	GTV	€/ud	Unidad Venta	Unidad Embala.	Embalaje	Código EAN
21931200	PRENSA IRIS-M-IA M20 (D 5)	0105	1202	<b>3,484</b>	ud	50	BOLSA	Consultar
21931250	PRENSA IRIS-M-IA M25 (D 5)	0105	1202	<b>4,876</b>	ud	25	BOLSA	Consultar
21931320	PRENSA IRIS-M-IA M32 (D 5)	0105	1202	<b>7,472</b>	ud	25	BOLSA	Consultar

**PRENSAESTOPAS IRIS-P AIR PG**

Ref.	Descripción	SERIE	GTV	€/ud	Unidad Venta	Unidad Embala.	Embalaje	Código EAN
21012007	PRENSA IRIS-P AIR PG 7 ( 4/8) GRIS	0105	1202	<b>4,461</b>	ud	100	BOLSA	8431927097156
21012009	PRENSA IRIS-P AIR PG 9 ( 4/8) GRIS	0105	1202	<b>4,461</b>	ud	50	BOLSA	8431927097163
21022007	PRENSA IRIS-P AIR PG 7 ( 4/8) NEGR	0105	1202	<b>4,461</b>	ud	100	BOLSA	8431927097200
21022009	PRENSA IRIS-P AIR PG 9 ( 4/8) NEGR	0105	1202	<b>4,461</b>	ud	50	BOLSA	8431927097217

**PRENSAESTOPAS IRIS-P AIR Métrica**

Ref.	Descripción	SERIE	GTV	€/ud	Unidad Venta	Unidad Embala.	Embalaje	Código EAN
21013120	PRENSA IRIS-P AIR M12 ( 4/6.5) GRIS	0105	1202	<b>4,461</b>	ud	100	BOLSA	8431927097170
21013160	PRENSA IRIS-P AIR M16 ( 4/8) GRIS	0105	1202	<b>6,321</b>	ud	50	BOLSA	8431927097187
21013161	PRENSA IRIS-P AIR M16 ( 5/10) GRIS	0105	1202	<b>6,321</b>	ud	50	BOLSA	8431927097194
21023120	PRENSA IRIS-P AIR M12 ( 4/6.5) NEGR	0105	1202	<b>4,461</b>	ud	100	BOLSA	8431927097224
21023160	PRENSA IRIS-P AIR M16 ( 4/8) MEGR	0105	1202	<b>6,321</b>	ud	50	BOLSA	8431927097231
21023161	PRENSA IRIS-P AIR M16 ( 5/10) NEGR	0105	1202	<b>6,321</b>	ud	50	BOLSA	8431927097248

**PRENSAESTOPAS IRIS-M AIR PG**

Ref.	Descripción	SERIE	GTV	€/ud	Unidad Venta	Unidad Embala.	Embalaje	Código EAN
21074007	PRENSA IRIS-M AIR PG 7 ( 4/ 8)	0105	1202	<b>9,987</b>	ud	100	BOLSA	8431927098757
21074009	PRENSA IRIS-M AIR PG 9 ( 4/ 8)	0105	1202	<b>10,639</b>	ud	50	BOLSA	8431927098764
21074011	PRENSA IRIS-M AIR PG11 ( 5/10)	0105	1202	<b>12,592</b>	ud	50	BOLSA	8431927098771
21074013	PRENSA IRIS-M AIR PG13 ( 6/12)	0105	1202	<b>14,112</b>	ud	50	BOLSA	8431927098788

**PRENSAESTOPAS IRIS-M AIR Métrica**

Ref.	Descripción	SERIE	GTV	€/ud	Unidad Venta	Unidad Embala.	Embalaje	Código EAN
21075120	PRENSA IRIS-M AIR M12 ( 4/ 8)	0105	1202	<b>12,158</b>	ud	100	BOLSA	8431927098825
21075160	PRENSA IRIS-M AIR M16 ( 4/ 8)	0105	1202	<b>13,171</b>	ud	50	BOLSA	8431927098832
21075161	PRENSA IRIS-M AIR M16 ( 5/10)	0105	1202	<b>14,438</b>	ud	50	BOLSA	8431927098849
21075200	PRENSA IRIS-M AIR M20 ( 6/12)	0105	1202	<b>16,971</b>	ud	50	BOLSA	8431927098856

**PRENSAESTOPAS IRIS-M AIR ROSCA LARGA**

Ref.	Descripción	SERIE	GTV	€/ud	Unidad Venta	Unidad Embala.	Embalaje	Código EAN
21076007	PRENSA IRIS-M AIR-L PG 7 ( 4/ 8)	0105	1202	<b>10,421</b>	ud	100	BOLSA	8431927098863
21076009	PRENSA IRIS-M AIR-L PG 9 ( 4/ 8)	0105	1202	<b>11,290</b>	ud	50	BOLSA	8431927098870
21076011	PRENSA IRIS-M AIR-L PG11 ( 5/10)	0105	1202	<b>13,244</b>	ud	50	BOLSA	8431927098887
21076013	PRENSA IRIS-M AIR-L PG13 ( 6/12)	0105	1202	<b>14,329</b>	ud	50	BOLSA	8431927098894

**PRENSAESTOPAS IRIS-M AIR ROSCA LARGA**

Ref.	Descripción	SERIE	GTV	€/ud	Unidad Venta	Unidad Embala.	Embalaje	Código EAN
21077120	PRENSA IRIS-M AIR-L M12 ( 4/ 8)	0105	1202	<b>12,412</b>	ud	100	BOLSA	8431927098900
21077160	PRENSA IRIS-M AIR-L M16 ( 4/ 8)	0105	1202	<b>13,425</b>	ud	50	BOLSA	8431927098917
21077161	PRENSA IRIS-M AIR-L M16 ( 5/10)	0105	1202	<b>14,691</b>	ud	50	BOLSA	8431927098924

**PRENSAESTOPAS IRIS-M AIR-INOX PG**



Ref.	Descripción	SERIE	GTV	€/ud	Unidad Venta	Unidad Embala.	Embalaje	Código EAN
21070007	PRENSA IRIS-M AIR-INOX PG 7 ( 4/ 8)	0105	1202	Consultar	ud	100	BOLSA	8431927098634
21070009	PRENSA IRIS-M AIR-INOX PG 9 ( 4/ 8)	0105	1202	Consultar	ud	50	BOLSA	8431927098641
21070011	PRENSA IRIS-M AIR-INOX PG11 ( 5/10)	0105	1202	Consultar	ud	50	BOLSA	8431927098658
21070013	PRENSA IRIS-M AIR-INOX PG13 ( 6/12)	0105	1202	Consultar	ud	50	BOLSA	8431927098665

**PRENSAESTOPAS IRIS-M AIR-INOX Métrica**



Ref.	Descripción	SERIE	GTV	€/ud	Unidad Venta	Unidad Embala.	Embalaje	Código EAN
21071120	PRENSA IRIS-M AIR-INOX M12 ( 4/ 8)	0105	1202	Consultar	ud	100	BOLSA	8431927098672
21071160	PRENSA IRIS-M AIR-INOX M16 ( 4/ 8)	0105	1202	Consultar	ud	50	BOLSA	8431927098689
21071161	PRENSA IRIS-M AIR-INOX M16 ( 5/10)	0105	1202	Consultar	ud	50	BOLSA	8431927098696
21071200	PRENSA IRIS-M AIR-INOX M20 ( 6/12)	0105	1202	Consultar	ud	50	BOLSA	8431927098702

**PRENSAESTOPAS IRIS-M AIR-INOX ROSCA LARGA PG**



Ref.	Descripción	SERIE	GTV	€/ud	Unidad Venta	Unidad Embala.	Embalaje	Código EAN
21072007	PRENSA IRIS-M AIR-INOX-L PG 7(4/ 8)	0105	1202	Consultar	ud	100	BOLSA	8431927098719
21072009	PRENSA IRIS-M AIR-INOX-L PG 9(4/ 8)	0105	1202	Consultar	ud	50	BOLSA	8431927098726
21072011	PRENSA IRIS-M AIR-INOX-L PG11(5/10)	0105	1202	Consultar	ud	50	BOLSA	8431927098733
21072013	PRENSA IRIS-M AIR-INOX-L PG13(6/12)	0105	1202	Consultar	ud	50	BOLSA	8431927098740

**PRENSAESTOPAS IRIS-M AIR-INOX ROSCA LARGA Métrica**



Ref.	Descripción	SERIE	GTV	€/ud	Unidad Venta	Unidad Embala.	Embalaje	Código EAN
21073120	PRENSA IRIS-M AIR-INOX-L M12(4/ 8)	0105	1202	Consultar	ud	100	BOLSA	8431927098795
21073160	PRENSA IRIS-M AIR-INOX-L M16(4/ 8)	0105	1202	Consultar	ud	50	BOLSA	8431927098801
21073161	PRENSA IRIS-M AIR-INOX-L M16(5/10)	0105	1202	Consultar	ud	50	BOLSA	8431927098818

**INSERTO PLANO IP68**



Ref.	Descripción	SERIE	GTV	€/ud	Unidad Venta	Unidad Embala.	Embalaje	Código EAN
40030116	INSERTO-IP PG16/M25 D 7x13	0105	1301	0,010	ud	25	BOLSA	8431927095534
40030121	INSERTO-IP PG21/M32 D 7x15	0105	1301	0,012	ud	25	BOLSA	8431927095541
40030129	INSERTO-IP PG29/M40 D 8x22	0105	1301	0,017	ud	5	BOLSA	8431927095558
40030136	INSERTO-IP PG36/M50 D10x28	0105	1301	0,056	ud	5	BOLSA	8431927095565
40030142	INSERTO-IP PG42 D12x33	0105	1301	0,210	ud	5	BOLSA	8431927095572
40030148	INSERTO-IP PG48/M63 D14x45	0105	1301	0,280	ud	5	BOLSA	8431927095589

**INSERTO MULTICABLE IP68**



Ref.	Descripción	SERIE	GTV	€/ud	Unidad Venta	Unidad Embala.	Embalaje	Código EAN
40030209	INSERTO-IMC PG 9/M16 D 2x 3	0105	1301	0,733	ud	50	BOLSA	8431927095596
40030211	INSERTO-IMC PG11/M20 D 2x 4	0105	1301	0,913	ud	50	BOLSA	8431927095602
40030311	INSERTO-IMC PG11/M16 D 2x 5	0105	1301	0,913	ud	50	BOLSA	8431927095619
40030313	INSERTO-IMC PG13/M20 D 2x 6	0105	1301	1,034	ud	50	BOLSA	8431927095626
40030316	INSERTO-IMC PG16/M25 D 2x 7	0105	1301	1,067	ud	25	BOLSA	8431927095633
40030321	INSERTO-IMC PG21/M32 D 2x 9	0105	1301	1,329	ud	25	BOLSA	8431927095640
40030409	INSERTO-IMC PG 9/M16 D 3x 3	0105	1301	0,733	ud	50	BOLSA	8431927095657
40030421	INSERTO-IMC PG21/M32 D 3x 7	0105	1301	1,329	ud	25	BOLSA	8431927095664
40030429	INSERTO-IMC PG29/M40 D 4x 9	0105	1301	2,274	ud	5	BOLSA	8431927095671
40030511	INSERTO-IMC PG11/M20 D 3x 5	0105	1301	0,913	ud	50	BOLSA	8431927095688
40030513	INSERTO-IMC PG13/M20 D 3x 5	0105	1301	1,034	ud	50	BOLSA	8431927095695
40030516	INSERTO-IMC PG16/M25 D 3x 6	0105	1301	1,067	ud	25	BOLSA	8431927095701
40030521	INSERTO-IMC PG21/M32 D 3x 8	0105	1301	1,329	ud	25	BOLSA	8431927095718
40030609	INSERTO-IMC PG 9/M16 D 4x 3	0105	1301	0,733	ud	50	BOLSA	8431927095725
40030616	INSERTO-IMC PG16/M25 D 4x 5	0105	1301	1,067	ud	25	BOLSA	8431927095732
40030621	INSERTO-IMC PG21/M32 D 4x 7	0105	1301	1,329	ud	25	BOLSA	8431927095749
40030821	INSERTO-IMC PG21/M32 D 8x 4	0105	1301	1,329	ud	25	BOLSA	8431927095756
40030829	INSERTO-IMC PG29/M40 D16x 3	0105	1301	2,274	ud	5	BOLSA	8431927095763

**INSERTO ABIERTO IP68**

Ref.	Descripción	SERIE	GTV	€/ud	Unidad Venta	Unidad Embala.	Embalaje	Código EAN
40030913	INSERTO-IA PG13/M20 D 5	0105	1202	<b>0,013</b>	ud	50	BOLSA	8431927095770
40030916	INSERTO-IA PG16/M25 D 5	0105	1202	<b>0,014</b>	ud	25	BOLSA	8431927095787
40030921	INSERTO-IA PG21/M32 D 5	0105	1202	<b>0,015</b>	ud	25	BOLSA	8431927095794

**TOPE PROTECTOR NEGRO**

Ref.	Descripción	SERIE	GTV	€/ud	Unidad Venta	Unidad Embala.	Embalaje	Código EAN
44040007	TOPE PROTECTOR PG 7/M12 NEGR	0105	1301	<b>0,299</b>	ud	1000	BOLSA	8431927100931
44040009	TOPE PROTECTOR PG 9/M16 NEGR	0105	1301	<b>0,305</b>	ud	1000	BOLSA	8431927100948
44040011	TOPE PROTECTOR PG11/M16 NEGR	0105	1301	<b>0,305</b>	ud	1000	BOLSA	8431927100955
44040013	TOPE PROTECTOR PG13/M20 NEGR	0105	1301	<b>0,322</b>	ud	500	BOLSA	8431927100962
44040016	TOPE PROTECTOR PG16/M20 NEGR	0105	1301	<b>0,442</b>	ud	500	BOLSA	8431927100979
44040021	TOPE PROTECTOR PG21/M25 NEGR	0105	1301	<b>0,559</b>	ud	500	BOLSA	8431927100986
44040029	TOPE PROTECTOR PG29/M32 NEGR	0105	1301	<b>0,849</b>	ud	200	BOLSA	8431927100993
44040036	TOPE PROTECTOR PG36/M40 NEGR	0105	1301	<b>1,146</b>	ud	100	BOLSA	8431927101006
44040042	TOPE PROTECTOR PG42/M50 NEGR	0105	1301	<b>1,369</b>	ud	50	BOLSA	8431927101013
44040048	TOPE PROTECTOR PG48/M63 NEGR	0105	1301	<b>2,016</b>	ud	50	BOLSA	8431927101020

**TOPE PROTECTOR ROJO**

Ref.	Descripción	SERIE	GTV	€/ud	Unidad Venta	Unidad Embala.	Embalaje	Código EAN
44041007	TOPE PROTECTOR PG 7/M12 ROJO	0105	1301	<b>0,299</b>	ud	1000	BOLSA	8431927101037
44041009	TOPE PROTECTOR PG 9/M16 ROJO	0105	1301	<b>0,305</b>	ud	1000	BOLSA	8431927101044
44041011	TOPE PROTECTOR PG11/M16 ROJO	0105	1301	<b>0,305</b>	ud	1000	BOLSA	8431927101051
44041013	TOPE PROTECTOR PG13/M20 ROJO	0105	1301	<b>0,322</b>	ud	500	BOLSA	8431927101068
44041016	TOPE PROTECTOR PG16/M20 ROJO	0105	1301	<b>0,442</b>	ud	500	BOLSA	8431927101075
44041021	TOPE PROTECTOR PG21/M25 ROJO	0105	1301	<b>0,559</b>	ud	500	BOLSA	8431927101082
44041029	TOPE PROTECTOR PG29/M32 ROJO	0105	1301	<b>0,849</b>	ud	200	BOLSA	8431927101099
44041036	TOPE PROTECTOR PG36/M40 ROJO	0105	1301	<b>1,146</b>	ud	100	BOLSA	8431927101105
44041042	TOPE PROTECTOR PG42/M50 ROJO	0105	1301	<b>1,369</b>	ud	50	BOLSA	8431927101112
44041048	TOPE PROTECTOR PG48/M63 ROJO	0105	1301	<b>2,016</b>	ud	50	BOLSA	8431927101129

# PRENSAESTOPAS IP 68 AMBIENTES INDUSTRIALES Y ESPECIALES

**PRENSAESTOPAS HSK-K PG GRIS IP68**

Ref.	Descripción	SERIE	GTV	€/ud	Unidad Venta	Unidad Embala.	Embalaje	Código EAN
22010007	PRENSA HSK-K PG 7 (3/ 6,5) GRIS	0105	1203	<b>1,375</b>	ud	50	BOLSA	8431927001139
22010009	PRENSA HSK-K PG 9 (4/ 8) GRIS	0105	1203	<b>1,408</b>	ud	50	BOLSA	8431927001146
22010011	PRENSA HSK-K PG11 (5/10) GRIS	0105	1203	<b>1,716</b>	ud	50	BOLSA	8431927001153
22010013	PRENSA HSK-K PG13 (6/12) GRIS	0105	1203	<b>1,892</b>	ud	50	BOLSA	8431927001160
22010016	PRENSA HSK-K PG16 (10/14) GRIS	0105	1203	<b>2,079</b>	ud	50	BOLSA	8431927001177
22010021	PRENSA HSK-K PG21 (13/18) GRIS	0105	1203	<b>3,003</b>	ud	50	BOLSA	8431927001184
22010029	PRENSA HSK-K PG29 (18/25) GRIS	0105	1203	<b>5,929</b>	ud	25	BOLSA	8431927001191
22010036	PRENSA HSK-K PG36 (22/32) GRIS	0105	1203	<b>21,494</b>	ud	10	BOLSA	8431927001207
22010048	PRENSA HSK-K PG48 (37/44) GRIS	0105	1203	<b>39,589</b>	ud	5	BOLSA	8431927001214

**PRENSAESTOPAS HSK-K PG NEGRO IP68 (BAJO PEDIDO, CONSULTAR REFERENCIAS)**

Ref.	Descripción	SERIE	GTV	€/ud	Unidad Venta	Unidad Embala.	Embalaje	Código EAN
22012007	PRENSA HSK-K PG 7 (3/ 6) NEGR	0105	1203	<b>1,375</b>	ud	50	BOLSA	8431927019721
22012009	PRENSA HSK-K PG 9 (4/ 8) NEGR	0105	1203	<b>1,408</b>	ud	50	BOLSA	8431927019738
22012011	PRENSA HSK-K PG11 (5/10) NEGR	0105	1203	<b>1,716</b>	ud	50	BOLSA	8431927019745
22012013	PRENSA HSK-K PG13 (6/12) NEGR	0105	1203	<b>1,892</b>	ud	50	BOLSA	8431927019752
22012016	PRENSA HSK-K PG16 (10/14) NEGR	0105	1203	<b>2,079</b>	ud	50	BOLSA	8431927019769
22012021	PRENSA HSK-K PG21 (13/18) NEGR	0105	1203	<b>3,003</b>	ud	50	BOLSA	8431927019776
22012029	PRENSA HSK-K PG29 (18/25) NEGR	0105	1203	<b>5,929</b>	ud	25	BOLSA	8431927019783
22012036	PRENSA HSK-K PG36 (22/32) NEGR	0105	1203	<b>21,494</b>	ud	10	BOLSA	8431927019790
22012048	PRENSA HSK-K PG48 (37/44) NEGR	0105	1203	<b>39,589</b>	ud	5	BOLSA	8431927019806

**PRENSAESTOPAS HSK-K Métrica GRIS IP68**



Ref.	Descripción	SERIE	GTV	€/ud	Unidad Venta	Unidad Embala.	Embalaje	Código EAN
22011120	PRENSA HSK-K M12 (3/ 6,5) GRIS	0105	1203	<b>1,342</b>	ud	50	BOLSA	8431927001221
22011160	PRENSA HSK-K M16 (4/ 8) GRIS	0105	1203	<b>1,353</b>	ud	50	BOLSA	8431927001238
22011161	PRENSA HSK-K M16 (5/10) GRIS	0105	1203	<b>2,387</b>	ud	50	BOLSA	8431927001245
22011200	PRENSA HSK-K M20 (6/12) GRIS	0105	1203	<b>1,848</b>	ud	50	BOLSA	8431927001252
22011201	PRENSA HSK-K M20 (10/14) GRIS	0105	1203	<b>2,750</b>	ud	50	BOLSA	8431927001269
22011250	PRENSA HSK-K M25 (13/18) GRIS	0105	1203	<b>2,937</b>	ud	50	BOLSA	8431927001276
22011320	PRENSA HSK-K M32 (18/25) GRIS	0105	1203	<b>5,764</b>	ud	25	BOLSA	8431927001283
22011400	PRENSA HSK-K M40 (22/32) GRIS	0105	1203	<b>20,911</b>	ud	10	BOLSA	8431927001290
22011500	PRENSA HSK-K M50 (32/38) GRIS	0105	1203	<b>34,969</b>	ud	5	BOLSA	8431927014993
22011630	PRENSA HSK-K M63 (37/44) GRIS	0105	1203	<b>38,489</b>	ud	5	BOLSA	8431927001306

**PRENSAESTOPAS HSK -K Métrica NEGRO IP68 (BAJO PEDIDO, CONSULTAR REFERENCIAS)**



Ref.	Descripción	SERIE	GTV	€/ud	Unidad Venta	Unidad Embala.	Embalaje	Código EAN
22013120	PRENSA HSK-K M12 (3/ 6) NEGR	0105	1203	<b>1,342</b>	ud	50	BOLSA	8431927019813
22013160	PRENSA HSK-K M16 (4/ 8) NEGR	0105	1203	<b>1,353</b>	ud	50	BOLSA	8431927019820
22013161	PRENSA HSK-K M16 (5/10) NEGR	0105	1203	<b>2,387</b>	ud	50	BOLSA	8431927019837
22013200	PRENSA HSK-K M20 (6/12) NEGR	0105	1203	<b>1,848</b>	ud	50	BOLSA	8431927019844
22013201	PRENSA HSK-K M20 (10/14) NEGR	0105	1203	<b>2,750</b>	ud	50	BOLSA	8431927019851
22013250	PRENSA HSK-K M25 (13/18) NEGR	0105	1203	<b>2,937</b>	ud	50	BOLSA	8431927019868
22013320	PRENSA HSK-K M32 (18/25) NEGR	0105	1203	<b>5,764</b>	ud	25	BOLSA	8431927019875
22013400	PRENSA HSK-K M40 (22/32) NEGR	0105	1203	<b>20,911</b>	ud	10	BOLSA	8431927019882
22013500	PRENSA HSK-K M50 (32/38) NEGR	0105	1203	<b>34,969</b>	ud	5	BOLSA	8431927019899
22013630	PRENSA HSK-K M63 (37/44) NEGR	0105	1203	<b>38,489</b>	ud	5	BOLSA	8431927019905

**PRENSAESTOPAS HSK -K ROSCA LARGA PG GRIS IP68 (BAJO PEDIDO, CONSULTAR REFERENCIAS)**



Ref.	Descripción	SERIE	GTV	€/ud	Unidad Venta	Unidad Embala.	Embalaje	Código EAN
22014007	PRENSA HSK-K LARGO PG 7 (3/ 6)	0105	1203	<b>1,540</b>	ud	50	BOLSA	8431927019912
22014009	PRENSA HSK-K LARGO PG 9 (4/ 8)	0105	1203	<b>1,672</b>	ud	50	BOLSA	8431927019929
22014011	PRENSA HSK-K LARGO PG11 (5/10)	0105	1203	<b>2,057</b>	ud	50	BOLSA	8431927019936
22014013	PRENSA HSK-K LARGO PG13 (6/12)	0105	1203	<b>2,277</b>	ud	50	BOLSA	8431927019943
22014016	PRENSA HSK-K LARGO PG16 (10/14)	0105	1203	<b>2,486</b>	ud	50	BOLSA	8431927019950
22014021	PRENSA HSK-K LARGO PG21 (13/18)	0105	1203	<b>3,608</b>	ud	50	BOLSA	8431927019967
22014029	PRENSA HSK-K LARGO PG29 (18/25)	0105	1203	<b>7,106</b>	ud	25	BOLSA	8431927019974
22014036	PRENSA HSK-K LARGO PG36 (22/32)	0105	1203	<b>24,068</b>	ud	10	BOLSA	8431927019981
22014048	PRENSA HSK-K LARGO PG48 (37/44)	0105	1203	<b>44,341</b>	ud	5	BOLSA	8431927019998

**PRENSAESTOPAS HSK -K ROSCA LARGA Métrica GRIS IP68 (BAJO PEDIDO, CONSULTAR REFERENCIAS)**



Ref.	Descripción	SERIE	GTV	€/ud	Unidad Venta	Unidad Embala.	Embalaje	Código EAN
22015120	PRENSA HSK-K LARGO M12 (3/ 6)	0105	1203	<b>1,606</b>	ud	50	BOLSA	8431927020000
22015160	PRENSA HSK-K LARGO M16 (4/ 8)	0105	1203	<b>1,573</b>	ud	50	BOLSA	8431927020017
22015161	PRENSA HSK-K LARGO M16 (5/10)	0105	1203	<b>2,871</b>	ud	50	BOLSA	8431927020024
22015200	PRENSA HSK-K LARGO M20 (6/12)	0105	1203	<b>2,222</b>	ud	50	BOLSA	8431927020031
22015201	PRENSA HSK-K LARGO M20 (10/14)	0105	1203	<b>3,300</b>	ud	50	BOLSA	8431927020048
22015250	PRENSA HSK-K LARGO M25 (13/18)	0105	1203	<b>3,509</b>	ud	50	BOLSA	8431927020055
22015320	PRENSA HSK-K LARGO M32 (18/25)	0105	1203	<b>6,908</b>	ud	25	BOLSA	8431927020062
22015400	PRENSA HSK-K LARGO M40 (22/32)	0105	1203	<b>25,080</b>	ud	10	BOLSA	8431927020079
22015500	PRENSA HSK-K LARGO M50 (32/38)	0105	1203	<b>40,513</b>	ud	5	BOLSA	8431927020086
22015630	PRENSA HSK-K LARGO M63 (37/44)	0105	1203	<b>45,925</b>	ud	5	BOLSA	8431927020093

**PRENSAESTOPAS HSK -M PG IP68**



Ref.	Descripción	SERIE	GTV	€/ud	Unidad Venta	Unidad Embala.	Embalaje	Código EAN
22050007	PRENSA HSK-M PG 7 (3/ 6,5)	0105	1203	<b>5,831</b>	ud	50	BOLSA	8431927001610
22050009	PRENSA HSK-M PG 9 (4/ 8)	0105	1203	<b>6,969</b>	ud	50	BOLSA	8431927001627
22050011	PRENSA HSK-M PG11 (5/10)	0105	1203	<b>8,223</b>	ud	50	BOLSA	8431927001634
22050013	PRENSA HSK-M PG13 (6/12)	0105	1203	<b>9,154</b>	ud	50	BOLSA	8431927001641
22050016	PRENSA HSK-M PG16 (10/14)	0105	1203	<b>10,615</b>	ud	50	BOLSA	8431927001658
22050021	PRENSA HSK-M PG21 (13/18)	0105	1203	<b>17,411</b>	ud	25	BOLSA	8431927001665
22050029	PRENSA HSK-M PG29 (18/25)	0105	1203	<b>28,187</b>	ud	25	BOLSA	8431927001672
22050036	PRENSA HSK-M PG36 (22/32)	0105	1203	<b>51,888</b>	ud	10	BOLSA	8431927001689
22050048	PRENSA HSK-M PG48 (37/44)	0105	1203	<b>123,568</b>	ud	5	BOLSA	8431927001696

**PRENSAESTOPAS HSK -M Métrica IP68**



Ref.	Descripción	SERIE	GTV	€/ud	Unidad Venta	Unidad Embala.	Embalaje	Código EAN
22051120	PRENSA HSK-M M12 (3/ 6,5)	0105	1203	<b>6,314</b>	ud	50	BOLSA	8431927001702
22051160	PRENSA HSK-M M16 (4/ 8)	0105	1203	<b>6,659</b>	ud	50	BOLSA	8431927001719
22051161	PRENSA HSK-M M16 (5/10)	0105	1203	<b>12,466</b>	ud	50	BOLSA	8431927001726
22051200	PRENSA HSK-M M20 (6/12)	0105	1203	<b>8,729</b>	ud	50	BOLSA	8431927001733
22051201	PRENSA HSK-M M20 (10/14)	0105	1203	<b>17,262</b>	ud	50	BOLSA	8431927001740
22051250	PRENSA HSK-M M25 (13/18)	0105	1203	<b>16,618</b>	ud	25	BOLSA	8431927001757
22051320	PRENSA HSK-M M32 (18/25)	0105	1203	<b>26,876</b>	ud	25	BOLSA	8431927001764
22051400	PRENSA HSK-M M40 (22/32)	0105	1203	<b>49,542</b>	ud	10	BOLSA	8431927001771
22051500	PRENSA HSK-M M50 (32/38)	0105	1203	<b>97,290</b>	ud	5	BOLSA	8431927015013
22051630	PRENSA HSK-M M63 (37/44)	0105	1203	<b>117,921</b>	ud	5	BOLSA	8431927001788

**PRENSAESTOPAS HSK -MZ Métrica IP68 (BAJO PEDIDO, CONSULTAR REFERENCIAS)**



Ref.	Descripción	SERIE	GTV	€/ud	Unidad Venta	Unidad Embala.	Embalaje	Código EAN
22060120	PRENSA HSK-MZ M12 (3/ 6)	0105	1203	<b>9,396</b>	ud	50	BOLSA	8431927020109
22060160	PRENSA HSK-MZ M16 (6/ 8)	0105	1203	<b>10,638</b>	ud	50	BOLSA	8431927020116
22060161	PRENSA HSK-MZ M16 (6/10)	0105	1203	<b>15,583</b>	ud	50	BOLSA	8431927020123
22060200	PRENSA HSK-MZ M20 (6/12)	0105	1203	<b>13,513</b>	ud	50	BOLSA	8431927020130
22060201	PRENSA HSK-MZ M20 (10/14)	0105	1203	<b>23,138</b>	ud	50	BOLSA	8431927020147
22060250	PRENSA HSK-MZ M25 (13/18)	0105	1203	<b>36,846</b>	ud	25	BOLSA	8431927020154
22060320	PRENSA HSK-MZ M32 (18/25)	0105	1203	<b>65,504</b>	ud	25	BOLSA	8431927020161
22060400	PRENSA HSK-MZ M40 (22/32)	0105	1203	<b>89,765</b>	ud	10	BOLSA	8431927020178
22060500	PRENSA HSK-MZ M50 (32/38)	0105	1203	<b>167,225</b>	ud	5	BOLSA	8431927020185
22060501	PRENSA HSK-MZ M50 (25/31)	0105	1203	<b>167,225</b>	ud	5	BOLSA	8431927020192
22060630	PRENSA HSK-MZ M63 (37/44)	0105	1203	<b>211,225</b>	ud	5	BOLSA	8431927020208
22060631	PRENSA HSK-MZ M63 (29/35)	0105	1203	<b>211,225</b>	ud	5	BOLSA	8431927020215

**PRENSAESTOPAS HSK -INOX Métrica IP68 (BAJO PEDIDO, CONSULTAR REFERENCIAS)**



Ref.	Descripción	SERIE	GTV	€/ud	Unidad Venta	Unidad Embala.	Embalaje	Código EAN
22070120	PRENSA HSK-INOX M12 (3/ 6)	0105	1203	<b>consultar</b>	ud	10	BOLSA	8431927020222
22070160	PRENSA HSK-INOX M16 (5/10)	0105	1203	<b>consultar</b>	ud	10	BOLSA	8431927020239
22070200	PRENSA HSK-INOX M20 (10/14)	0105	1203	<b>consultar</b>	ud	10	BOLSA	8431927020246
22070250	PRENSA HSK-INOX M25 (13/18)	0105	1203	<b>consultar</b>	ud	10	BOLSA	8431927020253
22070320	PRENSA HSK-INOX M32 (18/25)	0105	1203	<b>consultar</b>	ud	5	BOLSA	8431927020260
22070400	PRENSA HSK-INOX M40 (22/32)	0105	1203	<b>consultar</b>	ud	5	BOLSA	8431927020277

**PRENSAESTOPAS HSK -INOX-HD Métrica IP68 (BAJO PEDIDO, CONSULTAR REFERENCIAS)**



Ref.	Descripción	SERIE	GTV	€/ud	Unidad Venta	Unidad Embala.	Embalaje	Código EAN
22040120	PRENSA HSK-INOX-HD M12 (3/ 6,5)	0105	1203	<b>consultar</b>	ud	10	BOLSA	8431927090829
22040160	PRENSA HSK-INOX-HD M16 (5/10)	0105	1203	<b>consultar</b>	ud	10	BOLSA	8431927090836
22040200	PRENSA HSK-INOX-HD M20 (10/14)	0105	1203	<b>consultar</b>	ud	5	BOLSA	8431927090843
22040250	PRENSA HSK-INOX-HD M25 (13/18)	0105	1203	<b>consultar</b>	ud	5	BOLSA	8431927090850

**PRENSAESTOPAS HSK -K -Ex PG IP68 (BAJO PEDIDO, CONSULTAR REFERENCIAS)**



Ref.	Descripción	SERIE	GTV	€/ud	Unidad Venta	Unidad Embala.	Embalaje	Código EAN
22030007	PRENSA HSK-K-EX PG 7 (3/ 6,5)	0105	1203	<b>5,865</b>	ud	50	BOLSA	8431927001436
22030009	PRENSA HSK-K-EX PG 9 (4/ 8)	0105	1203	<b>5,925</b>	ud	50	BOLSA	8431927001443
22030011	PRENSA HSK-K-EX PG11 (5/10)	0105	1203	<b>6,345</b>	ud	50	BOLSA	8431927001450
22030013	PRENSA HSK-K-EX PG13 (6,5/12)	0105	1203	<b>6,558</b>	ud	50	BOLSA	8431927001467
22030016	PRENSA HSK-K-EX PG16 (10/14)	0105	1203	<b>6,558</b>	ud	50	BOLSA	8431927001474
22030021	PRENSA HSK-K-EX PG21 (13/18)	0105	1203	<b>8,427</b>	ud	50	BOLSA	8431927001481
22030029	PRENSA HSK-K-EX PG29 (18/25)	0105	1203	<b>16,201</b>	ud	25	BOLSA	8431927001498
22030036	PRENSA HSK-K-EX PG36 (22/32)	0105	1203	<b>31,142</b>	ud	10	BOLSA	8431927001504
22030048	PRENSA HSK-K-EX PG48 (37/44)	0105	1203	<b>90,625</b>	ud	5	BOLSA	8431927001511



**PRENSAESTOPAS HSK -K -Ex Métrica IP68 (BAJO PEDIDO, CONSULTAR REFERENCIAS)**



Ref.	Descripción	SERIE	GTV	€/ud	Unidad Venta	Unidad Embala.	Embalaje	Código EAN
22031120	PRENSA HSK-K-EX M12 (3/ 6,5)	0105	1203	<b>5,727</b>	ud	50	BOLSA	8431927001528
22031160	PRENSA HSK-K-EX M16 (4/ 8)	0105	1203	<b>6,187</b>	ud	50	BOLSA	8431927001535
22031161	PRENSA HSK-K-EX M16 (5/10)	0105	1203	<b>6,659</b>	ud	50	BOLSA	8431927001542
22031200	PRENSA HSK-K-EX M20 (6,5/12)	0105	1203	<b>6,669</b>	ud	50	BOLSA	8431927001559
22031201	PRENSA HSK-K-EX M20 (10/14)	0105	1203	<b>7,211</b>	ud	50	BOLSA	8431927001566
22031250	PRENSA HSK-K-EX M25 (13/18)	0105	1203	<b>8,188</b>	ud	50	BOLSA	8431927001573
22031320	PRENSA HSK-K-EX M32 (18/25)	0105	1203	<b>15,755</b>	ud	25	BOLSA	8431927001580
22031400	PRENSA HSK-K-EX M40 (22/32)	0105	1203	<b>30,268</b>	ud	10	BOLSA	8431927001597
22031500	PRENSA HSK-K-EX M50 (32/38)	0105	1203	<b>53,165</b>	ud	5	BOLSA	8431927015006
22031630	PRENSA HSK-K-EX M63 (37/44)	0105	1203	<b>88,148</b>	ud	5	BOLSA	8431927001603

**PRENSAESTOPAS HSK -M -Ex PG IP68 (BAJO PEDIDO, CONSULTAR REFERENCIAS)**



Ref.	Descripción	SERIE	GTV	€/ud	Unidad Venta	Unidad Embala.	Embalaje	Código EAN
22080007	PRENSA HSK-M-EX PG 7 (3/ 6)	0105	1203	<b>10,597</b>	ud	50	BOLSA	8431927020284
22080009	PRENSA HSK-M-EX PG 9 (4/ 8)	0105	1203	<b>11,551</b>	ud	50	BOLSA	8431927020291
22080011	PRENSA HSK-M-EX PG11 (6/10)	0105	1203	<b>12,885</b>	ud	50	BOLSA	8431927020307
22080013	PRENSA HSK-M-EX PG13 (6/12)	0105	1203	<b>13,657</b>	ud	50	BOLSA	8431927020314
22080016	PRENSA HSK-M-EX PG16 (10/14)	0105	1203	<b>14,837</b>	ud	50	BOLSA	8431927020321
22080021	PRENSA HSK-M-EX PG21 (14/18)	0105	1203	<b>21,055</b>	ud	25	BOLSA	8431927020338
22080029	PRENSA HSK-M-EX PG29 (20/25)	0105	1203	<b>32,514</b>	ud	25	BOLSA	8431927020345
22080036	PRENSA HSK-M-EX PG36 (22/32)	0105	1203	<b>52,119</b>	ud	10	BOLSA	8431927020352
22080048	PRENSA HSK-M-EX PG48 (37/44)	0105	1203	<b>117,674</b>	ud	5	BOLSA	8431927020369

**PRENSAESTOPAS HSK -M -Ex Métrica IP68 (BAJO PEDIDO, CONSULTAR REFERENCIAS)**



Ref.	Descripción	SERIE	GTV	€/ud	Unidad Venta	Unidad Embala.	Embalaje	Código EAN
22081120	PRENSA HSK-M-EX M12 (3/ 6)	0105	1203	<b>10,109</b>	ud	50	BOLSA	8431927020376
22081160	PRENSA HSK-M-EX M16 (4/ 8)	0105	1203	<b>11,064</b>	ud	50	BOLSA	8431927020383
22081161	PRENSA HSK-M-EX M16 (6/10)	0105	1203	<b>14,595</b>	ud	50	BOLSA	8431927020390
22081200	PRENSA HSK-M-EX M20 (6/12)	0105	1203	<b>14,042</b>	ud	50	BOLSA	8431927020406
22081201	PRENSA HSK-M-EX M20 (10/14)	0105	1203	<b>14,865</b>	ud	50	BOLSA	8431927020413
22081250	PRENSA HSK-M-EX M25 (14/18)	0105	1203	<b>20,459</b>	ud	25	BOLSA	8431927020420
22081320	PRENSA HSK-M-EX M32 (20/25)	0105	1203	<b>31,591</b>	ud	25	BOLSA	8431927020437
22081400	PRENSA HSK-M-EX M40 (22/32)	0105	1203	<b>52,145</b>	ud	10	BOLSA	8431927020444
22081500	PRENSA HSK-M-EX M50 (32/38)	0105	1203	<b>100,144</b>	ud	5	BOLSA	8431927020451
22081630	PRENSA HSK-M-EX M63 (37/44)	0105	1203	<b>121,142</b>	ud	5	BOLSA	8431927020468

**PRENSAESTOPAS HSK -M -EMV -D Métrica IP68 (BAJO PEDIDO, CONSULTAR REFERENCIAS)**



Ref.	Descripción	SERIE	GTV	€/ud	Unidad Venta	Unidad Embala.	Embalaje	Código EAN
22090120	PRENSA HSK-M-EMV-D M12 (3/ 6)	0105	1203	<b>14,881</b>	ud	50	BOLSA	8431927020475
22090160	PRENSA HSK-M-EMV-D M16 (5/10)	0105	1203	<b>26,588</b>	ud	50	BOLSA	8431927020482
22090200	PRENSA HSK-M-EMV-D M20 (10/14)	0105	1203	<b>30,878</b>	ud	50	BOLSA	8431927020499
22090250	PRENSA HSK-M-EMV-D M25 (13/18)	0105	1203	<b>45,172</b>	ud	25	BOLSA	8431927020505
22090320	PRENSA HSK-M-EMV-D M32 (18/25)	0105	1203	<b>70,967</b>	ud	25	BOLSA	8431927020512
22090400	PRENSA HSK-M-EMV-D M40 (24/32)	0105	1203	<b>145,728</b>	ud	10	BOLSA	8431927020529
22090500	PRENSA HSK-M-EMV-D M50 (32/38)	0105	1203	<b>183,678</b>	ud	5	BOLSA	8431927020536
22090630	PRENSA HSK-M-EMV-D M63 (37/44)	0105	1203	<b>234,209</b>	ud	5	BOLSA	8431927020543

**PRENSAESTOPAS HSK -FLEX Métrica IP68**



Ref.	Descripción	SERIE	GTV	€/ud	Unidad Venta	Unidad Embala.	Embalaje	Código EAN
22020007	PRENSA HSK-FLEX PG 7 (3/ 6)	0105	1203	<b>2,321</b>	ud	50	BOLSA	8431927001313
22020009	PRENSA HSK-FLEX PG 9 (4/ 8)	0105	1203	<b>2,552</b>	ud	50	BOLSA	8431927001320
22020011	PRENSA HSK-FLEX PG11 (5/10)	0105	1203	<b>2,982</b>	ud	50	BOLSA	8431927001337
22020013	PRENSA HSK-FLEX PG13 (6/12)	0105	1203	<b>3,255</b>	ud	50	BOLSA	8431927001344
22020016	PRENSA HSK-FLEX PG16 (10/14)	0105	1203	<b>3,591</b>	ud	25	BOLSA	8431927001351
22020021	PRENSA HSK-FLEX PG21 (13/18)	0105	1203	<b>6,657</b>	ud	20	BOLSA	8431927001368

**PRENSAESTOPA HSK -FLEX Métrica IP68**



Ref.	Descripción	SERIE	GTV	€/ud	Unidad Venta	Unidad Embala.	Embalaje	Código EAN
22021120	PRENSA HSK-FLEX M12 (3/ 6)	0105	1203	<b>2,216</b>	ud	50	BOLSA	8431927001375
22021160	PRENSA HSK-FLEX M16 (4/ 8)	0105	1203	<b>2,436</b>	ud	50	BOLSA	8431927001382
22021161	PRENSA HSK-FLEX M16 (5/10)	0105	1203	<b>3,590</b>	ud	50	BOLSA	8431927001399
22021200	PRENSA HSK-FLEX M20 (6/12)	0105	1203	<b>4,326</b>	ud	50	BOLSA	8431927001405
22021201	PRENSA HSK-FLEX M20 (10/14)	0105	1203	<b>4,326</b>	ud	25	BOLSA	8431927001412
22021250	PRENSA HSK-FLEX M25 (13/18)	0105	1203	<b>6,363</b>	ud	20	BOLSA	8431927001429

# ACCESORIOS

## TUERCA TCP PG GRIS



Ref.	Descripción	SERIE	GTV	€/ud	Unidad Venta	Unidad Embala.	Embalaje	Código EAN
40020007	TUERCA TCP GRIS PG 7	0105	1301	<b>0,140</b>	ud	100	BOLSA	8431927005632
40020009	TUERCA TCP GRIS PG 9	0105	1301	<b>0,144</b>	ud	100	BOLSA	8431927005649
40020011	TUERCA TCP GRIS PG11	0105	1301	<b>0,157</b>	ud	100	BOLSA	8431927005656
40020013	TUERCA TCP GRIS PG13	0105	1301	<b>0,187</b>	ud	100	BOLSA	8431927005663
40020016	TUERCA TCP GRIS PG16	0105	1301	<b>0,223</b>	ud	100	BOLSA	8431927005670
40020021	TUERCA TCP GRIS PG21	0105	1301	<b>0,362</b>	ud	100	BOLSA	8431927005687
40020029	TUERCA TCP GRIS PG29	0105	1301	<b>0,552</b>	ud	50	BOLSA	8431927005694
40020036	TUERCA TCP GRIS PG36	0105	1301	<b>0,932</b>	ud	25	BOLSA	8431927005700
40020042	TUERCA TCP GRIS PG42	0105	1301	<b>1,648</b>	ud	25	BOLSA	8431927019240
40020048	TUERCA TCP GRIS PG48	0105	1301	<b>2,092</b>	ud	25	BOLSA	8431927005717

## TUERCA TCP PG GRIS OSCURO



Ref.	Descripción	SERIE	GTV	€/ud	Unidad Venta	Unidad Embala.	Embalaje	Código EAN
40026007	TUERCA TCP PG 7 GRIS OSCURO	0105	1301	<b>0,140</b>	ud	100	BOLSA	8431927042255
40026009	TUERCA TCP PG 9 GRIS OSCURO	0105	1301	<b>0,144</b>	ud	100	BOLSA	8431927042262
40026011	TUERCA TCP PG11 GRIS OSCURO	0105	1301	<b>0,157</b>	ud	100	BOLSA	8431927042279
40026013	TUERCA TCP PG13 GRIS OSCURO	0105	1301	<b>0,187</b>	ud	100	BOLSA	8431927042286
40026016	TUERCA TCP PG16 GRIS OSCURO	0105	1301	<b>0,223</b>	ud	100	BOLSA	8431927042293
40026021	TUERCA TCP PG21 GRIS OSCURO	0105	1301	<b>0,362</b>	ud	100	BOLSA	8431927042309
40026029	TUERCA TCP PG29 GRIS OSCURO	0105	1301	<b>0,552</b>	ud	50	BOLSA	8431927042316
40026036	TUERCA TCP PG36 GRIS OSCURO	0105	1301	<b>0,932</b>	ud	25	BOLSA	8431927042323
40026042	TUERCA TCP PG42 GRIS OSCURO	0105	1301	<b>1,648</b>	ud	25	BOLSA	8431927042330
40026048	TUERCA TCP PG48 GRIS OSCURO	0105	1301	<b>2,092</b>	ud	25	BOLSA	8431927042347

## TUERCA TCP PG NEGRO



Ref.	Descripción	SERIE	GTV	€/ud	Unidad Venta	Unidad Embala.	Embalaje	Código EAN
40024007	TUERCA TCP NEGR PG 7	0105	1301	<b>0,140</b>	ud	100	BOLSA	8431927020550
40024009	TUERCA TCP NEGR PG 9	0105	1301	<b>0,144</b>	ud	100	BOLSA	8431927020567
40024011	TUERCA TCP NEGR PG11	0105	1301	<b>0,157</b>	ud	100	BOLSA	8431927020574
40024013	TUERCA TCP NEGR PG13	0105	1301	<b>0,187</b>	ud	100	BOLSA	8431927020581
40024016	TUERCA TCP NEGR PG16	0105	1301	<b>0,223</b>	ud	100	BOLSA	8431927020598
40024021	TUERCA TCP NEGR PG21	0105	1301	<b>0,362</b>	ud	100	BOLSA	8431927020604
40024029	TUERCA TCP NEGR PG29	0105	1301	<b>0,552</b>	ud	50	BOLSA	8431927020611
40024036	TUERCA TCP NEGR PG36	0105	1301	<b>0,932</b>	ud	25	BOLSA	8431927020628
40024048	TUERCA TCP NEGR PG48	0105	1301	<b>2,092</b>	ud	25	BOLSA	8431927020635

## TUERCA TCP Métrica GRIS



Ref.	Descripción	SERIE	GTV	€/ud	Unidad Venta	Unidad Embala.	Embalaje	Código EAN
40021120	TUERCA TCP GRIS M12	0105	1301	<b>0,158</b>	ud	100	BOLSA	8431927005724
40021160	TUERCA TCP GRIS M16	0105	1301	<b>0,173</b>	ud	100	BOLSA	8431927005731
40021200	TUERCA TCP GRIS M20	0105	1301	<b>0,232</b>	ud	100	BOLSA	8431927005748
40021250	TUERCA TCP GRIS M25	0105	1301	<b>0,380</b>	ud	100	BOLSA	8431927005755
40021320	TUERCA TCP GRIS M32	0105	1301	<b>0,571</b>	ud	50	BOLSA	8431927005762
40021400	TUERCA TCP GRIS M40	0105	1301	<b>1,047</b>	ud	25	BOLSA	8431927005779
40021500	TUERCA TCP GRIS M50	0105	1301	<b>1,706</b>	ud	25	BOLSA	8431927005786
40021630	TUERCA TCP GRIS M63	0105	1301	<b>2,620</b>	ud	25	BOLSA	8431927005793

## TUERCA TCP Métrica GRIS OSCURO



Ref.	Descripción	SERIE	GTV	€/ud	Unidad Venta	Unidad Embala.	Embalaje	Código EAN
40027120	TUERCA TCP M12 GRIS OSCURO	0105	1301	<b>0,158</b>	ud	100	BOLSA	8431927042354
40027160	TUERCA TCP M16 GRIS OSCURO	0105	1301	<b>0,173</b>	ud	100	BOLSA	8431927042361
40027200	TUERCA TCP M20 GRIS OSCURO	0105	1301	<b>0,232</b>	ud	100	BOLSA	8431927042378
40027250	TUERCA TCP M25 GRIS OSCURO	0105	1301	<b>0,380</b>	ud	100	BOLSA	8431927042385
40027320	TUERCA TCP M32 GRIS OSCURO	0105	1301	<b>0,571</b>	ud	50	BOLSA	8431927042392
40027400	TUERCA TCP M40 GRIS OSCURO	0105	1301	<b>1,047</b>	ud	25	BOLSA	8431927042408
40027500	TUERCA TCP M50 GRIS OSCURO	0105	1301	<b>1,706</b>	ud	25	BOLSA	8431927042415
40027630	TUERCA TCP M63 GRIS OSCURO	0105	1301	<b>2,620</b>	ud	25	BOLSA	8431927042422

**TUERCA TCP Métrica NEGRO**

Ref.	Descripción	SERIE	GTV	€/ud	Unidad Venta	Unidad Embala.	Embalaje	Código EAN
40025120	TUERCA TCP NEGR M12	0105	1301	<b>0,158</b>	ud	100	BOLSA	8431927020642
40025160	TUERCA TCP NEGR M16	0105	1301	<b>0,173</b>	ud	100	BOLSA	8431927020659
40025200	TUERCA TCP NEGR M20	0105	1301	<b>0,232</b>	ud	100	BOLSA	8431927020666
40025250	TUERCA TCP NEGR M25	0105	1301	<b>0,380</b>	ud	100	BOLSA	8431927020673
40025320	TUERCA TCP NEGR M32	0105	1301	<b>0,571</b>	ud	50	BOLSA	8431927020680
40025400	TUERCA TCP NEGR M40	0105	1301	<b>1,047</b>	ud	25	BOLSA	8431927020697
40025500	TUERCA TCP NEGR M50	0105	1301	<b>1,706</b>	ud	25	BOLSA	8431927020703
40025630	TUERCA TCP NEGR M63	0105	1301	<b>2,620</b>	ud	25	BOLSA	8431927020710

**TUERCA TCM PG**

Ref.	Descripción	SERIE	GTV	€/ud	Unidad Venta	Unidad Embala.	Embalaje	Código EAN
40010007	TUERCA TCM PG 7	0105	1301	<b>0,214</b>	ud	100	BOLSA	8431927005465
40010009	TUERCA TCM PG 9	0105	1301	<b>0,259</b>	ud	100	BOLSA	8431927005472
40010011	TUERCA TCM PG11	0105	1301	<b>0,299</b>	ud	100	BOLSA	8431927005489
40010013	TUERCA TCM PG13	0105	1301	<b>0,334</b>	ud	100	BOLSA	8431927005496
40010016	TUERCA TCM PG16	0105	1301	<b>0,414</b>	ud	100	BOLSA	8431927005502
40010021	TUERCA TCM PG21	0105	1301	<b>0,699</b>	ud	100	BOLSA	8431927005519
40010029	TUERCA TCM PG29	0105	1301	<b>0,999</b>	ud	50	BOLSA	8431927005526
40010036	TUERCA TCM PG36	0105	1301	<b>2,019</b>	ud	25	BOLSA	8431927005533
40010042	TUERCA TCM PG42	0105	1301	<b>2,853</b>	ud	25	BOLSA	8431927021953
40010048	TUERCA TCM PG48	0105	1301	<b>3,687</b>	ud	25	BOLSA	8431927005540

**TUERCA TCM Métrica**

Ref.	Descripción	SERIE	GTV	€/ud	Unidad Venta	Unidad Embala.	Embalaje	Código EAN
40011120	TUERCA TCM M12	0105	1301	<b>0,225</b>	ud	100	BOLSA	8431927005557
40011160	TUERCA TCM M16	0105	1301	<b>0,307</b>	ud	100	BOLSA	8431927005564
40011200	TUERCA TCM M20	0105	1301	<b>0,418</b>	ud	100	BOLSA	8431927005571
40011250	TUERCA TCM M25	0105	1301	<b>0,658</b>	ud	100	BOLSA	8431927005588
40011320	TUERCA TCM M32	0105	1301	<b>0,953</b>	ud	50	BOLSA	8431927005595
40011400	TUERCA TCM M40	0105	1301	<b>1,592</b>	ud	25	BOLSA	8431927005601
40011500	TUERCA TCM M50	0105	1301	<b>2,938</b>	ud	25	BOLSA	8431927005618
40011630	TUERCA TCM M63	0105	1301	<b>4,935</b>	ud	25	BOLSA	8431927005625

**TUERCA TCM INOX PG**

Ref.	Descripción	SERIE	GTV	€/ud	Unidad Venta	Unidad Embala.	Embalaje	Código EAN
40015007	TUERCA TCM INOX PG 7	0105	1301	consultar	ud	100	BOLSA	8431927100498
40015009	TUERCA TCM INOX PG 9	0105	1301	consultar	ud	50	BOLSA	8431927100504
40015011	TUERCA TCM INOX PG11	0105	1301	consultar	ud	50	BOLSA	8431927100511
40015013	TUERCA TCM INOX PG13	0105	1301	consultar	ud	50	BOLSA	8431927100528
40015016	TUERCA TCM INOX PG16	0105	1301	consultar	ud	50	BOLSA	8431927100535
40015021	TUERCA TCM INOX PG21	0105	1301	consultar	ud	25	BOLSA	8431927100542
40015029	TUERCA TCM INOX PG29	0105	1301	consultar	ud	20	BOLSA	8431927100559
40015036	TUERCA TCM INOX PG36	0105	1301	consultar	ud	10	BOLSA	8431927100566
40015042	TUERCA TCM INOX PG42	0105	1301	consultar	ud	5	BOLSA	8431927100573
40015048	TUERCA TCM INOX PG48	0105	1301	consultar	ud	5	BOLSA	8431927100580

**TUERCA TCM INOX Métrica**

Ref.	Descripción	SERIE	GTV	€/ud	Unidad Venta	Unidad Embala.	Embalaje	Código EAN
40014160	TUERCA TCM INOX M16	0105	1301	consultar	ud	50	BOLSA	8431927020727
40014200	TUERCA TCM INOX M20	0105	1301	consultar	ud	50	BOLSA	8431927020734
40014250	TUERCA TCM INOX M25	0105	1301	consultar	ud	25	BOLSA	8431927020741
40014320	TUERCA TCM INOX M32	0105	1301	consultar	ud	25	BOLSA	8431927020758
40014400	TUERCA TCM INOX M40	0105	1301	consultar	ud	10	BOLSA	8431927020765
40014500	TUERCA TCM INOX M50	0105	1301	consultar	ud	10	BOLSA	8431927020772
40014630	TUERCA TCM INOX M63	0105	1301	consultar	ud	10	BOLSA	8431927020789

**TUERCA TCM ECM PG**

Ref.	Descripción	SERIE	GTV	€/ud	Unidad Venta	Unidad Embala.	Embalaje	Código EAN
40016007	TUERCA EMC PG 7	0105	1301	<b>1,028</b>	ud	100	BOLSA	8431927100597
40016009	TUERCA EMC PG 9	0105	1301	<b>1,167</b>	ud	50	BOLSA	8431927100603
40016011	TUERCA EMC PG11	0105	1301	<b>1,260</b>	ud	50	BOLSA	8431927100610
40016013	TUERCA EMC PG13	0105	1301	<b>1,335</b>	ud	50	BOLSA	8431927100627
40016016	TUERCA EMC PG16	0105	1301	<b>1,478</b>	ud	50	BOLSA	8431927100634
40016021	TUERCA EMC PG21	0105	1301	<b>2,016</b>	ud	25	BOLSA	8431927100641
40016029	TUERCA EMC PG29	0105	1301	<b>2,626</b>	ud	20	BOLSA	8431927100658
40016036	TUERCA EMC PG36	0105	1301	<b>3,828</b>	ud	10	BOLSA	8431927100665
40016042	TUERCA EMC PG42	0105	1301	<b>6,202</b>	ud	5	BOLSA	8431927100672
40016048	TUERCA EMC PG48	0105	1301	<b>6,557</b>	ud	5	BOLSA	8431927100689

**TUERCA TCM ECM Métrica**

Ref.	Descripción	SERIE	GTV	€/ud	Unidad Venta	Unidad Embala.	Embalaje	Código EAN
40017120	TUERCA EMC M12	0105	1301	<b>1,294</b>	ud	100	BOLSA	8431927100696
40017160	TUERCA EMC M16	0105	1301	<b>1,339</b>	ud	50	BOLSA	8431927100702
40017200	TUERCA EMC M20	0105	1301	<b>1,416</b>	ud	50	BOLSA	8431927100719
40017250	TUERCA EMC M25	0105	1301	<b>2,320</b>	ud	25	BOLSA	8431927100726
40017320	TUERCA EMC M32	0105	1301	<b>3,703</b>	ud	20	BOLSA	8431927100733
40017400	TUERCA EMC M40	0105	1301	<b>5,131</b>	ud	10	BOLSA	8431927100740
40017500	TUERCA EMC M50	0105	1301	<b>13,206</b>	ud	5	BOLSA	8431927100757
40017630	TUERCA EMC M63	0105	1301	<b>15,036</b>	ud	5	BOLSA	8431927100764

**JUNTA PLANA PG**

Ref.	Descripción	SERIE	GTV	€/ud	Unidad Venta	Unidad Embala.	Embalaje	Código EAN
39090007	JUNTA PLANA PG 7	0105	1301	<b>0,240</b>	ud	500	BOLSA	8431927021335
39090009	JUNTA PLANA PG 9	0105	1301	<b>0,257</b>	ud	500	BOLSA	8431927021342
39090011	JUNTA PLANA PG11	0105	1301	<b>0,266</b>	ud	500	BOLSA	8431927021359
39090013	JUNTA PLANA PG13	0105	1301	<b>0,331</b>	ud	500	BOLSA	8431927021366
39090016	JUNTA PLANA PG16	0105	1301	<b>0,363</b>	ud	500	BOLSA	8431927021373
39090021	JUNTA PLANA PG21	0105	1301	<b>0,442</b>	ud	500	BOLSA	8431927021380
39090029	JUNTA PLANA PG29	0105	1301	<b>0,735</b>	ud	250	BOLSA	8431927021328
39090036	JUNTA PLANA PG36	0105	1301	<b>0,957</b>	ud	100	BOLSA	8431927021397
39090048	JUNTA PLANA PG48	0105	1301	<b>1,463</b>	ud	50	BOLSA	8431927021403

**JUNTA PLANA Métrica**

Ref.	Descripción	SERIE	GTV	€/ud	Unidad Venta	Unidad Embala.	Embalaje	Código EAN
39090112	JUNTA PLANA M12	0105	1301	<b>0,288</b>	ud	500	BOLSA	8431927021410
39090116	JUNTA PLANA M16	0105	1301	<b>0,299</b>	ud	500	BOLSA	8431927021427
39090120	JUNTA PLANA M20	0105	1301	<b>0,338</b>	ud	500	BOLSA	8431927021434
39090125	JUNTA PLANA M25	0105	1301	<b>0,461</b>	ud	500	BOLSA	8431927021441
39090132	JUNTA PLANA M32	0105	1301	<b>0,681</b>	ud	250	BOLSA	8431927021458
39090140	JUNTA PLANA M40	0105	1301	<b>1,044</b>	ud	100	BOLSA	8431927021465
39090150	JUNTA PLANA M50	0105	1301	<b>1,388</b>	ud	50	BOLSA	8431927021472
39090163	JUNTA PLANA M63	0105	1301	<b>2,162</b>	ud	50	BOLSA	8431927021489

**JUNTA TORICA PG**

Ref.	Descripción	SERIE	GTV	€/ud	Unidad Venta	Unidad Embala.	Embalaje	Código EAN
39096007	JUNTA TORICA PG 7	0105	1301	<b>0,204</b>	ud	500	BOLSA	8431927021496
39096009	JUNTA TORICA PG 9	0105	1301	<b>0,246</b>	ud	500	BOLSA	8431927021502
39096011	JUNTA TORICA PG11	0105	1301	<b>0,261</b>	ud	500	BOLSA	8431927021519
39096013	JUNTA TORICA PG13	0105	1301	<b>0,380</b>	ud	500	BOLSA	8431927021526
39096016	JUNTA TORICA PG16	0105	1301	<b>0,403</b>	ud	500	BOLSA	8431927021533
39096021	JUNTA TORICA PG21	0105	1301	<b>0,472</b>	ud	500	BOLSA	8431927021540
39096029	JUNTA TORICA PG29	0105	1301	<b>0,610</b>	ud	250	BOLSA	8431927021557
39096036	JUNTA TORICA PG36	0105	1301	<b>0,796</b>	ud	100	BOLSA	8431927021564
39096048	JUNTA TORICA PG48	0105	1301	<b>1,162</b>	ud	50	BOLSA	8431927021571

**JUNTA TORICA Métrica**

Ref.	Descripción	SERIE	GTV	€/ud	Unidad Venta	Unidad Embala.	Embalaje	Código EAN
39096112	JUNTA TORICA M12	0105	1301	<b>0,260</b>	ud	500	BOLSA	8431927021588
39096116	JUNTA TORICA M16	0105	1301	<b>0,300</b>	ud	500	BOLSA	8431927021595
39096120	JUNTA TORICA M20	0105	1301	<b>0,450</b>	ud	500	BOLSA	8431927021601
39096125	JUNTA TORICA M25	0105	1301	<b>0,550</b>	ud	500	BOLSA	8431927021618
39096132	JUNTA TORICA M32	0105	1301	<b>0,700</b>	ud	250	BOLSA	8431927021625
39096140	JUNTA TORICA M40	0105	1301	<b>1,089</b>	ud	50	BOLSA	8431927021632
39096150	JUNTA TORICA M50	0105	1301	<b>0,990</b>	ud	50	BOLSA	8431927021649
39096163	JUNTA TORICA M63	0105	1301	<b>1,474</b>	ud	50	BOLSA	8431927021656

**REDUCCION R-H Métrica-Métrica**

Ref.	Descripción	SERIE	GTV	€/ud	Unidad Venta	Unidad Embala.	Embalaje	Código EAN
42001612	REDUCCION M16 M12	0105	1301	<b>0,840</b>	ud	100	BOLSA	8431927020949
42002016	REDUCCION M20 M16	0105	1301	<b>1,116</b>	ud	100	BOLSA	8431927020963
42002516	REDUCCION M25 M16	0105	1301	<b>2,737</b>	ud	50	BOLSA	8431927020970
42002520	REDUCCION M25 M20	0105	1301	<b>1,955</b>	ud	50	BOLSA	8431927020987
42003220	REDUCCION M32 M20	0105	1301	<b>4,957</b>	ud	50	BOLSA	8431927020994
42003225	REDUCCION M32 M25	0105	1301	<b>3,197</b>	ud	50	BOLSA	8431927021007
42004025	REDUCCION M40 M25	0105	1301	<b>7,716</b>	ud	25	BOLSA	8431927021014
42004032	REDUCCION M40 M32	0105	1301	<b>5,187</b>	ud	25	BOLSA	8431927021021
42005032	REDUCCION M50 M32	0105	1301	<b>10,188</b>	ud	10	BOLSA	8431927021038

**AMPLIACIÓN E-MS PG-PG**

Ref.	Descripción	SERIE	GTV	€/ud	Unidad Venta	Unidad Embala.	Embalaje	Código EAN
42020709	AMPLIACION E- MS PG 7 PG 9	0105	1301	<b>1,102</b>	ud	100	BOLSA	8431927005946
42020911	AMPLIACION E- MS PG 9 PG11	0105	1301	<b>1,375</b>	ud	100	BOLSA	8431927005953
42020913	AMPLIACION E- MS PG 9 PG13	0105	1301	<b>1,448</b>	ud	100	BOLSA	8431927005960
42021113	AMPLIACION E- MS PG11 PG13	0105	1301	<b>1,541</b>	ud	100	BOLSA	8431927005977
42021116	AMPLIACION E- MS PG11 PG16	0105	1301	<b>1,882</b>	ud	100	BOLSA	8431927005984
42021316	AMPLIACION E- MS PG13 PG16	0105	1301	<b>1,767</b>	ud	100	BOLSA	8431927005991
42021621	AMPLIACION E- MS PG16 PG21	0105	1301	<b>3,317</b>	ud	50	BOLSA	8431927006004
42022129	AMPLIACION E- MS PG21 PG29	0105	1301	<b>5,854</b>	ud	50	BOLSA	8431927006011
42022936	AMPLIACION E- MS PG29 PG36	0105	1301	<b>10,734</b>	ud	25	BOLSA	8431927006028

**AMPLIACIÓN E-MS Métrica-Métrica**

Ref.	Descripción	SERIE	GTV	€/ud	Unidad Venta	Unidad Embala.	Embalaje	Código EAN
42051216	AMPLIACION E- MS M12 M16	0105	1301	<b>1,188</b>	ud	100	BOLSA	8431927021144
42051620	AMPLIACION E- MS M16 M20	0105	1301	<b>1,732</b>	ud	100	BOLSA	8431927021151
42052025	AMPLIACION E- MS M20 M25	0105	1301	<b>2,783</b>	ud	50	BOLSA	8431927021168
42052532	AMPLIACION E- MS M25 M32	0105	1301	<b>4,516</b>	ud	50	BOLSA	8431927021175
42053240	AMPLIACION E- MS M32 M40	0105	1301	<b>6,648</b>	ud	25	BOLSA	8431927021182
42054050	AMPLIACION E- MS M40 M50	0105	1301	<b>10,901</b>	ud	10	BOLSA	8431927021199
42055063	AMPLIACION E- MS M50 M63	0105	1301	<b>21,637</b>	ud	10	BOLSA	8431927021205

**ADAPTADOR RE-MS Métrica-PG**

Ref.	Descripción	SERIE	GTV	€/ud	Unidad Venta	Unidad Embala.	Embalaje	Código EAN
43001609	ADAPTADOR RE-MS M16 PG 9	0105	1301	<b>4,033</b>	ud	100	BOLSA	8431927021212
43002011	ADAPTADOR RE-MS M20 PG11	0105	1301	<b>4,033</b>	ud	100	BOLSA	8431927021229
43002013	ADAPTADOR RE-MS M20 PG13	0105	1301	<b>4,060</b>	ud	100	BOLSA	8431927021236
43002016	ADAPTADOR RE-MS M20 PG16	0105	1301	<b>5,560</b>	ud	100	BOLSA	8431927021243
43002516	ADAPTADOR RE-MS M25 PG16	0105	1301	<b>9,240</b>	ud	50	BOLSA	8431927021250
43002521	ADAPTADOR RE-MS M25 PG21	0105	1301	<b>7,370</b>	ud	50	BOLSA	8431927021267
43003229	ADAPTADOR RE-MS M32 PG29	0105	1301	<b>14,300</b>	ud	25	BOLSA	8431927021274

**ADAPTADOR RE-MS PG-Métrica**

Ref.	Descripción	SERIE	GTV	€/ud	Unidad Venta	Unidad Embala.	Embalaje	Código EAN
43010916	ADAPTADOR RE-MS PG 9 M16	0105	1301	<b>4,270</b>	ud	100	BOLSA	8431927021281
43011120	ADAPTADOR RE-MS PG11 M20	0105	1301	<b>4,590</b>	ud	100	BOLSA	8431927021298
43011220	ADAPTADOR RE-MS PG13 M20	0105	1301	<b>3,050</b>	ud	100	BOLSA	8431927021304
43011625	ADAPTADOR RE-MS PG16 M25	0105	1301	<b>7,680</b>	ud	50	BOLSA	8431927021311

**TAPON TPK PG GRIS IP68**

Ref.	Descripción	SERIE	GTV	€/ud	Unidad Venta	Unidad Embala.	Embalaje	Código EAN
44020007	TAPON TPK PG 7	0105	1301	<b>0,230</b>	ud	100	BOLSA	8431927006196
44020009	TAPON TPK PG 9	0105	1301	<b>0,230</b>	ud	100	BOLSA	8431927006202
44020011	TAPON TPK PG11	0105	1301	<b>0,231</b>	ud	100	BOLSA	8431927006219
44020013	TAPON TPK PG13	0105	1301	<b>0,235</b>	ud	100	BOLSA	8431927006226
44020016	TAPON TPK PG16	0105	1301	<b>0,291</b>	ud	100	BOLSA	8431927006233
44020021	TAPON TPK PG21	0105	1301	<b>0,387</b>	ud	100	BOLSA	8431927006240
44020029	TAPON TPK PG29	0105	1301	<b>0,764</b>	ud	50	BOLSA	8431927006257
44020036	TAPON TPK PG36	0105	1301	<b>1,654</b>	ud	25	BOLSA	8431927006264

**TAPON TPK Métrica GRIS IP68**

Ref.	Descripción	SERIE	GTV	€/ud	Unidad Venta	Unidad Embala.	Embalaje	Código EAN
44021120	TAPON TPK M12	0105	1301	<b>0,232</b>	ud	100	BOLSA	8431927006295
44021160	TAPON TPK M16	0105	1301	<b>0,241</b>	ud	100	BOLSA	8431927006301
44021200	TAPON TPK M20	0105	1301	<b>0,308</b>	ud	100	BOLSA	8431927006318
44021250	TAPON TPK M25	0105	1301	<b>0,369</b>	ud	100	BOLSA	8431927006325
44021320	TAPON TPK M32	0105	1301	<b>0,602</b>	ud	50	BOLSA	8431927015150
44021400	TAPON TPK M40	0105	1301	<b>0,875</b>	ud	50	BOLSA	8431927015167

**TAPON TPM PG IP68**

Ref.	Descripción	SERIE	GTV	€/ud	Unidad Venta	Unidad Embala.	Embalaje	Código EAN
44010007	TAPON TPM PG 7	0105	1301	<b>0,535</b>	ud	100	BOLSA	8431927006035
44010009	TAPON TPM PG 9	0105	1301	<b>0,689</b>	ud	100	BOLSA	8431927006042
44010011	TAPON TPM PG11	0105	1301	<b>0,924</b>	ud	100	BOLSA	8431927006059
44010013	TAPON TPM PG13	0105	1301	<b>1,014</b>	ud	100	BOLSA	8431927006066
44010016	TAPON TPM PG16	0105	1301	<b>1,225</b>	ud	100	BOLSA	8431927006073
44010021	TAPON TPM PG21	0105	1301	<b>2,275</b>	ud	100	BOLSA	8431927006080
44010029	TAPON TPM PG29	0105	1301	<b>4,110</b>	ud	50	BOLSA	8431927006097
44010036	TAPON TPM PG36	0105	1301	<b>8,864</b>	ud	25	BOLSA	8431927006103
44010042	TAPON TPM PG42	0105	1301	<b>12,685</b>	ud	25	BOLSA	8431927006110
44010048	TAPON TPM PG48	0105	1301	<b>20,710</b>	ud	10	BOLSA	8431927006127

**TAPON TPM Métrica IP68**

Ref.	Descripción	SERIE	GTV	€/ud	Unidad Venta	Unidad Embala.	Embalaje	Código EAN
44011120	TAPON TPM M12	0105	1301	<b>0,742</b>	ud	100	BOLSA	8431927006134
44011160	TAPON TPM M16	0105	1301	<b>0,833</b>	ud	100	BOLSA	8431927015136
44011200	TAPON TPM M20	0105	1301	<b>0,931</b>	ud	100	BOLSA	8431927006141
44011250	TAPON TPM M25	0105	1301	<b>1,912</b>	ud	100	BOLSA	8431927015143
44011320	TAPON TPM M32	0105	1301	<b>3,346</b>	ud	50	BOLSA	8431927006158
44011400	TAPON TPM M40	0105	1301	<b>6,096</b>	ud	25	BOLSA	8431927006165
44011500	TAPON TPM M50	0105	1301	<b>8,678</b>	ud	25	BOLSA	8431927006172
44011630	TAPON TPM M63	0105	1301	<b>16,525</b>	ud	10	BOLSA	8431927006189

**TAPON TPK AIR Métrica Gris**

Ref.	Descripción	SERIE	GTV	€/ud	Unidad Venta	Unidad Embala.	Embalaje	Código EAN
44022120	TAPON TPK AIR M12 016/0.8 GRIS	0105	1301	<b>3,867</b>	ud	100	BOLSA	8431927100856
44022121	TAPON TPK AIR M12 025/0.5 GRIS	0105	1301	<b>3,867</b>	ud	100	BOLSA	8431927100863
44022122	TAPON TPK AIR M12 150/0.2 GRIS	0105	1301	<b>3,867</b>	ud	100	BOLSA	8431927100870
44022123	TAPON TPK AIR M12 300/0.1 GRIS	0105	1301	<b>3,867</b>	ud	100	BOLSA	8431927100887

**TAPON TPK AIR Métrica Negro**

Ref.	Descripción	SERIE	GTV	€/ud	Unidad Venta	Unidad Embala.	Embalaje	Código EAN
44023120	TAPON TPK AIR M12 016/0.8 NEGR	0105	1301	<b>3,867</b>	ud	100	BOLSA	8431927100894
44023121	TAPON TPK AIR M12 025/0.5 NEGR	0105	1301	<b>3,867</b>	ud	100	BOLSA	8431927100900
44023122	TAPON TPK AIR M12 150/0.2 NEGR	0105	1301	<b>3,867</b>	ud	100	BOLSA	8431927100917
44023123	TAPON TPK AIR M12 300/0.1 NEGR	0105	1301	<b>3,867</b>	ud	100	BOLSA	8431927100924

**TAPON TPM AIR Métrica**

Ref.	Descripción	SERIE	GTV	€/ud	Unidad Venta	Unidad Embala.	Embalaje	Código EAN
44013120	TAPON TPM AIR M12 016/0.8	0105	1301	<b>10,113</b>	ud		BOLSA	8431927100771
44013121	TAPON TPM AIR M12 025/0.5	0105	1301	<b>10,113</b>	ud		BOLSA	8431927100795
44013122	TAPON TPM AIR M12 150/0.2	0105	1301	<b>10,113</b>	ud		BOLSA	8431927100818
44013123	TAPON TPM AIR M12 300/0.1	0105	1301	<b>10,113</b>	ud		BOLSA	8431927100832

**TAPON TPM AIR INOX Métrica**

Ref.	Descripción	SERIE	GTV	€/ud	Unidad Venta	Unidad Embala.	Embalaje	Código EAN
44014120	TAPON TPM AIR-INOX M12 016/0.8	0105	1301	Consultar	ud		BOLSA	8431927100788
44014121	TAPON TPM AIR-INOX M12 025/0.5	0105	1301	Consultar	ud		BOLSA	8431927100801
44014122	TAPON TPM AIR-INOX M12 150/0.2	0105	1301	Consultar	ud		BOLSA	8431927100825
44014123	TAPON TPM AIR-INOX M12 300/0.1	0105	1301	Consultar	ud		BOLSA	8431927100849

**FUNDA PROTECTORA PA GRIS**

Ref.	Descripción	SERIE	GTV	€/m	Unidad Venta	Unidad Embala.	Embalaje	Código EAN
12000004	FUNDA PROTE PA DN 4 (3/ 6) GRIS	0105	1401	<b>3,275</b>	m	100	ROLLO	8431927021977
12000006	FUNDA PROTE PA DN 6 (5/ 8) GRIS	0105	1401	<b>3,337</b>	m	100	ROLLO	8431927021984
12000008	FUNDA PROTE PA DN 8 (7/11) GRIS	0105	1401	<b>4,213</b>	m	100	ROLLO	8431927021991
12000010	FUNDA PROTE PA DN10 (7/15) GRIS	0105	1401	<b>5,377</b>	m	100	ROLLO	8431927022004
12000012	FUNDA PROTE PA DN12 (8/18) GRIS	0105	1401	<b>6,335</b>	m	100	ROLLO	8431927022011
12000016	FUNDA PROTE PA DN16 (15/21) GRIS	0105	1401	<b>8,590</b>	m	100	ROLLO	8431927022028
12000020	FUNDA PROTE PA DN20 (18/30) GRIS	0105	1401	<b>11,351</b>	m	100	ROLLO	8431927022035
12000025	FUNDA PROTE PA DN25 (24/36) GRIS	0105	1401	<b>13,689</b>	m	100	ROLLO	8431927022042
12000030	FUNDA PROTE PA DN30 (32/47) GRIS	0105	1401	<b>16,593</b>	m	50	ROLLO	8431927022059
12000040	FUNDA PROTE PA DN40 (32/58) GRIS	0105	1401	<b>24,020</b>	m	50	ROLLO	8431927022066
12000050	FUNDA PROTE PA DN50 (32/68) GRIS	0105	1401	<b>27,666</b>	m	50	ROLLO	8431927022073
12000060	FUNDA PROTE PA DN60 (32/85) GRIS	0105	1401	<b>31,817</b>	m	50	ROLLO	8431927022080

**FUNDA PROTECTORA PA NEGRO**

Ref.	Descripción	SERIE	GTV	€/m	Unidad Venta	Unidad Embala.	Embalaje	Código EAN
12000104	FUNDA PROTE PA DN 4 (3/ 6) NEGR	0105	1401	<b>3,275</b>	m	100	ROLLO	8431927022097
12000106	FUNDA PROTE PA DN 6 (5/ 8) NEGR	0105	1401	<b>3,337</b>	m	100	ROLLO	8431927022103
12000108	FUNDA PROTE PA DN 8 (7/11) NEGR	0105	1401	<b>4,213</b>	m	100	ROLLO	8431927022110
12000110	FUNDA PROTE PA DN10 (7/15) NEGR	0105	1401	<b>5,377</b>	m	100	ROLLO	8431927022127
12000112	FUNDA PROTE PA DN12 (8/18) NEGR	0105	1401	<b>6,335</b>	m	100	ROLLO	8431927022134
12000116	FUNDA PROTE PA DN16 (15/21) NEGR	0105	1401	<b>8,590</b>	m	100	ROLLO	8431927022141
12000120	FUNDA PROTE PA DN20 (18/30) NEGR	0105	1401	<b>11,351</b>	m	100	ROLLO	8431927022158
12000125	FUNDA PROTE PA DN25 (24/36) NEGR	0105	1401	<b>13,689</b>	m	100	ROLLO	8431927022165
12000130	FUNDA PROTE PA DN30 (32/47) NEGR	0105	1401	<b>16,593</b>	m	50	ROLLO	8431927022172
12000140	FUNDA PROTE PA DN40 (32/58) NEGR	0105	1401	<b>24,020</b>	m	50	ROLLO	8431927022189
12000150	FUNDA PROTE PA DN50 (32/68) NEGR	0105	1401	<b>27,666</b>	m	50	ROLLO	8431927022196
12000160	FUNDA PROTE PA DN60 (32/85) NEGR	0105	1401	<b>31,817</b>	m	50	ROLLO	8431927022202

**FUNDA PROTECTORA PP GRIS**

Ref.	Descripción	SERIE	GTV	€/m	Unidad Venta	Unidad Embala.	Embalaje	Código EAN
12001004	FUNDA PROTE PP DN 4 (3/ 6) GRIS	0105	1401	<b>2,163</b>	m	100	ROLLO	8431927022219
12001006	FUNDA PROTE PP DN 6 (5/ 8) GRIS	0105	1401	<b>3,100</b>	m	100	ROLLO	8431927022226
12001008	FUNDA PROTE PP DN 8 (7/11) GRIS	0105	1401	<b>3,760</b>	m	100	ROLLO	8431927022233
12001010	FUNDA PROTE PP DN10 (7/15) GRIS	0105	1401	<b>5,078</b>	m	100	ROLLO	8431927022240
12001012	FUNDA PROTE PP DN12 (8/18) GRIS	0105	1401	<b>6,211</b>	m	100	ROLLO	8431927022257
12001016	FUNDA PROTE PP DN16 (15/21) GRIS	0105	1401	<b>8,178</b>	m	100	ROLLO	8431927022264
12001020	FUNDA PROTE PP DN20 (18/30) GRIS	0105	1401	<b>10,341</b>	m	100	ROLLO	8431927022271
12001025	FUNDA PROTE PP DN25 (24/36) GRIS	0105	1401	<b>13,452</b>	m	100	ROLLO	8431927022288
12001030	FUNDA PROTE PP DN30 (32/47) GRIS	0105	1401	<b>15,893</b>	m	50	ROLLO	8431927022295
12001040	FUNDA PROTE PP DN40 (32/58) GRIS	0105	1401	<b>23,237</b>	m	50	ROLLO	8431927022301
12001050	FUNDA PROTE PP DN50 (32/68) GRIS	0105	1401	<b>26,626</b>	m	50	ROLLO	8431927022318
12001060	FUNDA PROTE PP DN60 (32/85) GRIS	0105	1401	<b>30,776</b>	m	50	ROLLO	8431927022325

**CINTA HELICOIDAL BLANCA**

Ref.	Descripción	SERIE	GTV	€/m	Unidad Venta	Unidad Embala.	Embalaje	Código EAN
91011030	CINTA HELICOIDAL BLANCA (3/12)	0105	1401	<b>0,525</b>	m	25	BOLSA	8431927012210
91021060	CINTA HELICOIDAL BLANCA (6/40)	0105	1401	<b>0,620</b>	m	25	BOLSA	8431927012234
91031080	CINTA HELICOIDAL BLANCA (8/60)	0105	1401	<b>1,050</b>	m	25	BOLSA	8431927012258
91041109	CINTA HELICOIDAL BLANCA (10/90)	0105	1401	<b>1,229</b>	m	25	BOLSA	8431927012272

**CINTA HELICOIDAL NEGRO**

Ref.	Descripción	SERIE	GTV	€/m	Unidad Venta	Unidad Embala.	Embalaje	Código EAN
91012030	CINTA HELICOIDAL NEGR (3/12)	0105	1401	<b>0,567</b>	m	25	BOLSA	8431927012227
91022060	CINTA HELICOIDAL NEGR (6/40)	0105	1401	<b>0,725</b>	m	25	BOLSA	8431927012241
91032080	CINTA HELICOIDAL NEGR (8/60)	0105	1401	<b>1,229</b>	m	25	BOLSA	8431927012265
91042109	CINTA HELICOIDAL NEGR (10/90)	0105	1401	<b>1,743</b>	m	25	BOLSA	8431927012289



rejiband®

pemsa

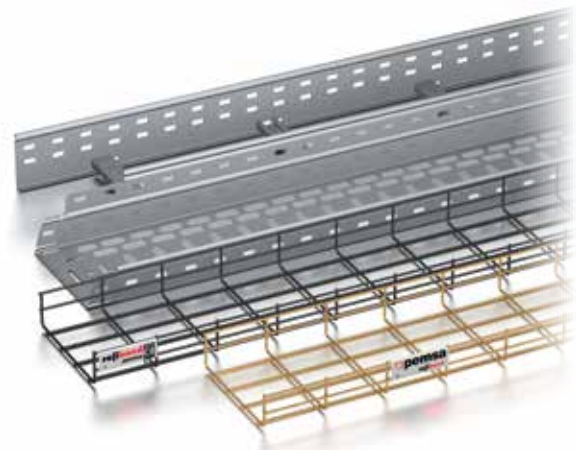

Sistemas de Bandejas y Soportes.  
Guía de selección

Cable Tray and Supports System.  
Selection guide

Sistemas de Caminhos de Cabos  
e Suportes. Guia de Seleção

Sistemas de Bandejas Portacables / Cable Tray System / Caminho de Cabos

Denominación Designation Designação	rejiband®	rejiband® BLACK C8	rejiband® CLICK	rejitech®	pemsaband® SX(*) / LX	pemsaband® RX	megaband®	pemsaband® PQ / PQ AL

Características / Features / Características

	Acero al carbono / Carbon steel / Aço Carbono							Aluminio / Aluminium
Ⓜ								
PG					•	•	•	
EZ	•		•	•				
BYCRO	•		•	•			•	
GC	•				•	•	•	•
C8		•	•	•				
304	•				•		•	
316L	•				•			
mm	60-600	60-600	60-600	60-200	100-600	100-600	100-1000	50-600
mm	35/60/110	60-100	60-100	60-100	60/85/100	60/85/100	60/85/100/120	15/30/50/60/100
	-50 °C / +150 °C							
N/m								
	20 J.							
	A1 / E90			A1	A1 / E90	A1	A1	A1

Homologaciones / Approvals / Homologações

Aplicaciones / Applications / Aplicações

	•	•	•	•	•	•	•	•	•
	•	•			•	•	•		
	•	•	•	•	•	•			
	•	•			•	•	•	•	•
	•				•				
	•				•	•	•	•	•
	13-14	12	12	15	24-25-26	26	37-38	CONSULTAR	



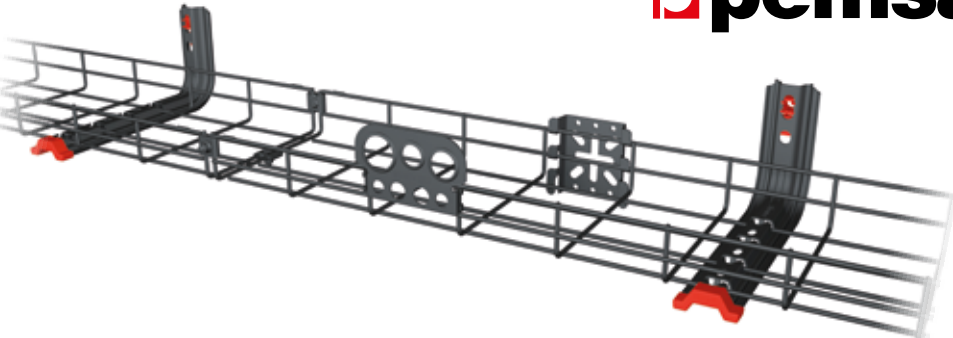

Sistemas de Bandejas y Soportes.  
Guía de selección

Cable Tray and Supports System.  
Selection guide

Sistemas de Caminhos de Cabos  
e Suportes. Guia de Seleção

Sistemas de Soportes / Supports Systems / Sistemas de Suportes

Soportes Wall Bracket Suportes Omega SPLUS	Soportes Techo Ceiling Bracket Suportes Tecto Omega SPLUS	Suspensión Channel Suspensão Omega SPLUS+	Soportes Reforzados Med. Duty Cantilever Suporte Reforçado RPLUS	Sop. Muy Reforzados Heavy Duty Cantl. Sup. muito Reforçado RPLUS	Distanciadores Stand off Bracket Distanciadores	Railes y Accesorios Channel & Accessories Perfis e Acessórios	Denominación Designation Designação

Características / Features / Características

Acero al carbono / Carbon steel / Aço Carbono

							(M)
•	•	•	•		•	•	PG
							EZ
							BYCRO
•	•	•	•	•	•	•	GC
•	•	•	•	•	•	•	C8
•	•	•	•	•	•	•	304
•	•	•	•	•	•	•	316L
100-400	100-400	100-600	100-600	300-600	100-300	41X21 41X21	mm
						3 M	mm
							°C
							°C
							N/m
A1 / E90	A1 / E90	A1 / E90	A1 / E90	A1 / E90	A1	A1 / E90	

Homologaciones / Approvals / Homologações

--	--	--	--	--	--	--	--

Aplicaciones / Applications / Aplicações

•			•	•			
•			•	•		•	
	•					•	
		•			•	•	
•	•		•	•		•	
		•			•	•	
46	46	48	46-47	48	22, 50	53-54	

Montaje / Assembly / Montagem

	A pared Wall Em parede		A pared con rail Wall with channel Em parede com perfil		A techo Ceiling Em tecto		A techo con varillas Ceiling with threaded rods Em tecto com varão		A techo con péndulo Ceiling with pendant Em tecto com péndulo		Instalación a suelo Floor installations No chão
--	------------------------------	--	---	--	--------------------------------	--	--	--	---	--	---



## Pedidos:

Se consideran en firme. Importe mínimo 200 € netos.

## Ampliaciones de pedido:

La ampliación de cualquier pedido solo podrá ser aceptada como tal, si el pedido original no ha sido expedido.

## Embalajes:

Sólo se suministrarán embalajes completos. Las cantidades indicadas no pueden fraccionarse. Conforme a la ley 11/1997 de 24 de abril de Envases y Residuos de Envases, el poseedor final del producto y de envase industrial será el responsable de su entrega o la de sus residuos para la correcta gestión medioambiental.

## Precios:

Se aplicarán los vigentes en la fecha de suministro. Precios válidos durante los 30 días posteriores a la fecha de la oferta, salvo aumento de tarifa de precios vigentes distinta o de coste de mano de obra y/o materias primas Precios sólo válidos para el total de las cantidades incluidas en la presente oferta y con suministros a través de distribuidor clasificado por PEMSA. Plazos de entrega: consultar en el momento de realización del pedido.

## I.V.A. y otros Impuestos:

No están incluidos en los precios.

## Portes pagados:

Pedidos con destino a Puntos de venta en Madrid, Guadalajara, Toledo, Ciudad Real, Cuenca, Ávila y Segovia Pagados para importes superiores a 300 €, mediante compañías designadas por PEMSA en único envío.

Pedidos con destino a Puntos de Venta en otras provincias de Península y Baleares: Pagados para importes superiores a 600 € netos, mediante compañías designadas por PEMSA en único envío.

Pedidos con condiciones especiales de entrega en obra en Península y Baleares: Pagados para importes superiores a 2.000 € netos, mediante compañías designadas por PEMSA en único envío.

Pedidos con destino a Canarias: Pagados para importes superiores a 3.000 € netos, mediante compañías designadas por PEMSA en único envío.

## Portes debidos:

Pedidos para importes inferiores a los arriba indicados, servicios urgentes y compañías de transporte distintas a las habituales de PEMSA que deberán ser gestionadas por el cliente.

## Condiciones Generales de suministro a través de distribuidor clasificado por PEMSA embalajes:

Sólo se suministrarán embalajes completos. Las cantidades indicadas no pueden fraccionarse. Conforme a la ley 11/1997 de 24 de abril de Envases y Residuos de Envases, el poseedor final del producto y de envase industrial será el responsable de su entrega o la de sus residuos para la correcta gestión medioambiental.

## Incidencias en transporte:

En caso de no conformidades referidas a cantidad, deterioro, extravío, u otras relativas al transporte de la mercancía recibida, el receptor de la mercancía, deberá hacer constar en el talón o recibo de la compañía de transporte una descripción detallada de las incidencias producidas. Toda incidencia deberá ser comunicada por escrito a PEMSA en un plazo no superior a 24 horas.

## Reclamaciones:

Sólo se aceptarán sobre la mercancía, y en un periodo no superior a 15 días después de su recepción. Toda reclamación deberá ser tramitada con el Dpto. de Atención al Cliente. En productos Galvanizados en Caliente, no serán motivo de reclamación las diferencias de aspecto superficial según la siguiente consideración:

El galvanizado en caliente NO ES UN ACABADO ESTÉTICO NI DE PRECISIÓN. Es una muy eficaz protección contra la corrosión. PUEDE PRESENTAR DIFERENCIAS DE COLOR (tonalidades de Gris), BRILLO y ACABADO SUPERFICIAL (rugosidad, uniformidad), motivadas por el proceso empleado, QUE SON NORMALES, y que NO AFECTAN A LA CALIDAD Y DURACION DE LA PROTECCION ANTI-CORROSIÓN.

## Devoluciones:

• No se admitirán devoluciones de materiales entregados directamente en obra (o instalaciones) conforme a instrucciones previas del cliente

• No se admitirán devoluciones de materiales transcurridos 90 días desde la fecha de entrega en las instalaciones del cliente. Sólo se abonarán aquellos materiales aptos para reincorporación en stock y posterior venta, con embalajes completos definidos en la tarifa vigente.

• No se admitirán devoluciones de materiales especiales. Se consideran materiales especiales los no incluidos en catálogo o listas de precios vigentes, y los fabricados y/o diseñados según características solicitadas por el cliente. Se consideran también materiales especiales la Bandeja PEMSABAND de las gamas RX, gama Petroquímica PQu y PQw, y todos los accesorios de la gama MEGABAND, así como todos los materiales en acero INOXIDABLE 304 o 316L, ALUMINIO y acabado especiales en base a pinturas y resinas epoxi.

• No se admiten devoluciones de materiales descatalogados (no incluidos en catálogo o listas de precios vigentes).

• No se admitirán devoluciones sin la aceptación previa y por escrito del Dpto. de Atención al Cliente.

• Admitida la devolución por PEMSA, el cliente recibirá una aceptación por escrito indicando las condiciones de la devolución:

- Se asignará un N° RMA que deberá de ser consignado por el cliente en toda la documentación de envío.

- La vigencia de esta autorización será de 15 días, durante el transcurso de los cuales, el material deberá de ser remitido a PEMSA.

- La devolución se remitirá exclusivamente a nuestras instalaciones en: c/ Galileo Galilei, 22 -24, Parque Empresarial La Garena – 28806 Alcalá de Henares (Madrid).- Horario de 9.00 a 13.00 hrs.

- Los portes de las devoluciones serán siempre por cuenta del cliente.

- Depreciación: Toda devolución por causas no imputables a PEMSA, de productos contenidos en este catalogo/tarifa, sufrirá una depreciación mínima del 15% sobre el valor del material en el momento de su venta.

- La devolución del material implica por parte del cliente la aceptación de las condiciones aquí detalladas.

## Reserva de dominio:

PEMSA mantiene una reserva de dominio sobre el material suministrado, hasta el total pago de la factura correspondiente.

LOS TRIBUNALES DE MADRID serán los únicos competentes en toda acción o divergencia.

LA RESPONSABILIDAD CIVIL sobre nuestros productos, caduca al año de su suministro, siempre que su manipulación haya sido correcta. PEMSA declina toda responsabilidad derivada del uso inadecuado de sus productos.

PEQUEÑO MATERIAL ELECTRICO, S.A.U (PEMSA) HACE TODO CUANTO ESTÁ EN SU MANO PARA GARANTIZAR LA CORRECCIÓN DE TODA LA INFORMACIÓN DE ESTA LISTA DE PRECIOS EN EL MOMENTO DE SU IMPRESIÓN. PEMSA BUSCA CONSTANTEMENTE FORMAS DE MEJORAR Y, POR ELLO, SE RESERVA EL DERECHO DE EFECTUAR CAMBIOS EN CUALQUIER MOMENTO Y SIN PREVIO AVISO EN LOS PRECIOS, MATERIALES Y ESPECIFICACIONES DE SUS PRODUCTOS.

## ESTA TARIFA DE PRECIOS ANULA TODAS LAS ANTERIORES

Rejilband, Pemsaband, Inducanal, Rejitech, Megaband y Pemsaflex son marcas registradas propiedad de "Pemsa Cable Management, S.A."





FÁBRICA, OFICINAS Y ALMACENES CENTRALES / HEAD OFFICE, MANUFACTURING AND CENTRAL STORE / UNSINE, BUREAUX, ENTERPOTS:

C/ Galileo Galilei, 22-24. P.E. La Garena  
28806 Alcalá de Henares. Madrid  
Tel.: 91 802 34 88 / Fax: 91 802 33 81  
info@pemsa-rejiband.com

ATENCIÓN AL CLIENTE / CUSTOMER SERVICE:

Tel.: 91 802 01 20 / Fax: 91 802 33 82  
atencionalcliente@pemsa-rejiband.com

DELEGACIONES

**DELEGACIÓN CENTRO**

centro@pemsa-rejiband.com

**DELEGACIÓN NORTE**

norte@pemsa-rejiband.com

**DELEGACIÓN SUR**

sur@pemsa-rejiband.com

**DELEGACIÓN ESTE**

este@pemsa-rejiband.com

**DELEGACIÓN NORESTE**

noreste@pemsa-rejiband.com

OFICINA DE EXPORTACIÓN / EXPORT OFFICE / SERVICE EXPORT:

Tel.: +34 91 802 34 99 / Fax: +34 91 802 34 82  
export@pemsa-rejiband.com

FILIALES / SUBSIDIARIES / FILIALES:

**PEMSA UK**

1 Sussex Avenue  
LEEDS LS10 2LF  
Tel.: +44 113 277 9090  
Fax: +44 113 277 5939  
sales@pemsa.co.uk

**PEMSA FRANCIA**

12, Rue de la Closerie, ZI de Clos aux pois  
Bât G, LISSES, France  
Tel.: +33 01 60 86 75 65 / Fax: +33 01 60 87 11 83  
service-client@pemsa.fr

**PEMSA PORTUGAL**

Estrada da Polima, 1007 - 2º K  
2785-543 São Domingos de Rana. Portugal  
Tel.: +351 21 4445725 / Fax: +351 21 4445727  
pemsa.portugal@pemsa-rejiband.com

**PEMSA LATINOAMÉRICA SAS**

Vía Funza - Siberia, Km 1,5  
Parque Ind. VIC - Bodega 1.  
FUNZA (Bogotá) - COLOMBIA  
Tél.: +57 1 823 75 20 / Fax: +57 1 823 75 18  
info@pemsa.com.co  
www.pemsa.com.co



[www.pemsa-rejiband.com](http://www.pemsa-rejiband.com)